



**YAMAHA**



**2010 WaveRunner  
FX SHO  
FX Cruiser SHO**

**OWNER'S/OPERATOR'S MANUAL**

**▲ Read this manual carefully  
before operating this watercraft.**

---

**YAMAHA MOTOR CO., LTD.**  
F1W-F8199-72-E0

**Read this manual carefully before operating this watercraft. This manual should stay with the WaveRunner if it is sold.**

# Important manual information

---

EJU37152

## Declaration of Conformity for Personal Watercraft (PWC) with the requirements of Directive 94/25/EC as amended by Directive 2003/44/EC

Revision No:

**Name of PWC manufacturer:**

YAMAHA MOTOR CO., LTD.

---

**Address:** 2500 Shingai

---

**Town:** Iwata, Shizuoka **Post Code:** 438-8501

---

**Country:** Japan

---

**Name of Authorized Representative** (if applicable):

YAMAHA MOTOR EUROPE N.V.

---

**Address:** Koolhovenlaan 101

---

**Town:** Schiphol-Rijk **Post Code:** 1119 NC

---

**Country:** The Netherlands

---

**Name of Notified Body for noise emission assessment:** Luxcontrol SA

---

**Address:** 1, avenue des Terres Rouges BP 349

---

**Town:** Esch-sur-Alzette **Post Code:** L-4004

---

**Country:** Luxembourg **ID Number:** 0882

---

**Name of Notified Body for exhaust emission assessment:** Luxcontrol SA

---

**Address:** 1, avenue des Terres Rouges BP 349

---

**Town:** Esch-sur-Alzette **Post Code:** L-4004

---

**Country:** Luxembourg **ID Number:** 0882

---

**ECtype-examination Certificate number** (if applicable): LC\*2003/44\*10026

---

# Important manual information

## Conformity assessment modules used:

for construction: A  Aa  B+C  B+D  B+E  B+F  G  H

for noise emissions: Aa  G  H

for exhaust emissions: B+C  B+D  B+E  B+F  G  H

## Other Community Directives applied:

**Directive 89/336/EEC relating to electromagnetic compatibility (EMC), using the following standards, for emission CISPR12:2001, for generic immunity EN61000-6-2:2001**

## DESCRIPTION OF CRAFT

Craft model Identification Number, starting from

U S - Y A M A 1 0 0 1 G 9 1 0 -

Model name / Commercial name :

Design Category:  C  D

**FX1800A-J / FX Cruiser SHO, FX1800-J / FX SHO**

## IDENTIFICATION OF ENGINE(S) COVERED BY THIS DECLARATION OF CONFORMITY

Combustion cycle:  2 stroke  4 stroke

Unique engine identification number(s) or engine family code(s)	EC Type-examination certificate (for exhaust)
6S5	LC*2003/44*10026

ESSENTIAL REQUIREMENTS	standards	other normative document/method	technical file	Please specify in more detail (* = mandatory standard)
I.A design and construction	<input checked="" type="checkbox"/>	<input type="checkbox"/>	<input checked="" type="checkbox"/>	EN ISO 13590
I.B exhaust emissions	<input checked="" type="checkbox"/> *	<input type="checkbox"/>	<input checked="" type="checkbox"/>	*EN ISO 8178-1:1996
I.C noise emissions	<input checked="" type="checkbox"/> *	<input type="checkbox"/>	<input checked="" type="checkbox"/>	*EN ISO 14509

This declaration of conformity is issued under the sole responsibility of the PWC manufacturer. I declare on behalf of the PWC manufacturer that the craft model and engine(s) mentioned above comply with all applicable essential requirements in the way specified and are in conformity with the type for which above mentioned EC type-examination certificate(s) has(have) been issued.

**Name / title:** S. Hayakawa / President of YAMAHA MOTOR EUROPE N.V.

(identification of the person empowered to sign on behalf of the PWC manufacturer or his authorized representative)

Signature:  \_\_\_\_\_  
(or an equivalent marking)

**Date and place of issue:** 1st / July / 2009, Schiphol-Rijk, The Netherlands

# Important manual information

EJU30192

## To the owner/operator

Thank you for choosing a Yamaha watercraft. This owner's/operator's manual contains information you will need for proper operation, maintenance, and care. If you have any questions about the operation or maintenance of your watercraft, please consult a Yamaha dealer.

This manual is not a course on boating safety or seamanship. If this is your first watercraft, or if you are changing to a type of watercraft you are not familiar with, for your own comfort and safety, please ensure that you obtain proper training or practice before operating the watercraft by yourself. In addition, a Yamaha dealer or boating organization will be pleased to recommend local sea schools, or competent instructors.

In this manual, information of particular importance is distinguished in the following ways:



This is the safety alert symbol. It is used to alert you to potential personal injury hazards. Obey all safety messages that follow this symbol to avoid possible injury or death.

EWJ00071



### **WARNING**

**A WARNING indicates a hazardous situation which, if not avoided, could result in death or serious injury.**

ECJ00091

### **NOTICE**

**A NOTICE indicates special precautions that must be taken to avoid damage to the watercraft or other property.**

### **TIP:**

A TIP provides key information to make procedures easier or clearer.

EJU40410

Because Yamaha has a policy of continuing product improvement, this product may not be exactly as described in this owner's/operator's manual. Specifications are subject to change without notice.

This manual should be considered a permanent part of this watercraft and should remain with it even if the watercraft is subsequently sold.

EJU30232

**WaveRunner FX SHO/FX Cruiser SHO  
OWNER'S/OPERATOR'S MANUAL  
©2009 by Yamaha Motor Co., Ltd.  
1st Edition, May 2009  
All rights reserved.  
Any reprinting or unauthorized use  
without the written permission of  
Yamaha Motor Co., Ltd.  
is expressly prohibited.  
Printed in U.S.A.**

# Table of contents

---

<b>General and important labels</b> .....	<b>1</b>	<b>Watercraft operation</b> .....	<b>32</b>
Identification numbers .....	1	Watercraft operation functions .....	32
Primary Identification (PRI-ID)		Reverse system .....	32
number .....	1	Quick Shift Trim System	
Craft Identification Number (CIN) .....	1	(Q.S.T.S.) .....	33
Engine serial number .....	1	Watercraft operation modes .....	34
Model information .....	2	Low RPM Mode .....	34
Builder's plate .....	2	No-wake mode .....	35
Important labels .....	3	Cruise assist .....	36
Warning labels .....	4		
Other labels .....	8		
<b>Safety information</b> .....	<b>10</b>	<b>Instrument operation</b> .....	<b>39</b>
Limitations on who may operate		Multifunction information center ...	39
the watercraft .....	10	Analog speedometer/tachometer ...	39
Cruising limitations .....	11	Information display .....	40
Operation requirements .....	12	Multifunction display	
Recommended equipment .....	14	(FX Cruiser SHO) .....	44
Hazard information .....	15	<b>Equipment operation</b> .....	<b>47</b>
Watercraft characteristics .....	15	Equipment .....	47
Water-skiing .....	17	Seats .....	47
Safe boating rules .....	19	Handgrip .....	48
Enjoy your watercraft		Reboarding step .....	48
responsibly .....	19	Bow eye .....	49
		Stern eyes .....	49
		Cleat .....	49
		Pull-up cleats (FX Cruiser SHO) .....	50
		Storage compartments .....	50
		Fire extinguisher container .....	53
<b>Description</b> .....	<b>21</b>	<b>Operation and handling</b>	
Watercraft glossary .....	21	<b>requirements</b> .....	<b>54</b>
Location of main components .....	22	Fuel requirements .....	54
		Fuel .....	54
<b>Control function operation</b> .....	<b>26</b>	Engine oil requirements .....	56
Watercraft control functions .....	26	Engine oil .....	56
Remote control transmitter .....	26	Draining the bilge water .....	57
Yamaha Security System .....	27	Draining the bilge water on land .....	57
Engine stop switch .....	28	Draining the bilge water on water ...	58
Engine shut-off switch .....	28		
Start switch .....	28		
Throttle lever .....	29		
Steering system .....	29		
Adjustable tilt steering system .....	30		
Cooling water pilot outlets .....	30		
Water separator .....	31		

# Table of contents

Transporting on a trailer .....	59	Rustproofing .....	88
<b>First-time operation.....</b>	<b>60</b>	<b>Maintenance .....</b>	<b>89</b>
Engine break-in .....	60	Maintenance .....	89
<b>Pre-operation checks.....</b>	<b>61</b>	Tool kit .....	89
Pre-operation checklist .....	61	Removing and installing the engine cover .....	89
Pre-operation check points .....	63	Periodic maintenance chart .....	91
Pre-launch checks .....	63	Engine oil and oil filter .....	92
Post-launch checks .....	69	<b>Specifications.....</b>	<b>93</b>
<b>Operation .....</b>	<b>71</b>	Specifications.....	93
Operating your watercraft .....	71	<b>Trouble recovery.....</b>	<b>94</b>
Getting to know your watercraft .....	71	Troubleshooting .....	94
Learning to operate your watercraft .....	71	Troubleshooting chart .....	94
Riding position .....	72	Emergency procedures .....	97
Launching the watercraft .....	72	Cleaning the jet intake and impeller .....	97
Starting the engine on water .....	72	Jumping the battery .....	98
Stopping the engine .....	73	Replacing the fuses .....	98
Leaving the watercraft .....	73	Towing the watercraft .....	100
Operating the watercraft .....	73	Submerged watercraft .....	100
Turning the watercraft .....	74		
Stopping the watercraft .....	75		
Operating the watercraft in reverse .....	76		
Boarding the watercraft .....	76		
Starting off .....	79		
Capsized watercraft .....	80		
Beaching and docking the watercraft .....	81		
Operating in weeded areas .....	82		
After removing the watercraft from the water .....	82		
<b>Care and storage.....</b>	<b>83</b>		
Post-operation care .....	83		
Flushing the cooling water passages .....	83		
Cleaning the watercraft .....	84		
Battery care .....	84		
Long-term storage .....	87		
Cleaning .....	87		
Lubrication .....	87		

# General and important labels

EJU36450

## Identification numbers

Record the Primary Identification (PRI-ID) number, Craft Identification Number (CIN), and engine serial number in the spaces provided for assistance when ordering spare parts from a Yamaha dealer. Also record and keep these ID numbers in a separate place in case your watercraft is stolen.

EJU30283

### Primary Identification (PRI-ID) number

The PRI-ID number is stamped on a plate attached inside the engine compartment. (See page 47 for seat removal and installation procedures and page 52 for information on the seat storage compartment.)

#### MODEL:

FX1800-J (FX SHO)

FX1800A-J (FX Cruiser SHO)

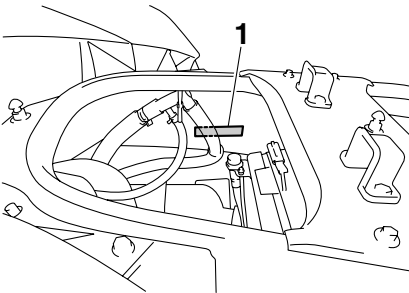

1 Primary Identification (PRI-ID) number location

MODEL	<input type="text"/>	PRI-ID.	<input type="text"/>
		<b>F1W</b>	<input type="text"/>
<small>YAMAHA MOTOR CO., LTD.          ASSEMBLED IN U.S.A. FROM AMERICAN AND JAPANESE COMPONENTS.          ASSEMBLÉ AUX ÉTATS-UNIS DE PIÈCES AMÉRICAINES ET JAPONAISES.</small>			

**F1W** -

EJU36550

### Craft Identification Number (CIN)

The CIN is stamped on a plate attached to the aft deck.

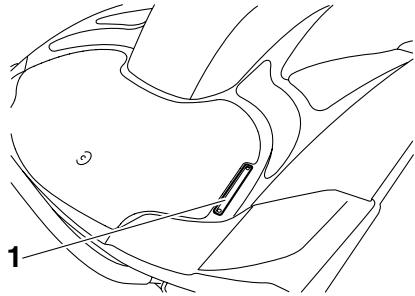

1 Craft Identification Number (CIN) location

**US - YAM**

EJU40470

### Engine serial number

The engine serial number is stamped on a plate attached to the engine unit. (See page 47 for seat removal and installation procedures and page 89 for engine cover removal and installation procedures.)

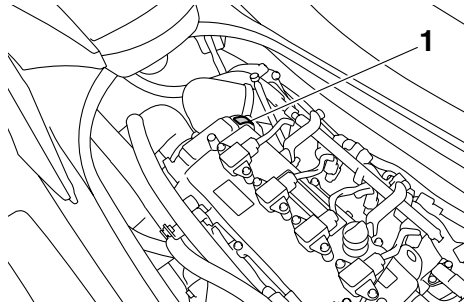

1 Engine serial number location

**YAMAHA**

**YAMAHA MOTOR CO., LTD.  
 MADE IN JAPAN  
 PAYS D'ORIGINE JAPON**



# General and important labels

EJU30320

## Model information

EJU30331

### Builder's plate

Watercraft with this label conform to certain portions of the European Parliament directive relating to machinery.

Part of the information is given on the builder's plate affixed on the craft. A full explanation of this information is given in the relevant sections of this manual.

### TIP:

The significant wave height is the mean height of the highest one-third of the waves, which approximately corresponds to the wave height estimated by an experienced observer. However, some waves will be double this height.

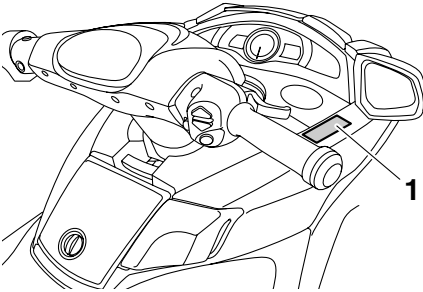

1 Builder's plate location

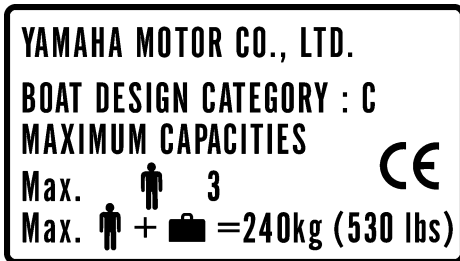

**Design category of this personal watercraft: C**

### Category C:

This watercraft is designed to operate in winds up to Beaufort force 6 and the associated wave heights (significant wave heights up to 2 m (6.56 ft); see the following TIP). Such conditions may be encountered in exposed inland waters, in estuaries, and in coastal waters in moderate weather conditions.

# General and important labels

EJU30452

## Important labels

Read the following labels before using this watercraft. If have any questions, consult a Yamaha dealer.

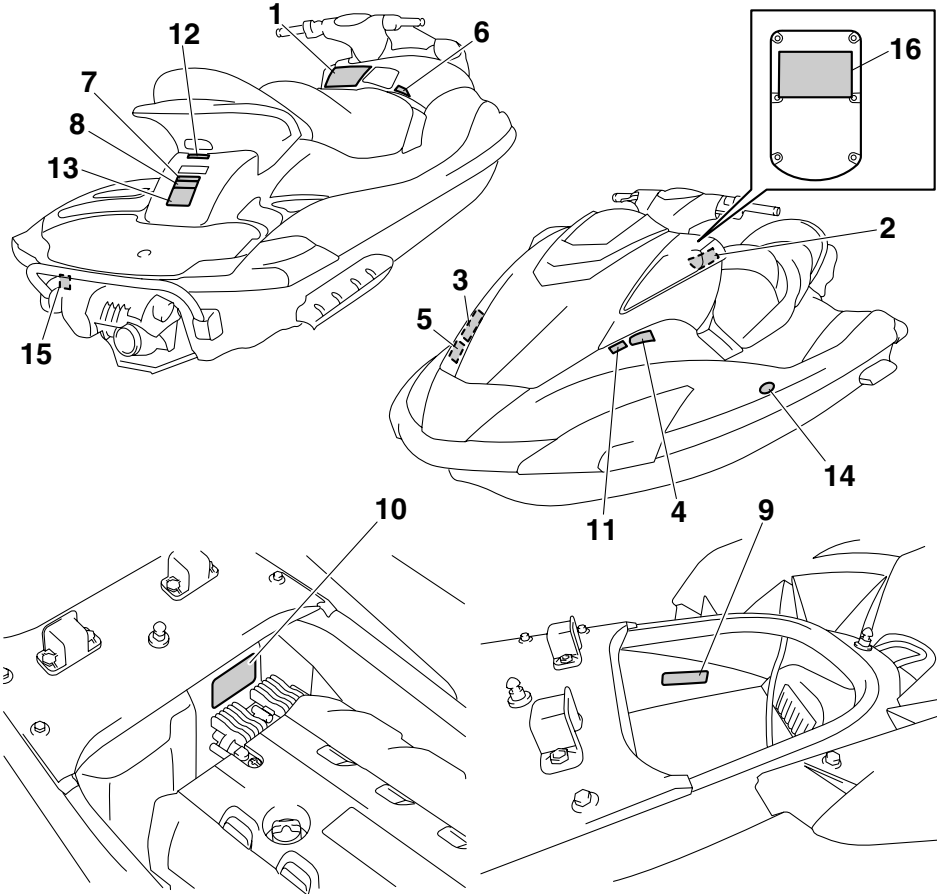

# General and important labels

EJU35912

## Warning labels

If any of these labels are damaged or missing, contact a Yamaha dealer for replacements.

1

**⚠ WARNING**

To reduce the risk of SEVERE INJURY or DEATH:

**WEAR A PERSONAL FLOTATION DEVICE (PFD).**  
All riders must wear an authority-approved PFD that is suitable for personal watercraft (PWC) use.

**WEAR PROTECTIVE CLOTHING.** Severe internal injuries can occur if water is forced into body cavities as a result of falling into water or being near jet thrust nozzle. Normal swimwear does not adequately protect against forceful water entry into rectum or vagina. All riders must wear a wet suit bottom or clothing that provides equivalent protection (See Owner's Manual).

Footwear, gloves, and goggles/glasses are recommended.

**KNOW BOATING LAWS.** Yamaha Motor Co., Ltd. recommends a minimum operator age of 16 years old. Know the operator age and training requirements for your state. A boating safety course is recommended and may be required in your state.

**ATTACH ENGINE SHUT-OFF CORD (LANYARD)** to wrist and keep it free from handlebars so that engine stops if operator falls off. After riding, remove cord from PWC to avoid unauthorized use by children or others.

**RIDE WITHIN YOUR LIMITS AND AVOID AGGRESSIVE MANEUVERS** to reduce the risk of loss of control, ejection, and collision. This is a high performance boat – not a toy. Sharp turns or jumping wakes or waves can increase the risk of back/spinal injury (paralysis), facial injuries, and broken legs, ankles, and other bones.  
Do not jump wakes or waves.

**DO NOT APPLY THROTTLE WHEN ANYONE IS AT REAR OF PWC**—turn engine off or keep engine at idle. Water and/or debris exiting jet thrust nozzle can cause severe injury.

**⚠ WARNING**

**KEEP AWAY FROM INTAKE GRATE** while engine is on. Items such as long hair, loose clothing, or PFD straps can become entangled in moving parts resulting in severe injury or drowning.

**NEVER RIDE AFTER CONSUMING DRUGS OR ALCOHOL**





Collisions result in more **INJURIES AND DEATHS** than any other type of accident for personal watercraft (PWC).  
**TO AVOID COLLISIONS:**  
SCAN CONSTANTLY for people, objects, and other watercraft. Be alert for conditions that limit your visibility or block your vision of others.  
**OPERATE DEFENSIVELY** at safe speeds and keep a safe distance away from people, objects, and other watercraft.

- Do not follow directly behind PWCs or other boats.
- Do not go near others to spray or splash them with water.
- Avoid sharp turns or other maneuvers that make it hard for others to avoid you or understand where you are going.
- Avoid areas with submerged objects or shallow water.

**DO NOT RELEASE THROTTLE WHEN TRYING TO STEER** away from objects – you need throttle to steer.  
Always check throttle and steering controls for proper operation before starting PWC.  
Follow navigation rules and state/province and local laws that apply to PWCs.  
See Owner's Manual for more information.

READ AND FOLLOW OWNER'S MANUAL  
YAMAHA

F1W-U41B1-10



4

# General and important labels

2

## ⚠ AVERTISSEMENT

Afin de limiter les risques de BLESSURES GRAVES, voire MORTELLES: PORTER UN GILET DE SAUVETAGE. Tout utilisateur doit porter un gilet de sauvetage homologué pour les scooters des mers. PORTER DES VÊTEMENTS PROTÉCTEURS. Le choc infligé par la pénétration forcée d'eau dans les orifices corporels lors d'une chute ou lors du contact avec le jet d'eau de la pompe risque de provoquer des lésions graves. Le port d'un simple maillot de bain ne constitue pas une protection adéquate contre la puissance de pénétration de l'eau dans le rectum et/ou le vagin. Tout utilisateur doit porter le pantalon d'une tenue de plongée ou tout autre vêtement offrant une protection semblable. (Voir le manuel d'utilisation.) Le port de chaussures, de gants et de lunettes de plongée est recommandé. CONNAÎTRE LES LOIS DE NAVIGATION. La Yamaha Motor Co., Ltd. recommande la limite d'âge de pilotage de 16 ans. Vérifier l'âge du pilote ainsi que les exigences quant à l'âge prévues par la législation locale. Il est préférable, et parfois requis par certaines législations, de suivre un cours de sécurité maritime. ATTACHER LA LANIÈRE DE L'INTERRUPTEUR D'ARRÊT DU MOTEUR au poignet et l'éloigner du guidon afin que le moteur se coupe bien en cas de chute. Après utilisation, retirer la lanière du scooter afin de prévenir toute utilisation par des enfants ou des personnes non-autorisées.



YAMAHA

F1B-U41B1-21

3

## ⚠ AVERTISSEMENT

Afin de limiter les risques de BLESSURES GRAVES, voire MORTELLES:

RESPECTER SES LIMITES ET ÉVITER LES MANŒUVRES BRUTALES afin de limiter tout risque de perte de contrôle, d'éjection et de collision. Il s'agit d'un véhicule à hautes performances et pas d'un jouet. Des virées brusques ou le saut de sillages ou de vagues accroît le risque de blessures au dos, voire de paralysie, de blessures au visage et de fractures diverses. **Ne jamais sauter des sillages ni des vagues.**

NE PAS DONNER DES GAZ LORSQUE QUELQU'UN SE TROUVE DERRIÈRE LE VÉHICULE: couper le moteur ou laisser tourner au ralenti. Eau et/ou débris projetés par la pompe pourraient causer des blessures graves. NE PAS S'APPROCHER DE LA GRILLE D'ADMISSION lorsque le moteur tourne. Cheveux longs, vêtements amples ou lanières de gilet de sauvetage risquent d'être happés, ce qui pourrait provoquer des blessures, ou même une noyade.

NE JAMAIS PILOTER APRÈS AVOIR ABSORBÉ DE L'ALCOOL, DES DROGUES OU CERTAINS MÉDICAMENTS.

LIRE ET RESPECTER LES INSTRUCTIONS DONNÉES DANS LE MANUEL D'UTILISATION.

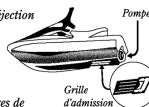

YAMAHA

F1B-U41B1-31

4

## ⚠ AVERTISSEMENT

Les collisions sont la cause principale des BLESSURES ET DÉCÈS

d'utilisateurs de scooter des mers. POUR ÉVITER LES

COLLISIONS: ÊTRE CONSTAMMENT à l'affût de

personnes, d'objets et d'autres bateaux. Être conscient des

conditions limitant sa visibilité ou celle des autres embarcations.

PILOTER AVEC PRUDENCE à des vitesses raisonnables

et garder une distance de sécurité entre le scooter et toute personne, objet et embarcation.

• Ne pas suivre une autre embarcation de trop près.

• Ne pas se rapprocher d'autrui en vue de l'éclabousser

• Éviter les virages brusques ou toute manœuvre qui risque de mettre un autre pilote

en danger ou qui l'empêche de pouvoir déterminer clairement la direction que l'on prend.

• Éviter les endroits où flottent des objets et les eaux peu profondes.

RÉAGIR RAPIDEMENT en vue d'éviter les collisions. Garder à l'esprit que les

bateaux n'ont pas de freins.

NE PAS LÂCHER LES GAZ LORSQUE L'ON ESSAYE DE S'ÉLOIGNER

d'objets-une poussée est nécessaire à la direction du scooter des mers. Toujours

s'assurer avant le départ que l'accélérateur et la direction fonctionnent

correctement. Suivre les lois de navigation ainsi que les législations nationales,

provinciales et locales concernant les scooters des mers.

Voir le manuel d'utilisation pour plus

d'informations.

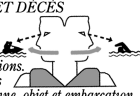

YAMAHA

F1B-U41B2-01

5

# General and important labels

5

<b>⚠ WARNING</b>	<b>⚠ AVERTISSEMENT</b>
<p>Gasoline is highly flammable and explosive. A fire or explosion could cause severe injury or death. Shut engine off. Refuel in well ventilated area away from flames or sparks. Do not smoke. Avoid spilling gasoline. Wipe up spilled gasoline immediately. Remove all seats to ventilate fuel vapors from engine compartment before starting engine. Do not start engine if there is a fuel leak or a loose electrical connection.</p>	<p><i>L'essence est très inflammable et explosible. Un incendie ou une explosion risque de provoquer des blessures graves, voire mortelles. Couper le moteur. Faire le plein dans un endroit bien aéré et éloigné de toute flamme ou étincelle. Ne pas fumer. Éviter de renverser de l'essence. Essayer immédiatement toute coulure d'essence. Déposer les selles pour évacuer les vapeurs d'essence du compartiment du moteur avant de mettre le moteur en marche. Ne jamais mettre le moteur en marche en cas de fuite d'essence ou si un branchement électrique est desserré.</i></p>
<b>REGULAR UNLEADED GASOLINE ONLY</b>	<b>ESSENCE NORMALE SANS PLOMB UNIQUEMENT</b>

F1S-U415B-11

6

<b>⚠ WARNING</b>
REVERSE SHIFT LEVER OPERATION:
<ul style="list-style-type: none"><li>• Shift only while engine is idling or off.</li><li>• Reverse is for low speed maneuvering only.</li><li>• Do not use reverse function to slow down or stop PWC as it could cause you to lose control, be ejected, or impact handlebars.</li><li>• Make sure that there are no obstacles or people behind you before shifting to reverse.</li></ul>
<b>⚠ AVERTISSEMENT</b>
FONCTIONNEMENT DU LEVIER D'INVERSION DE MARCHÉ:
<ul style="list-style-type: none"><li>• Inverser la marche uniquement lorsque le moteur tourne au ralenti ou lorsqu'il est coupé.</li><li>• La marche arrière est destinée exclusivement aux manœuvres à vitesse réduite.</li><li>• Ne pas sélectionner la marche arrière en vue de ralentir ou d'arrêter le scooter des mers, car il y a risque de perte de contrôle, d'éjection ou de heurt sur le guidon.</li><li>• S'assurer qu'il n'y a ni obstacle ni personne derrière le scooter avant d'engager la marche arrière.</li></ul>

F0V-U41D5-31

7

<b>⚠ WARNING</b>
<p>Do not use cleat or grips to lift PWC. PWC could fall, which could result in severe injury.</p>
<b>⚠ AVERTISSEMENT</b>
<p>Ne pas soulever le scooter à l'aide du taquet ou des poignées. Le scooter pourrait tomber et provoquer des blessures graves.</p>

(F1S-U41E1-11)

8

<b>⚠ WARNING</b>
<ul style="list-style-type: none"><li>• Severe internal injuries can occur if water is forced into body cavities as a result of being near jet thrust nozzle.</li><li>• Wear a wetsuit bottom or clothing that provides equivalent protection.</li><li>• Do not board PWC if operator is applying throttle.</li></ul>
<b>⚠ AVERTISSEMENT</b>
<ul style="list-style-type: none"><li>• Le choc infligé par la pénétration forcée d'eau dans les orifices corporels lors du contact avec le jet de la pompe risque de provoquer des lésions graves.</li><li>• Porter le pantalon d'une tenue de plongée ou tout autre vêtement offrant une protection semblable.</li><li>• Ne pas embarquer lorsque la pilote donne des gaz.</li></ul>

(F1S-U41E1-11)

# General and important labels

9

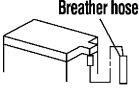
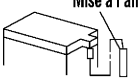
<b>⚠ WARNING</b>	
Be sure to connect breather hose to battery. Fire or explosion could result if not connected properly.	
<b>⚠ AVERTISSEMENT</b>	
Bien veiller à brancher la durit de mise à l'air à la batterie. Un mauvais branchement risque d'être à l'origine d'un incendie ou d'une explosion.	
<b>YAMAHA</b>	

F0V-U41DB-12

10

<b>⚠ WARNING / AVERTISSEMENT / 警告</b>	
<b>Do not touch or remove electrical parts when starting or running the engine.</b>	
<b>Ne pas toucher ou retirer les pièces électriques lors du démarrage ou de la marche du moteur.</b>	
<b>運転中は電装品には触らないでください。</b>	
<b>YAMAHA</b>	<b>6B6-63623-00</b>

11

<b>⚠ AVERTISSEMENT</b>	
<b>APPLICABLE POUR LA FRANCE SEULEMENT</b>	
<ul style="list-style-type: none"><li>• <i>En France : permis de conduire et immatriculation obligatoire.</i></li><li>• <i>Navigation en mer autorisée entre 300 mètres et 2 milles nautique.</i></li><li>• <i>Entre 0 et 300 mètres, se référer aux instructions nautiques locales affichées. Sinon, règle générale : vitesse maxi 5 noeuds (9Km/h) dans cette zone.</i></li><li>• <i>Utiliser les chenaux obligatoires de sortie lorsqu'ils existent.</i></li><li>• <i>Respecter les règles de priorité.</i></li><li>• <i>Gilet de sauvetage obligatoire-Fusée et bout de remorquage à bord.</i></li><li>• <i>Ne jamais conduire sous l'influence de l'alcool ou de drogues.</i></li><li>• <i>Consulter la météo avant de sortir en mer.</i></li><li>• <i>Une conduite responsable et un contrôle quotidien de votre machine suivant le manuel d'entretien YAMAHA seront garants de votre sécurité.</i></li></ul>	
<b>YAMAHA</b>	<b>GPB-U416H-01</b>

# General and important labels

EJU36261

## Other labels

12

**FIRE EXTINGUISHER CONTAINER  
COMPARTIMENT DE L'EXTINCTEUR**

F1B-U41F5-21

13

**RATED PERSON CAPACITY: 3  
MAXIMUM LOAD: 240 kg (530 lb)  
CAPACITÉ MAXIMALE: 3 personnes  
CHARGE MAXIMALE: 240 kg(530 lb)**

(F1S-U41E1-11)

14



The following label indicates the correct direction to upright a capsized watercraft.

15

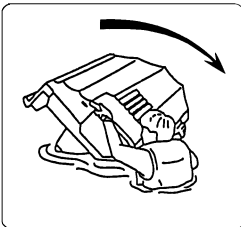

F1G-U41B-00

# General and important labels

---

The following CE marking is located on the back of the remote control transmitter.

16

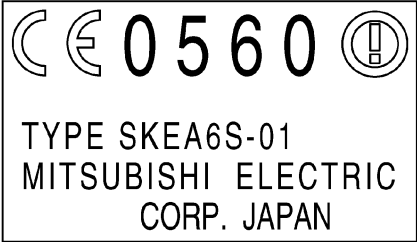



EJU30682

The safe use and operation of this watercraft is dependent upon the use of proper riding techniques, as well as upon the common sense, good judgment, and expertise of the operator. Before using this watercraft, make sure that its use is permitted under local laws, bylaws, and regulations, and always operate the watercraft in full conformity with any requirements and limitations imposed. Every operator should know the following requirements before riding the watercraft.

- Before operating the watercraft, read this owner's/operator's manual, the Riding Practice Guide, the Riding Instruction card, and all labels on the watercraft. These materials should give you an understanding of the watercraft and its operation.
- Never allow anyone to operate this watercraft until they too have read this owner's/operator's manual, the Riding Practice Guide, the Riding Instruction card, and all labels.

EJU30740

## Limitations on who may operate the watercraft

- Yamaha recommends a minimum operator age of 16 years old. Adults must supervise use by minors. Know your local operator age and training requirements.
- This watercraft is designed to carry the operator and up to 2 passengers. Never exceed the maximum load limit or allow more than 3 persons (or 2 persons if a water-skier is being pulled) to ride the watercraft at any time.



Maximum load:  
240 kg (530 lb)  
Load is the total weight of cargo, operator, and passengers.

- Do not operate the watercraft with any passengers on board until you have considerable practice and experience riding alone. Operating the watercraft with passengers requires more skill. Take the time to become accustomed to the handling characteristics of the watercraft before trying any difficult maneuvers.

# Safety information

EJU30761

## Cruising limitations

- Scan constantly for people, objects, and other watercraft. Be alert for conditions that limit your visibility or block your vision of others.

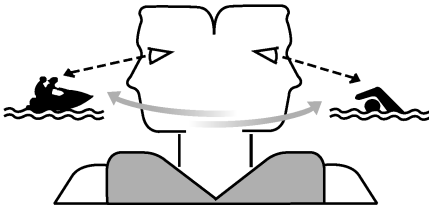

- Operate defensively at safe speeds and keep a safe distance away from people, objects, and other watercraft.
- Do not follow directly behind watercraft or other boats.
- Do not go near others to spray or splash them with water.
- Avoid sharp turns or other maneuvers that make it hard for others to avoid you or understand where you are going.
- Avoid areas with submerged objects or shallow water.
- Take early action to avoid collisions. Remember, watercraft and other boats do not have brakes.
- Do not release the throttle lever when trying to steer away from objects—you need throttle to steer. Always check throttle and steering controls before starting the watercraft.
- Ride within your limits and avoid aggressive maneuvers to reduce the risk of loss of control, ejection, and collision.
- This is a high performance boat—not a toy. Sharp turns or jumping wakes or waves can increase the risk of back/spinal injury (paralysis), facial injuries, and broken legs, an-

cles, and other bones. Do not jump wakes or waves.

- Do not operate the watercraft in rough water, bad weather, or when visibility is poor; this may lead to an accident causing injury or death. Be alert to the possibility of adverse weather. Take note of weather forecasts and the prevailing weather conditions before setting out on your watercraft.
- As with any water sport, you should not operate your watercraft without someone else nearby. If you operate further than swimming distance from shore, you should be accompanied by another boat or watercraft, but make sure you stay a safe distance away. It's good, common sense.
- Never operate in water that is less than 60 cm (2 ft) deep from the bottom of the watercraft, otherwise you increase your chance of hitting a submerged object, which could result in injury.

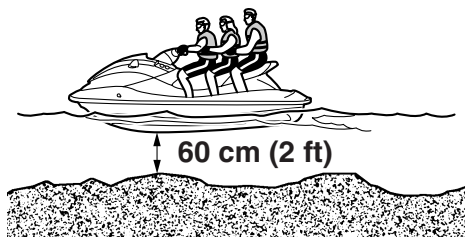

- This watercraft is not equipped with lighting required for night operation. Do not operate the watercraft after sunset or before dawn, otherwise you increase the risk of colliding

with another boat, which could result in severe injury or death.



- Follow navigation rules, and state/provincial and local laws that apply to watercraft.

EJU30821

## Operation requirements

- All riders must wear a personal flotation device (PFD) that is approved by the appropriate authorities and is suitable for personal watercraft use.
- Wear protective clothing. Severe internal injuries can occur if water is forced into body cavities as a result of falling into the water or being near the jet thrust nozzle. Normal swimwear does not adequately protect against forceful water entry into the rectum or vagina. All riders must wear a wetsuit bottom or clothing that provides equivalent protection. Such clothing includes thick, tightly woven, sturdy and snug-fitting apparel such as denim, but does not include spandex or similar fabrics, like those used in bicycle shorts.

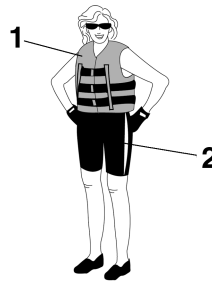

- 1 Authority-approved PFD
- 2 Wetsuit bottom

- Eye protection is recommended to keep wind, water, and glare from the sun out of your eyes while you operate your watercraft. Restraining straps for eyewear are made which are designed to float should your eyewear fall in the water. Footwear and gloves are recommended.
- You must decide whether to wear a helmet while you ride for recreation. You should know that a helmet could help protect you in

## Safety information

---

certain kinds of accidents and that it could injure you in others.

A helmet is designed to provide some head protection. Although helmets cannot protect against all foreseeable impacts, a helmet might reduce your injuries in a collision with a boat or other obstacle.

A helmet may have potential safety hazards, as well. Falling into the water could risk the chance of the helmet catching water, commonly known as “bucketing”, and the resulting strain on your neck could cause choking, severe and permanent neck injuries, or death. A helmet could also increase the risk of an accident if it reduces your vision or hearing, or if it distracts you or increases your fatigue.

How should you decide if a helmet’s potential safety benefits outweigh its potential risks for you? Consider your particular riding conditions. Consider factors such as your riding environment and your riding style and ability. Also consider the likelihood of traffic congestion, and the water surface conditions.

If you decide to wear a helmet based upon your riding circumstances, choose one carefully. Look for a helmet designed for personal watercraft use, if possible. If you will be engaging in closed-course competition, follow the helmet requirements of the sanctioning organization.

- Never operate the watercraft after consuming alcohol or taking other drugs.
- For reasons of safety and proper care of the watercraft, always perform the pre-operation checks listed on page 61 before operating the watercraft.
- The operator and passengers should always keep their feet on the floor of the footwell when the watercraft is in motion. Lifting

your feet increases the chances of losing your balance, or hitting objects outside the watercraft with your feet. Do not give a ride to children if their feet cannot reach the floor of the footwell.

- The passengers should hold on firmly, either to the person in front of them or to the handgrip provided.



- Never allow a passenger to ride in front of the operator.
- Always consult your doctor on whether it is safe for you to ride this watercraft if you are pregnant or in poor health.
- Do not attempt to modify this watercraft. Modifications to your watercraft may reduce safety and reliability, and render the watercraft unsafe or illegal for use.
- Attach the engine shut-off cord (lanyard) to your left wrist and keep it free from the handlebars so that the engine stops if you, the operator, fall off. After riding, remove the engine shut-off cord (lanyard) from the wa-

tercraft to avoid accidental starting or unauthorized use by children or others.

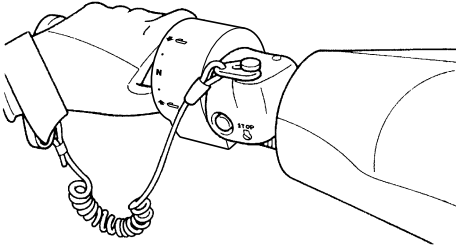

- Scan carefully for swimmers and stay away from swimming areas. Swimmers are hard to see and you could accidentally hit someone in the water.
- Avoid being hit by another boat. You should always take the responsibility to watch for traffic; other boaters may not be watching for you. If they do not see you, or if you maneuver more quickly than other boaters expect, you risk a collision.
- Maintain a safe distance from other boats and watercraft, and also watch for ski ropes or fishing lines. Obey the “Safe boating rules” and be sure to check behind you before making a turn. (See “Safe boating rules” on page 19.)

EJU30840

## Recommended equipment

The following items should be carried on board your watercraft:

- Sound-signaling device  
You should carry a whistle or other sound-signaling device that can be used to signal other boats.
- Visual distress signals  
It is recommended that a pyrotechnic device, which is approved by the appropriate authorities, be stored in a waterproof container on your watercraft. A mirror can also be used as an emergency signal. Contact a Yamaha dealer for more information.
- Watch  
A watch is helpful so you will know how long you have been operating the watercraft.
- Towline  
A towline can be used to tow a disabled watercraft in an emergency.

# Safety information

---

EJU36850

## Hazard information

- Never start the engine or let it run for any length of time in an enclosed area. Exhaust fumes contain carbon monoxide, a colorless, odorless gas that may cause loss of consciousness and death within a short time. Always operate the watercraft in an open area.
- Do not touch the hot muffler or engine during or immediately after engine operation; they can cause serious burns.

EJU30920

## Watercraft characteristics

- Jet thrust turns the watercraft. Releasing the throttle lever completely produces only minimum thrust. If you are traveling at speeds above trolling, you will have rapidly decreasing ability to steer without throttle. This model is equipped with the Yamaha Engine Management System (YEMS) that includes an off-throttle steering (OTS) system. It will activate at planing speeds should you attempt to steer the watercraft after releasing the throttle lever. The OTS system assists in turning by continuing to supply some thrust while the watercraft is decelerating, but you can turn more sharply if you apply throttle while turning the handlebars. The OTS system does not function below planing speeds or when the engine is off. Once the engine slows down, the watercraft will no longer turn in response to handlebar input until you apply throttle again or you reach trolling speed. Practice turning in an open area without obstacles until you have a good feel for this maneuver.
- This watercraft is water-jet propelled. The jet pump is directly connected to the engine. This means that jet thrust will produce some movement whenever the engine is running. There is no “neutral” position. You are in either “forward” or “reverse”, depending upon the shift lever position.
- Do not use the reverse function to slow down or stop the watercraft as it could cause you to lose control, be ejected, or impact the handlebars. This could increase the risk of back/spinal injury (paralysis), facial injuries, and broken legs, ankles, and other bones. You could also damage the shift mechanism.

## Safety information

- Reverse can be used to slow down or stop during slow-speed maneuvering, such as when docking. Once the engine is idling, shift into reverse and gradually increase engine speed. Make sure that there are no obstacles or people behind you before shifting into reverse.
- Keep away from the intake grate while the engine is on. Items such as long hair, loose clothing, or PFD straps can become entangled in moving parts, resulting in severe injury or drowning.
- Never insert any object into the jet thrust nozzle while the engine is running. Severe injury or death could result from coming in contact with the rotating parts of the jet pump.

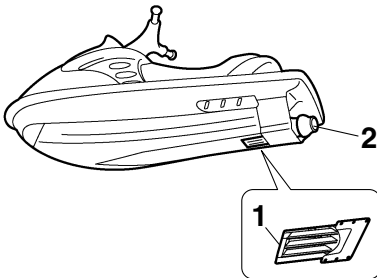

- 1 Intake grate
- 2 Jet thrust nozzle

- Stop the engine and remove the clip from the engine shut-off switch before removing

any debris or weeds, which may have collected around the jet intake.

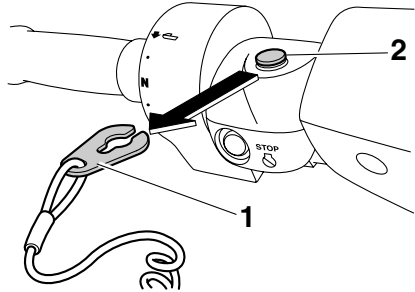

- 1 Clip
- 2 Engine shut-off switch

# Safety information

EJU30953

## Water-skiing

You can use the watercraft for water-skiing if it has the seating capacity to carry the operator, a rearward-facing spotter, and the water-skier when he or she is not skiing.

The watercraft must also have a cleat designed to pull a ski rope; do not attach the rope to any other location.

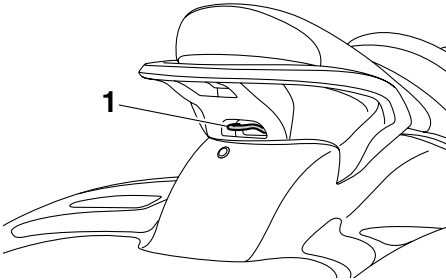

1 Cleat

It is the watercraft operator's responsibility to be alert to the safety of the water-skier and others. Know and follow all local water-skiing regulations in effect for the waters in which you will be operating.

The operator should be comfortable carrying passengers before attempting to pull a skier.

The following are some important considerations for minimizing risks while water-skiing.

- The skier should wear an approved PFD, preferably a brightly colored one so boat operators can see the skier.
- The skier should wear protective clothing. Severe internal injuries can occur if water is forced into body cavities as a result of falling into the water. Normal swimwear does not adequately protect against forceful water entry into the rectum or vagina. The skier should wear a wetsuit bottom or clothing that provides equivalent protection.
- A second person should be on board as a spotter to watch the skier; in many places it

is required by law. Let the skier direct the operator's control of speed and direction with hand signals.

The spotter should sit astride the rear of the seat and hold onto the handgrip with both feet firmly on the floor of the footwell for proper balance while facing to the rear to



watch the skier's hand signals and condition.

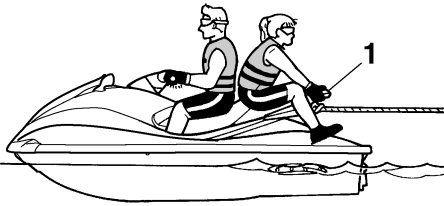

1 Handgrip

## FX SHO

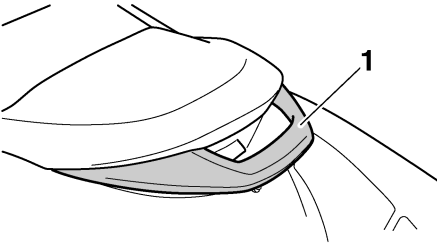

1 Handgrip

## FX Cruiser SHO

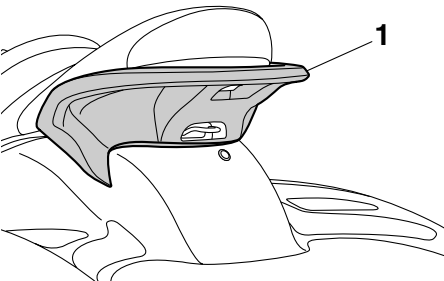

1 Handgrip

- Your control while pulling a water-skier is affected by the skier's ability, as well as water and weather conditions.
- When preparing to pull a skier, operate the watercraft at the slowest possible speed

until the watercraft is well away from the skier and slack in the ski rope is taken up. Make sure that the rope is not looped around anything.

After checking that the skier is ready and that there is no traffic or other obstacles, apply enough throttle to raise the skier.

- Make smooth, wide turns. The watercraft is capable of very sharp turns, which could exceed the abilities of the skier. Keep the skier at least 50 m (150 ft), about twice the distance of a standard ski rope, from any potential hazard.
- Be alert to the hazard of the ski rope handle snapping back at the watercraft when the skier falls or is unable to get up on the skis.
- Towing heavy or bulky objects other than skiers, such as another boat or watercraft, can cause loss of steering control and create a hazardous condition. If you must tow another boat in an emergency situation, operate slowly and cautiously.

# Safety information

---

EJU30970

## Safe boating rules

Your Yamaha watercraft is legally considered a powerboat. Operation of the watercraft must be in accordance with the rules and regulations governing the waterway on which it is used.

EJU30991

## Enjoy your watercraft responsibly

You share the areas you enjoy when riding your watercraft with others and with nature. So your enjoyment includes a responsibility to treat these other people, and the lands, waters, and wildlife with respect and courtesy. Whenever and wherever you ride, think of yourself as the guest of those around you. Remember, for example, that the sound of your watercraft may be music to you, but it could be just noise to others. And the exciting splash of your wake can make waves others won't enjoy.

Avoid riding close to shoreline homes and waterfowl nesting areas or other wildlife areas, and keep a respectful distance from fishermen, other boats, swimmers, and populated beaches. When travel in areas like these is unavoidable, ride slowly and obey all laws.

Proper maintenance is necessary to ensure that the exhaust emission and sound levels of your watercraft will continue to be within regulated limits. You have the responsibility to make sure that the recommended maintenance in this owner's/operator's manual is carried out.

Remember, pollution can be harmful to the environment. Do not refuel or add oil where a spill could cause damage to nature. Remove your watercraft from the water and move it away from the shoreline before refueling. Dispose of water and any fuel and oil residue in the engine compartment according to local regulations. And keep your surroundings pleasant for the people and wildlife that share the waterways: don't litter.

When you ride responsibly, with respect and courtesy for others, you help ensure that our

## **Safety information**

---

waterways stay open for the enjoyment of a variety of recreational opportunities.

# Description

---

EJU40302

## Watercraft glossary

### **Trolling speed**

“Trolling” is the lowest maneuvering speed. You are applying little or no throttle. The watercraft is down in the water, and there is no wake.

### **Sub-planing speed**

“Sub-planing” is a medium speed. The bow of the watercraft is slightly up from the water surface, but you are still traveling through the water. There is a wake.

### **Planing speed**

“Planing” is a faster speed. The watercraft is more level and is skimming on top of the water. There is a wake.

### **Bow**

The front end of the watercraft.

### **Stern**

The rear end of the watercraft.

### **Starboard**

The right side of the watercraft when facing forward.

### **Port**

The left side of the watercraft when facing forward.

### **Bilge water**

Water that has collected in the engine compartment.

### **Yamaha Engine Management System (YEMS)**

YEMS is an integrated, computerized management system that controls and adjusts ignition timing, fuel injection, engine diagnostics, and the off-throttle steering (OTS) system.

EJU31011

## Location of main components

### Exterior

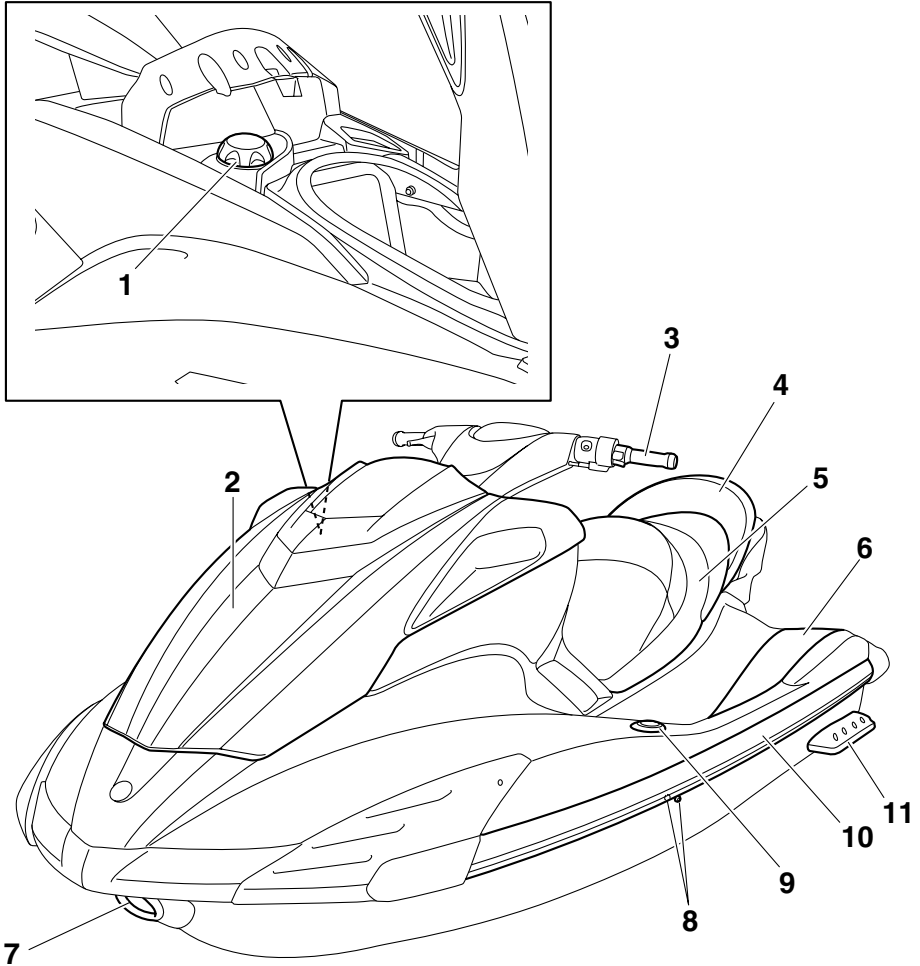

1 Fuel filler cap (page 54)

2 Hood

3 Handlebars

4 Rear seat (page 47)

5 Front seat (page 47)

6 Footwell

7 Bow eye (page 49)

8 Cooling water pilot outlet (page 30)

9 Pull-up cleat (FX Cruiser SHO) (page 50)

10 Gunwale

11 Sponson

# Description

---

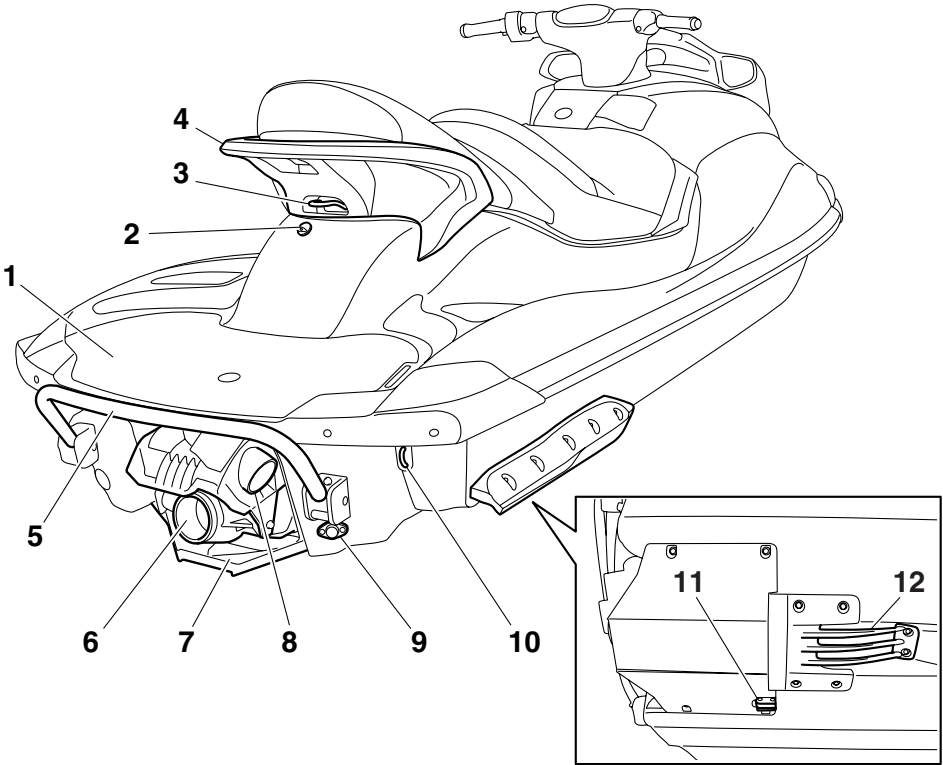

- 1 Boarding platform
- 2 Electric bilge pilot outlet
- 3 Cleat (page 49)
- 4 Handgrip (page 48)
- 5 Reboarding step (page 48)
- 6 Jet thrust nozzle
- 7 Ride plate
- 8 Reverse gate (page 32)
- 9 Stern drain plug (page 57)
- 10 Stern eye (page 49)
- 11 Speed sensor
- 12 Intake grate

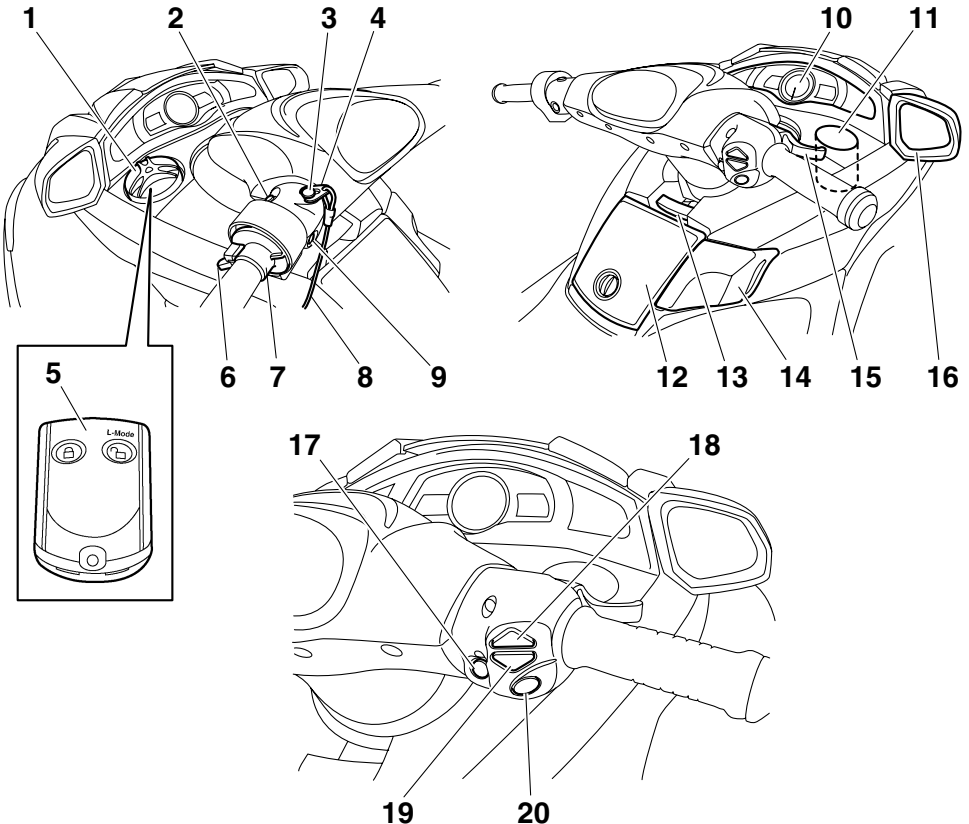

- 1 Watertight storage compartment (page 53)
- 2 Start switch (page 28)
- 3 Engine shut-off switch (page 28)
- 4 Clip (page 28)
- 5 Remote control transmitter (page 26)
- 6 Q.S.T.S. selector lock lever (page 33)
- 7 Q.S.T.S. selector (page 33)
- 8 Engine shut-off cord (lanyard) (page 28)
- 9 Engine stop switch (page 28)
- 10 Multifunction information center (page 39)
- 11 Beverage holder (page 53)
- 12 Glove compartment (page 51)
- 13 Tilt lever (page 30)
- 14 Shift lever (page 32)
- 15 Throttle lever (page 29)
- 16 Rearview mirror
- 17 "NO-WAKE MODE" switch (page 35)
- 18 Up switch (page 36)
- 19 Down switch (page 36)
- 20 "SET" switch (page 36)

# Description

---

## Engine compartment

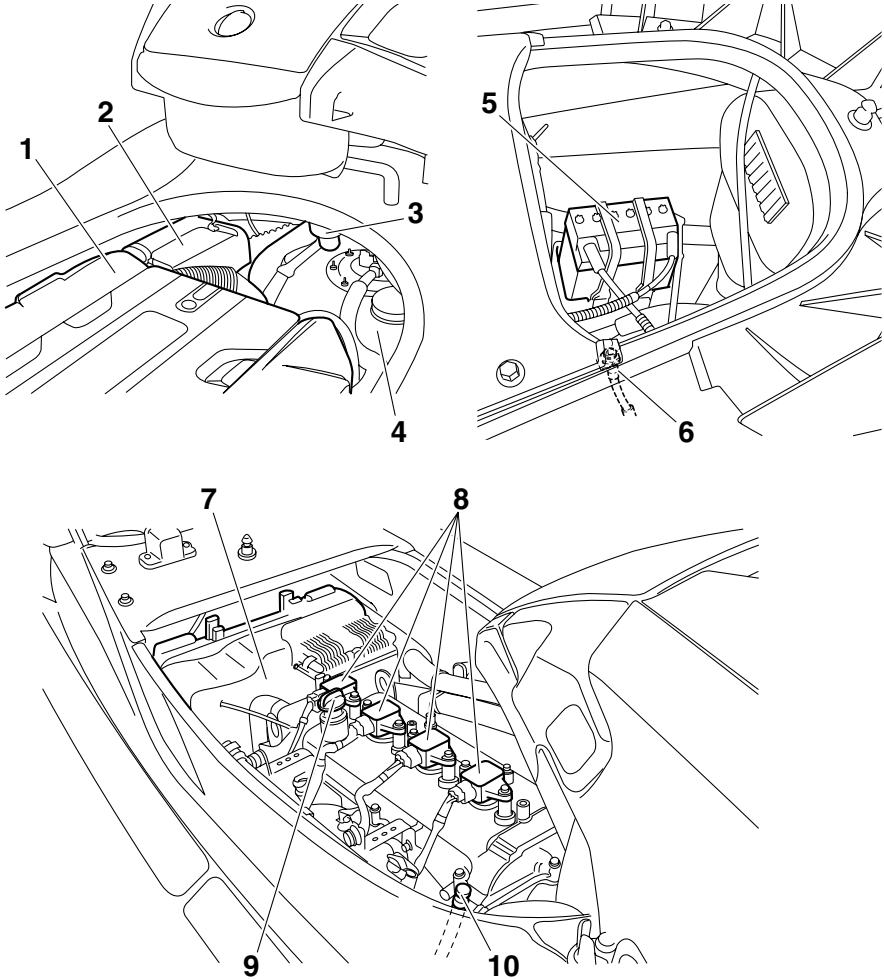

- 1 Engine cover
- 2 Air filter case
- 3 Water separator (page 31)
- 4 Fuel tank
- 5 Battery (page 64)
- 6 Flushing hose connector
- 7 Electrical box
- 8 Spark plug/Spark plug cap/Ignition coil
- 9 Engine oil filler cap (page 56)
- 10 Dipstick (page 56)



# Control function operation

EJU31024

## Watercraft control functions

EJU37126

### Remote control transmitter

The Yamaha Security System and Low RPM Mode settings can be selected by operating the remote control transmitter. (See page 27 for Yamaha Security System setting procedures and page 34 for Low RPM Mode activation procedures.)

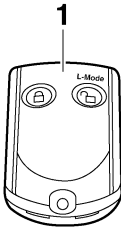

1 Remote control transmitter

Since the watercraft is programmed to recognize the internal code from this transmitter only, the settings can only be selected with this transmitter.

If you accidentally lose your remote control transmitter or if it is not operating properly, contact a Yamaha dealer.

When operating the watercraft, always keep the transmitter with you, such as by storing it

in the transmitter holder in the watertight storage compartment, so that it is not lost.

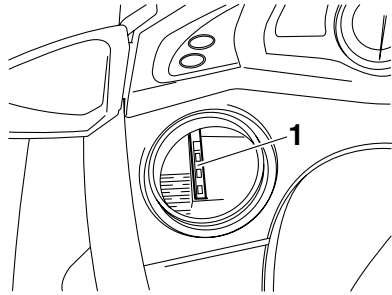

1 Transmitter holder

ECJ00752

### NOTICE

- The remote control transmitter is not completely waterproof. Do not submerge the transmitter or operate it underwater. If the transmitter is submerged, dry it with a soft, dry cloth, and then check that it is operating properly. If the transmitter is not operating properly, contact a Yamaha dealer.
- Keep the remote control transmitter away from high temperatures and do not place it in direct sunlight.
- Do not drop the remote control transmitter, subject it to strong shocks, or place any heavy items on it.
- Use a soft, dry cloth to clean the remote control transmitter. Do not use detergent, alcohol, or other chemicals.
- Do not attempt to disassemble the remote control transmitter yourself. Otherwise, the transmitter may not operate properly. If the transmitter needs a new battery, contact a Yamaha dealer. Refer to local hazardous waste regulations when disposing of transmitter batteries.

# Control function operation

EJU31384

## Yamaha Security System

The Yamaha Security System functions to help prevent unauthorized use or theft of the watercraft. The lock and unlock modes of the security system can be selected by operating the remote control transmitter that is included with this watercraft. The engine cannot be started if the lock mode of the security system is selected. The engine can only be started if the unlock mode is selected. (See page 26 for information on the remote control transmitter.)



### TIP:

The Yamaha Security System settings can only be selected while the engine is stopped.

EJU36775

## Yamaha Security System settings

The Yamaha Security System settings will be confirmed by the number of beeps when the remote control transmitter is operated, and by the “UNLOCK” indicator light of the multifunction information center. (See page 39 for information on the multifunction information center.)

Number of beeps	Yamaha Security System mode	“UN-LOCK” indicator light
	Lock	Goes off
	Unlock (normal operation mode)	Comes on
	Unlock (Low RPM Mode)	Comes on

### TIP:

- The beeper sounds two times for the normal operation mode or three times for the Low RPM Mode. (See page 34 for Low RPM Mode activation procedures.)
- If the remote control transmitter is operated while the multifunction information center is in the standby state, the center will perform

the initial operation, and then the setting is selected.

### To select the lock mode:

Push the lock button on the remote control transmitter briefly. The beeper sounds once and the “UNLOCK” indicator light blinks once, then goes off. This indicates the lock mode is selected.

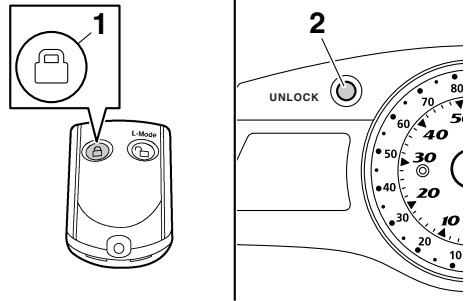

- 1 Lock button
- 2 “UNLOCK” indicator light

### To select the unlock mode:

Push the “L-Mode” (unlock) button on the remote control transmitter briefly. The beeper sounds two or three times and the “UNLOCK” indicator light blinks two or three times, then comes on. This indicates the unlock mode is selected.

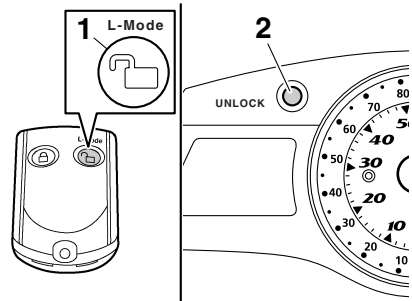

- 1 “L-Mode” (unlock) button
- 2 “UNLOCK” indicator light

# Control function operation

EJU31152

## Engine stop switch “”

The engine stop switch (red button) stops the engine when the switch is pushed.

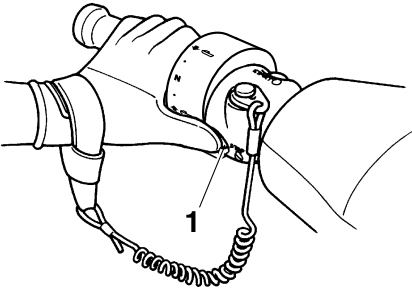

1 Engine stop switch

EJU31163

## Engine shut-off switch “”

The engine shut-off switch automatically stops the engine when the clip, on the end of the engine shut-off cord (lanyard), is removed from the switch, such as if the operator falls off the watercraft.

Insert the clip under the engine shut-off switch before starting the engine.

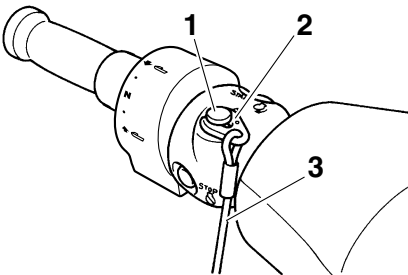

- 1 Engine shut-off switch
- 2 Clip
- 3 Engine shut-off cord (lanyard)

When the engine is not running, remove the clip from the engine shut-off switch to prevent

accidental starting or unauthorized operation by children or others.

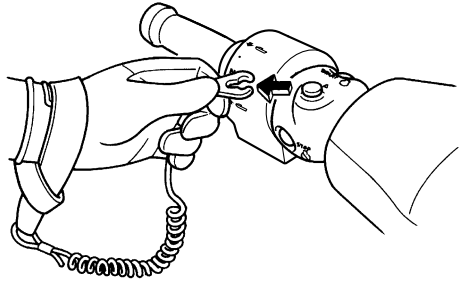

EJU36284

## Start switch “”

ECJ01310

### **NOTICE**

**Do not run the engine over 4000 r/min on land. Also, do not run the engine for more than 15 seconds without supplying water, otherwise the engine could overheat.**

The start switch (green button) starts the engine when the switch is pushed.

Release the start switch as soon as the engine starts to run. If the engine does not start in 5 seconds, release the start switch, wait 15 seconds, and then try again. **NOTICE: Never push the start switch while the engine is running. Do not operate the start switch for more than 5 seconds, otherwise the battery will be discharged and the engine**

# Control function operation

will not start. Also, the starter motor could be damaged. [ECJ01040]

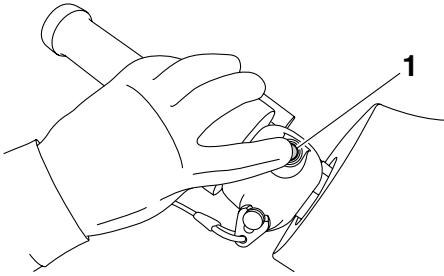

1 Start switch

The engine will not start under any of the following conditions:

- Lock mode of the Yamaha Security System has been selected. (See page 27 for Yamaha Security System setting procedures.)
- Clip is removed from the engine shut-off switch.
- Throttle lever is squeezed.

EJU31211

## Throttle lever

The throttle lever increases the engine speed when the lever is squeezed.

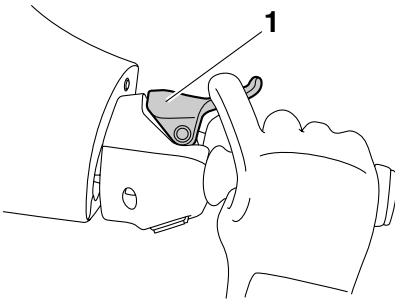

1 Throttle lever

The throttle lever returns automatically to its fully closed (idle) position when released.

EJU31261

## Steering system

By turning the handlebars in the direction you wish to travel, the angle of the jet thrust nozzle is changed, and the direction of the watercraft is changed accordingly.

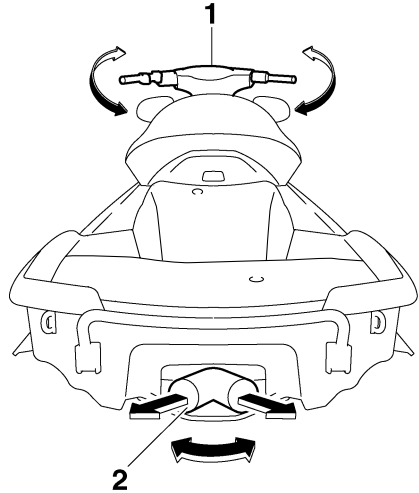

1 Handlebar

2 Jet thrust nozzle

Since the strength of the jet thrust determines the speed and degree of a turn, throttle must always be applied when attempting a turn, except at trolling speed.

This model is equipped with the Yamaha Engine Management System (YEMS) that includes an off-throttle steering (OTS) system. It will activate at planing speeds should you attempt to steer the watercraft after releasing the throttle lever. The OTS system assists in turning by continuing to supply some thrust while the watercraft is decelerating, but you can turn more sharply if you apply throttle while turning the handlebars. The OTS system does not function below planing speeds or when the engine is off. Once the engine slows down, the watercraft will no longer turn

# Control function operation

in response to handlebar input until you apply throttle again or you reach trolling speed.

EJU31293

## Adjustable tilt steering system

The position of the handlebars can be adjusted back and forth by operating the tilt lever.

To adjust the handlebar position:

- (1) Pull the tilt lever up to disengage the handlebar lock, and then move the handlebars back or forth to the desired position.

**WARNING! Never pull the tilt lever during operation, otherwise the handlebars may suddenly change position, which may lead to an accident.** [EJWJ00041]

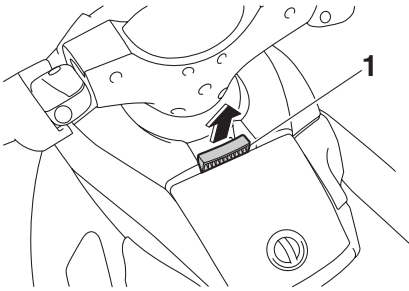

1 Tilt lever

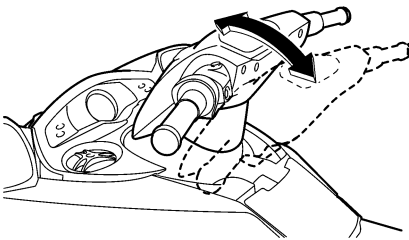

- (2) Make sure that the tilt lever returns to its original position and that the handlebars are securely locked in place.

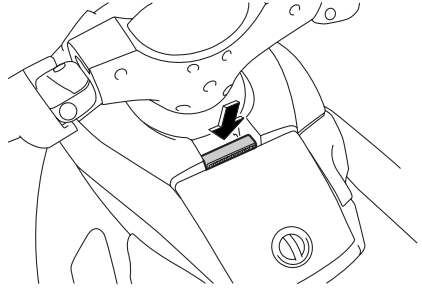

EJU36743

## Cooling water pilot outlets

When the engine is running, some of the cooling water that is circulated in the engine is discharged from the cooling water pilot outlets.

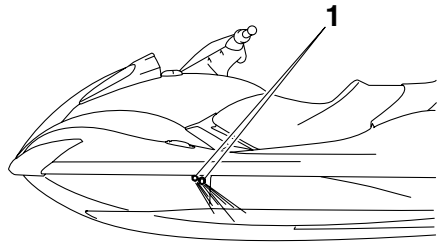

1 Cooling water pilot outlet (port [left] side)

There are cooling water pilot outlets on the port (left) and starboard (right) sides of the watercraft. To check for proper operation of the cooling system, make sure that water is being discharged from the port (left) pilot outlets. If water is not being discharged from these outlets, stop the engine and check the jet intake for clogging. (See page 97 for information on the jet intake.)

## TIP:

- It will take about 60 seconds for the water to reach the outlets after the engine is started.

# Control function operation

---

- Water discharge may not be constant when the engine is running at idling speed. If this occurs, apply a little throttle to make sure that water discharges properly.

EJU40322

## Water separator

The water separator prevents water from entering the fuel tank by collecting any water that has entered the fuel tank breather hose if the watercraft was capsized.

If water has collected in the water separator, drain it by loosening the drain screw.

watercraft, be sure to wipe it up with a dry cloth.

- (3) Securely tighten the drain screw until it stops.

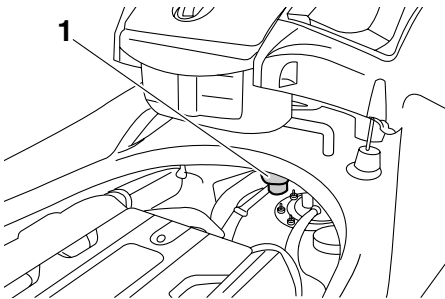

1 Water separator

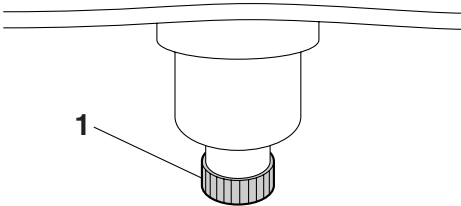

1 Drain screw

### To drain water from the water separator:

- (1) Place a drain pan or dry cloth under the water separator.
- (2) Gradually loosen the drain screw to drain the water. Catch the draining water in the drain pan or soak it up with the dry cloth so that it does not spill into the engine compartment. If any water spills into the

# Watercraft operation

EJU40011

## Watercraft operation functions

EJU37182

### Reverse system

EWJ01230

#### **WARNING**

- Do not use the reverse function to slow down or stop the watercraft as it could cause you to lose control, be ejected, or impact the handlebars.
- Make sure that there are no obstacles or people behind you before shifting into reverse.
- Do not touch the reverse gate while the shift lever is being operated, otherwise you could be pinched.

When the shift lever is moved to the reverse position, the reverse gate lowers and deflects the water jet being discharged from the jet thrust nozzle. This allows the watercraft to move in reverse.

#### To shift into reverse:

- (1) Release the throttle lever and let the engine speed return to idle.
- (2) Pull the shift lever rearward until it stops in the reverse position. The reverse gate

will lower and the watercraft will start moving in reverse at trolling speed.

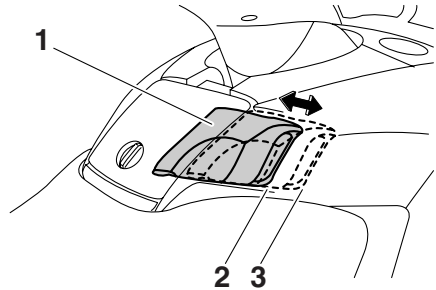

- 1 Shift lever
- 2 Reverse position
- 3 Forward position

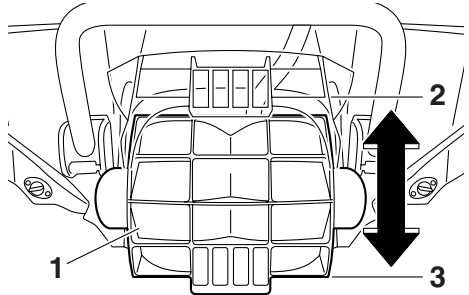

- 1 Reverse gate
- 2 Forward position
- 3 Reverse position

#### **TIP:**

This model is equipped with a function which limits the engine speed in reverse.

#### To shift into forward:

- (1) Release the throttle lever and let the engine speed return to idle.
- (2) Push the shift lever forward until it stops in the forward position. The reverse gate will rise and the watercraft will start moving forward at trolling speed.

# Watercraft operation

EJU31317

## Quick Shift Trim System (Q.S.T.S.)

The Q.S.T.S. selector is integrated with the left handlebar grip and is operated to change the vertical angle of the jet thrust nozzle, which adjusts the trim angle of the watercraft. There are 5 positions: neutral, 2 bow-down positions (a) and (b), and 2 bow-up positions (c) and (d).

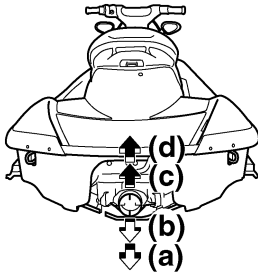
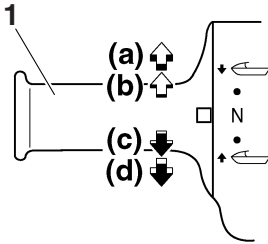

1 Q.S.T.S. selector

### Bow-down positions (a) and (b)

The bow will go down, causing the trim angle to decrease.

Vertical movement of the bow will be reduced and the watercraft will get up on plane more quickly when accelerating.

### Bow-up positions (c) and (d)

The bow will go up, causing the trim angle to increase.

There is less water resistance, therefore, straight-ahead acceleration is enhanced.

## TIP:

The watercraft performance characteristics according to the trim angle change depending on the operating conditions.

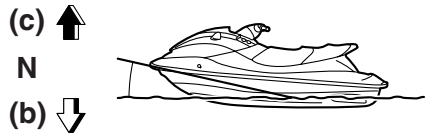

### To change the trim angle:

- (1) Reduce engine speed to less than 3000 r/min.
- (2) Squeeze the Q.S.T.S. selector lock lever, and then turn the Q.S.T.S. selector to the desired position. **NOTICE: Do not turn the Q.S.T.S. selector while operating the watercraft at an engine speed of**



# Watercraft operation

3000 r/min or more, otherwise damage could occur to the Q.S.T.S.\* [ECJ00013]

EJU40000

## Watercraft operation modes

EJU36784

### Low RPM Mode

When the Low RPM Mode is activated, maximum engine speed (r/min) is limited to approximately 70% of the maximum engine speed in the normal operation mode.

The Low RPM Mode can only be activated and deactivated by operating the remote control transmitter. (See page 26 for information on the remote control transmitter.)

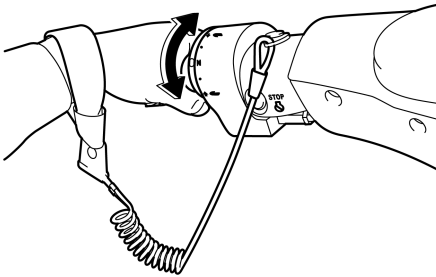
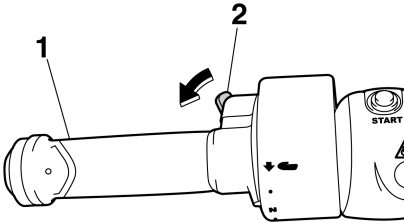

- 1 Q.S.T.S. selector
- 2 Q.S.T.S. selector lock lever

- (3) Release the lock lever, and then make sure that the Q.S.T.S. selector is securely locked in place.

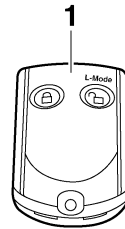

- 1 Remote control transmitter

### TIP:

The Low RPM Mode can only be activated when the engine is stopped in the unlock mode of the Yamaha Security System.

### Activating and deactivating the Low RPM Mode

Activation of the Low RPM Mode will be confirmed by the number of beeps when the remote control transmitter is operated, and by the “L-MODE” indicator light of the multifunction information center. (See page 39 for information on the multifunction information center.)

# Watercraft operation

Number of beeps	Low RPM Mode operation	“L-MODE” indicator light
● ● ●	Activated	Comes on
● ●	Deactivated	Goes off

## TIP:

If the remote control transmitter is operated while the multifunction information center is in the standby state, the center performs the initial operation, and then the setting is selected.

To activate the Low RPM Mode:

Push the “L-Mode” (unlock) button on the remote control transmitter for more than 4 seconds. Once the beeper sounds three times and the “UNLOCK” indicator light blinks three times, then comes on, the “L-MODE” indicator light comes on and the Low RPM Mode is activated.

## TIP:

If the Low RPM Mode is activated immediately after the information display turns off, the “L-MODE” indicator light will not come on. The “L-MODE” indicator light will come on when the engine is started.

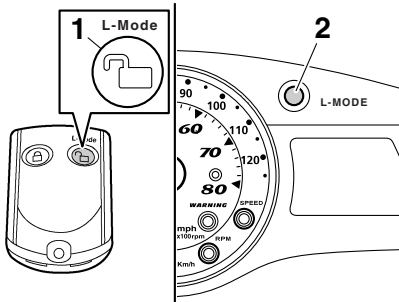

- 1 “L-Mode” (unlock) button
- 2 “L-MODE” indicator light

To deactivate the Low RPM Mode:

Push the “L-Mode” (unlock) button on the remote control transmitter for more than 4 sec-

onds. Once the beeper sounds two times and the “UNLOCK” indicator light blinks two times, then comes on, the “L-MODE” indicator light goes off and the Low RPM Mode is deactivated. When the Low RPM Mode is deactivated, the watercraft returns to the normal operation mode.

EJU37015

## No-wake mode

The no-wake mode is a function that maintains the engine speed at a fixed setting for operating the watercraft at low speeds. This function can be used only for forward operation of the watercraft.

## TIP:

The no-wake mode can only be activated after 5 seconds have elapsed since starting the engine.

## Activating and deactivating the no-wake mode

Activation of the no-wake mode will be confirmed by the number of beeps when the “NO-WAKE MODE” switch is pushed, and by the digital speedometer display of the multifunction information center. (See page 39 for information on the multifunction information center.)

Number of beeps	No-wake mode operation	Digital speedometer display
● ● ●	Activated	Starts blinking
● ●	Deactivated	Stops blinking

## TIP:

The beeps and the blinking digital speedometer display also indicate the activation of the cruise assist. (See page 36 for information on the cruise assist.)

# Watercraft operation

## To activate the no-wake mode:

- (1) Release the throttle lever and let the engine speed return to idle.
- (2) Make sure that the shift lever is in the forward position. The no-wake mode cannot be activated when the shift lever is in the reverse position.

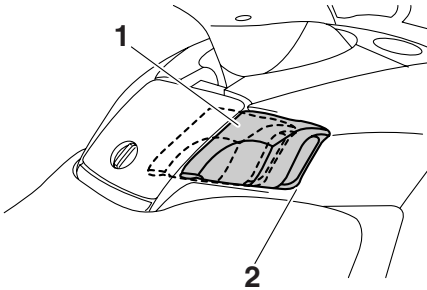

- 1 Shift lever  
2 Forward position

- (3) Push and hold the “NO-WAKE MODE” switch. Once the beeper sounds three times quickly and “8” (when kilometers are selected) or “5” (when miles are selected) starts blinking in the digital speedometer display, the no-wake mode is activated. Keep the throttle lever in the fully closed (idle) position when the no-wake mode is activated.

## **TIP:**

The digital speedometer display blinks continually while the no-wake mode is activated.

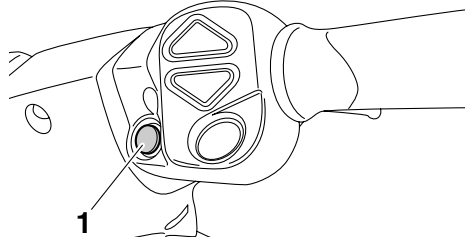

1 “NO-WAKE MODE” switch

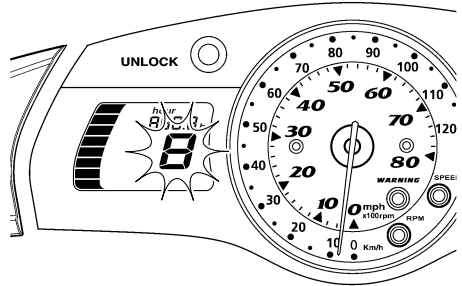

## To deactivate the no-wake mode:

Perform one of the following operations. The beeper sounds two times quickly and the digital speedometer display stops blinking when the no-wake mode is deactivated.

- Push the “NO-WAKE MODE” switch.
- Squeeze the throttle lever.

## **TIP:**

The no-wake mode is also deactivated when the engine is stopped.

EJU37025

## **Cruise assist**

The cruise assist is a function for maintaining a desired engine speed within a fixed range while operating the watercraft.

# Watercraft operation

---

## TIP:

- The cruise assist can only be set between engine speeds of approximately 3000 r/min and approximately 7000 r/min.
- The cruise assist cannot be activated in the Low RPM Mode. (See page 34 for Low RPM Mode activation procedures.)

## Activating and deactivating the cruise assist

Activation of the cruise assist will be confirmed by the number of beeps when the “SET” switch, up switch, or down switch is pushed, and by the digital speedometer display of the multifunction information center. (See page 39 for information on the multifunction information center.)

Number of beeps	Cruise assist operation	Digital speedometer display
● ● ●	Activated	Starts blinking
● ●	Deactivated	Stops blinking
●	Set engine speed increases or decreases	Continues blinking

## TIP:

The beeps and the blinking digital speedometer display also indicate the activation of the no-wake mode. (See page 35 for information on the no-wake mode.)

### To activate the cruise assist:

- (1) Operate the throttle lever until the desired engine speed is reached.
- (2) When the engine speed reaches the desired cruise assist setting, push the “SET” switch. Once the beeper sounds three times quickly and the digital speedometer display starts blinking, the cruise assist is activated. When the cruise assist is activated, slowly squeeze the throttle lever to keep it squeezed further than the position

at which the cruise assist was set; releasing the throttle lever will deactivate the cruise assist.

## TIP:

The digital speedometer display blinks continually while the cruise assist is activated. Make sure that the beeper has sounded and the digital speedometer display is blinking before squeezing the throttle lever to the full throttle position. If the speedometer display is not blinking, the cruise assist is not activated and

# Watercraft operation

the engine will respond normally to the throttle operation.

engine speed will change. However, the adjustment is limited to a maximum of five increments above or below the initial cruise assist setting.

To deactivate the cruise assist:

Relax your grip on the throttle lever. The beeper sounds two times quickly and the digital speedometer display stops blinking when the cruise assist is deactivated.

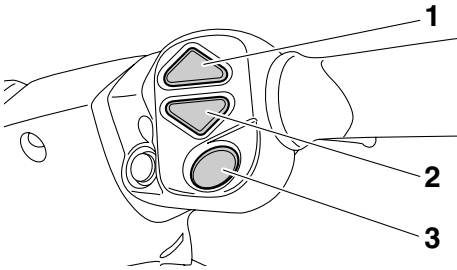

- 1 Up switch
- 2 Down switch
- 3 "SET" switch

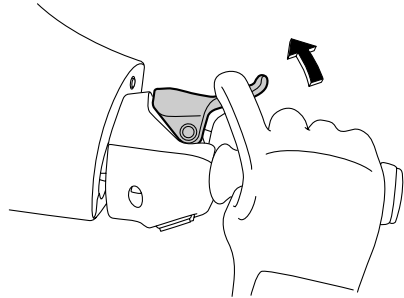

**TIP:**

The cruise assist is also deactivated when the engine is stopped.

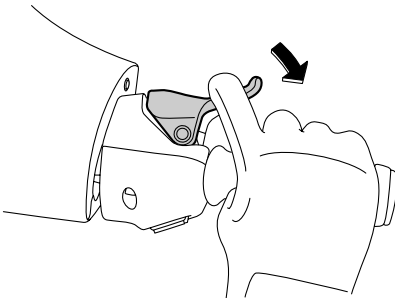
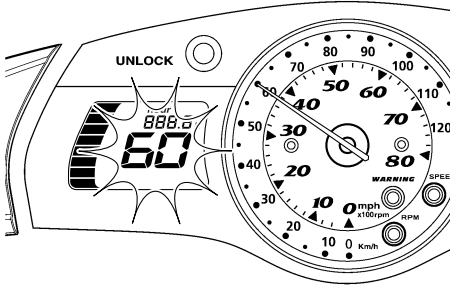

**TIP:**

Once the cruise assist is activated, the set engine speed can be increased by pushing the up switch or decreased by pushing the down switch. Each time a switch is pushed, the beeper will sound one time quickly and the set

# Instrument operation

EJU34906

## Multifunction information center

The multifunction information center displays various watercraft information.

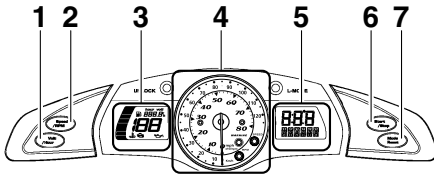

- 1 "Volt/Hour" button
- 2 "Speed/RPM" button
- 3 Information display
- 4 Analog speedometer/tachometer
- 5 Multifunction display (FX Cruiser SHO)
- 6 "Start/Stop" button (FX Cruiser SHO)
- 7 "Mode/Reset" button (FX Cruiser SHO)

### Multifunction information center initial operation

When the multifunction information center is activated, the analog speedometer/tachometer makes one sweep, all of the display segments and indicator lights come on. After 2 seconds, the "WARNING" indicator light and the warning indicators in the information display go off, and then the center starts to operate normally.

#### TIP:

The "UNLOCK" indicator light will go off when the engine is started.

### Multifunction information center standby state

If the multifunction information center does not receive any operation input within 25 seconds after the engine stops, the center will turn off and enter a standby state. When the engine is started again, the displays return to

their state before the center turned off, and then the center starts to operate normally.

EJU36794

## Analog speedometer/tachometer

The analog speedometer/tachometer has both a speedometer function and a tachometer function. By switching the meter, it can be used as either a speedometer or a tachometer.

#### TIP:

The analog speedometer is selected at the Yamaha factory.

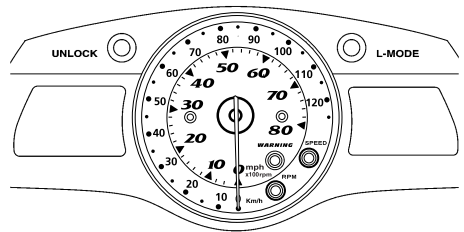

### Analog speedometer

The analog speedometer shows the watercraft speed against water.

The small outer numbers on the meter show the watercraft speed in kilometers per hour "km/h" and the large inner numbers show the speed in miles per hour "mph".

The "SPEED" indicator light comes on when the analog speedometer is selected.

To switch to the speedometer from the tachometer:

Push the "Speed/RPM" button for at least 1 second after the multifunction information center is activated. When the meter switches to the analog speedometer function, the "SPEED" indicator light comes on if "km/h" are selected as the display units. The "SPEED" indicator light blinks three times, then comes on, if "mph" are selected as the display units.

# Instrument operation

(See page 40 for information on switching the digital speedometer display units.)

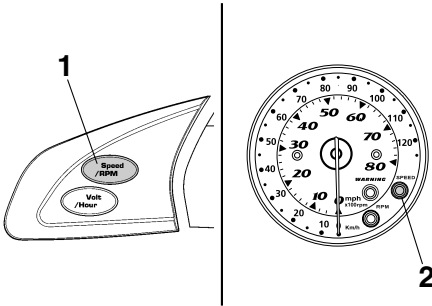

- 1 "Speed/RPM" button
- 2 "SPEED" indicator light

## Analog tachometer

The analog tachometer shows the engine speed.

The large inner numbers on the meter show the engine speed  $\times 100$  rpm (r/min).

The "RPM" indicator light comes on when the analog tachometer is selected.

To switch to the tachometer from the speedometer:

Push the "Speed/RPM" button for at least 1 second after the multifunction information center is activated. When the meter switches to the analog tachometer function, the "RPM" indicator light comes on.

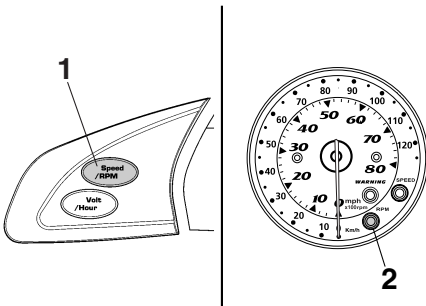

- 1 "Speed/RPM" button
- 2 "RPM" indicator light

EJU35023

## Information display

The information display shows watercraft operating conditions.

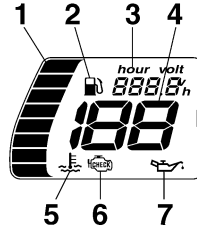

- 1 Fuel level meter
- 2 Fuel indicator
- 3 Hour meter/voltmeter
- 4 Digital speedometer
- 5 Engine overheat warning indicator
- 6 Check engine warning indicator
- 7 Oil pressure warning indicator

EJU37084

## Digital speedometer

The digital speedometer shows the watercraft speed against water.

By switching the display units, the speed can be shown in kilometers per hour (km/h) or miles per hour (mph).

### TIP:

Kilometers are selected as the display units at the Yamaha factory.



- 1 Digital speedometer

# Instrument operation

## Digital speedometer display (km/h)

The "SPEED" indicator light blinks once if kilometers are selected as the display units when the multifunction information center is activated.

### TIP:

If the analog speedometer is selected, the "SPEED" indicator light blinks once, then comes on.

## Digital speedometer display (mph)

The "SPEED" indicator light blinks three times if miles are selected as the display units when the multifunction information center is activated.

### TIP:

If the analog speedometer is selected, the "SPEED" indicator light blinks three times, then comes on.

To switch the digital speedometer display units:

Push the "Volt/Hour" button for at least 1 second, within 10 seconds after the multifunction information center is activated. The digital speedometer display changes. When the display units are switched from kilometers to miles only, the "SPEED" indicator light blinks three times.

EJU35064

## Hour meter/voltmeter

The hour meter/voltmeter has both an hour meter function and a voltmeter function. By switching the meter, it can be used as either an hour meter or a voltmeter.

### TIP:

The hour meter is selected at the Yamaha factory.

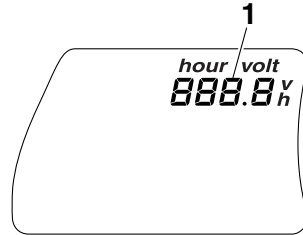

1 Hour meter/voltmeter

## Hour meter

The hour meter shows the total number of hours that the engine has been running since the watercraft was new.

### TIP:

The elapsed time will be kept even if the battery terminals have been disconnected.

To switch to the hour meter from the voltmeter:

Push the "Volt/Hour" button for at least 1 second after the multifunction information center is activated for more than 10 seconds. The

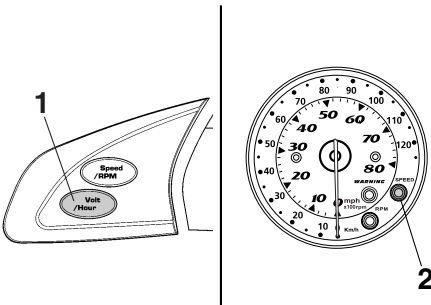

1 "Volt/Hour" button

2 "SPEED" indicator light



# Instrument operation

display switches to the hour meter from the voltmeter.

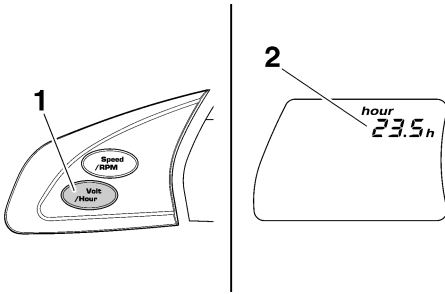

- 1 "Volt/Hour" button
- 2 Hour meter

## Voltmeter

The voltmeter shows the battery voltage.

When the battery voltage is normal, the voltmeter displays approximately 12 volts.

If the battery voltage has dropped significantly, "LO" is displayed on the voltmeter. If the battery voltage has risen significantly, "HI" is displayed. If "LO" or "HI" is displayed, immediately return to shore and have a Yamaha dealer service the watercraft.

To switch to the voltmeter from the hour meter:

Push the "Volt/Hour" button for at least 1 second after the multifunction information center is activated for more than 10 seconds. The display switches to the voltmeter from the hour meter.

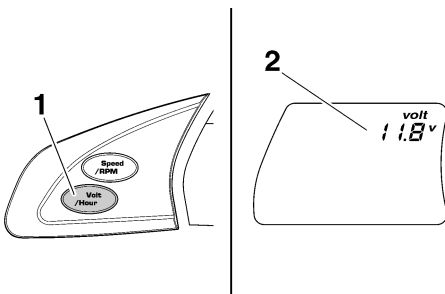

- 1 "Volt/Hour" button
- 2 Voltmeter

EJU31514

## Fuel level meter

The fuel level meter shows the amount of fuel remaining in the fuel tank. The amount of remaining fuel is shown using eight display segments, which disappear two at a time as the fuel level decreases.

### TIP:

The accuracy of the fuel level meter varies depending on the operating conditions. Use this function as a reference only.

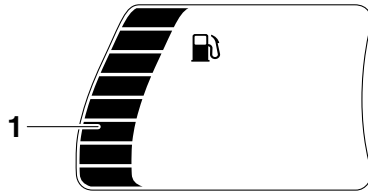

- 1 Fuel level meter

EJU36815

## Fuel level warning

If the fuel remaining in the fuel tank drops to about 18 L (4.8 US gal, 4.0 Imp. gal), the "WARNING" indicator light, the fuel indicator, and the lowest two fuel level segments blink, and the buzzer sounds intermittently.

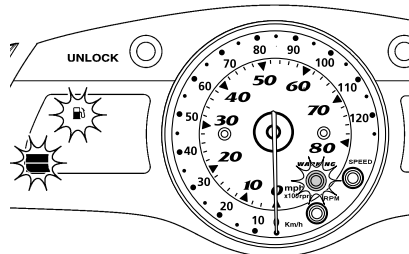

If the fuel level warning is activated, refill the fuel tank as soon as possible. (See page 54 for information on filling the fuel tank.)

# Instrument operation

After the fuel tank is refilled, the warning signals will be cleared when the engine is restarted.

## TIP:

Push any button on the multifunction information center to stop the buzzer.

EJU35126

### Oil pressure warning

If the oil pressure drops significantly, the “WARNING” indicator light and the oil pressure warning indicator blink, and the buzzer sounds intermittently. At the same time, the engine speed is limited.

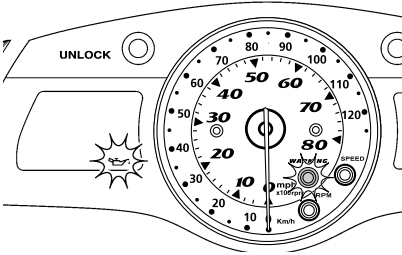

If the oil pressure warning is activated, immediately reduce the engine speed, return to shore, and then check the engine oil level. (See page 56 for information on checking the engine oil level.) If the oil level is sufficient, have a Yamaha dealer check the watercraft.

## TIP:

Push any button on the multifunction information center to stop the buzzer.

EJU36826

### Engine overheat warning

If the engine temperature rises significantly, the “WARNING” indicator light and the engine overheat warning indicator blink, and the buzzer sounds intermittently. Then, the “WARNING” indicator light and the engine overheat warning indicator stop blinking and remain on, and the buzzer sounds continuously. After the light and indicator start to blink

and the buzzer sounds, the engine speed is limited.

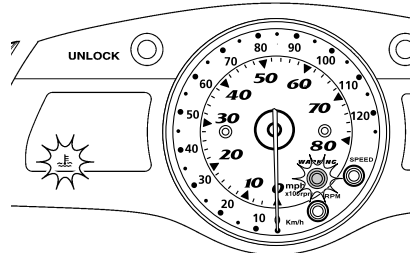

If the engine overheat warning is activated, immediately reduce the engine speed, return to shore, and then make sure that water is being discharged from the port (left) cooling water pilot outlets while the engine is running. If there is no discharge of water, stop the engine, and then check the jet intake for clogging. (See page 97 for information on the jet intake.) **NOTICE: If you cannot locate and correct the cause of the overheating, consult a Yamaha dealer. Continuing to operate at higher speeds could result in severe engine damage.** [ECJ00041]

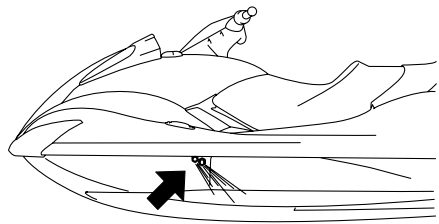

## TIP:

Push any button on the multifunction information center to stop the buzzer.

# Instrument operation

EJU35133

## Check engine warning

If a sensor malfunction or a short circuit is detected, the “WARNING” indicator light and the check engine warning indicator blink, and the buzzer sounds intermittently.

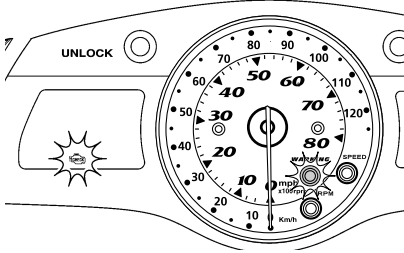

If the check engine warning is activated, immediately reduce the engine speed, return to shore, and have a Yamaha dealer check the engine.

### TIP:

Push any button on the multifunction information center to stop the buzzer.

EJU35037

## Multifunction display (FX Cruiser SHO)

The multifunction display shows the following information.

The display units of the multifunction display are selected according to the display units of the digital speedometer. (To change the display units, see page 40 for digital speedometer display selection procedures.)

When “km/h” are selected as the display units of the digital speedometer, values are shown in kilometers/liters/degrees Celsius.

When “mph” are selected as the display units of the digital speedometer, values are shown in miles/gallons/degrees Fahrenheit.

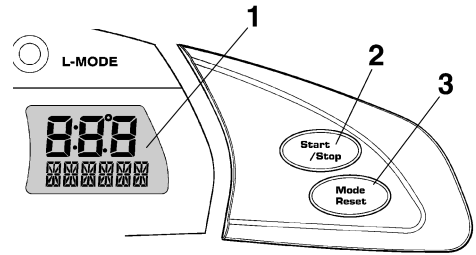

- 1 Multifunction display
- 2 “Start/Stop” button
- 3 “Mode/Reset” button

To switch the display mode, push the “Mode/Reset” button for less than 1 second. The display mode changes in the following order.

### Compass

This display shows the current direction of the watercraft using the 8 major compass points.

### TIP:

The accuracy of the compass varies depending on the operating conditions. Use this function as a reference only.

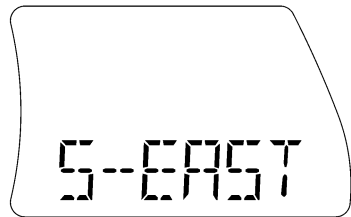

### Average speed

This display shows the average speed in kilometers per hour “AV KMH” or miles per hour

# Instrument operation

---

“AV MPH” since the measurement was started.

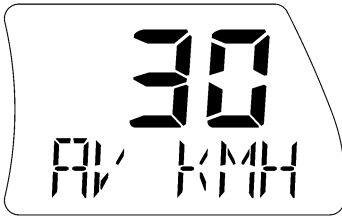

## Tripmeter

This display shows the distance traveled in kilometers “KM” or miles “MILES” since the measurement was started.

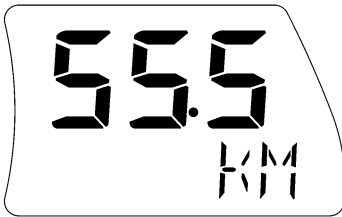

## Trip timer

This display shows the hours of operation “TRIP TM” since the measurement was started.



## Fuel consumption per hour

This display shows the current fuel consumption in liters per hour “L/HR” or gallons per hour “G/HR”.



## Fuel consumption per kilometer/mile

This display shows the current fuel consumption in liters per kilometer “L/KM” or gallons per mile “G/MILE”.

### TIP:

The actual fuel consumption varies greatly depending on the operating conditions. Use this function as a reference only.

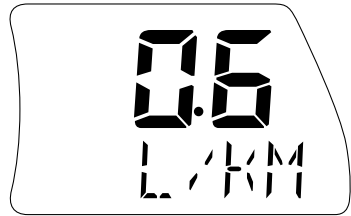

# Instrument operation

## Water temperature

This display shows the ambient water temperature “L TEMP” (lake temperature).

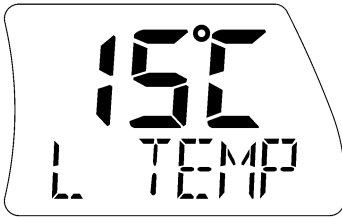

## Air temperature

This display shows the ambient air temperature “E TEMP” (environmental temperature).

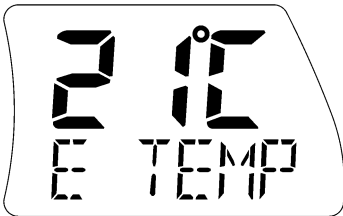

## Average speed/Tripmeter/Trip timer modes

Average speed, distance traveled, and trip time are recorded once the “Start/Stop” button is pushed to start the measurements, regardless of the current display.

### TIP:

The measurements are performed only while the engine is running.

The measurements are not saved if the engine is stopped. The measurements are reset

automatically when the displays go off 25 seconds after the engine stops.

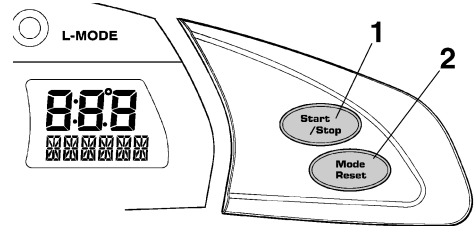

1 “Start/Stop” button

2 “Mode/Reset” button

### To start the measurements:

Push the “Start/Stop” button for less than 1 second. The beeper sounds once and the measurements start.

### To stop the measurements:

Push the “Start/Stop” button for less than 1 second while the measurements are being recorded. The beeper sounds once and the measurements stop.

### To restart the measurements:

Push the “Start/Stop” button for less than 1 second while the measurements are stopped. The beeper sounds once and the measurements restart.

### To reset the measurements:

Push the “Mode/Reset” button for at least 2 seconds while the measurements are stopped. The beeper sounds twice and the measurements are reset.

# Equipment operation

EJU40333

## Equipment

EJU31043

### Seats

The front and rear seats are removable. Remove the seats to access the engine compartment and seat storage compartment.

#### To remove the rear seat:

- (1) Pull the rear seat latch up, and then lift up the rear of the seat.

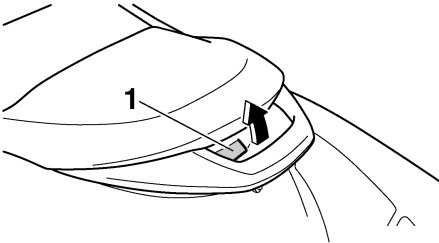

1 Seat latch

- (2) Pull the seat rearward and remove it.

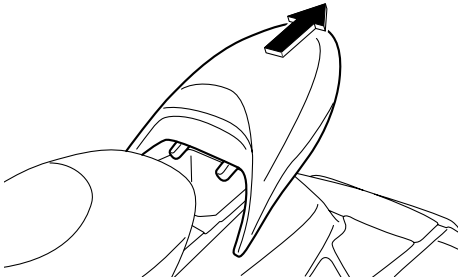

#### To install the rear seat:

- (1) Insert the projections on the front of the seat into the stays on the deck.

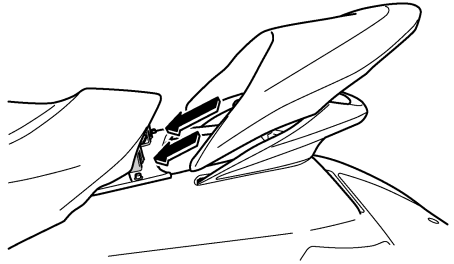

- (2) Push the rear of the seat down to securely lock it in place.

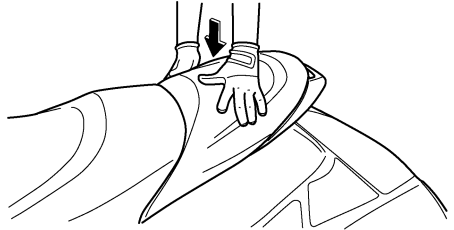

#### To remove the front seat:

- (1) Remove the rear seat.
- (2) Pull the front seat latch up, and then lift up the rear of the seat.

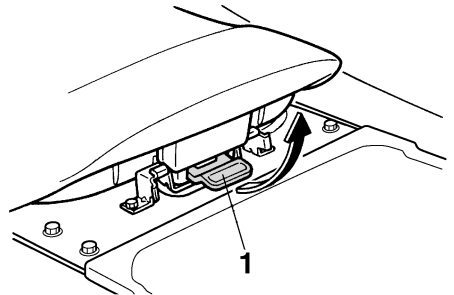

1 Seat latch

# Equipment operation

- (3) Pull the seat rearward and remove it.

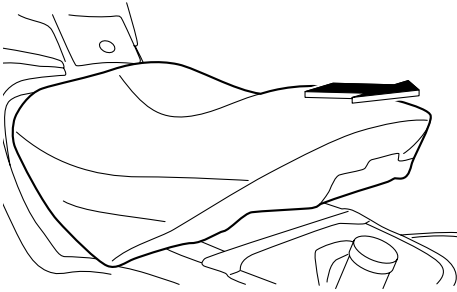

## To install the front seat:

- (1) Insert the projections on the front of the seat into the stays on the deck.

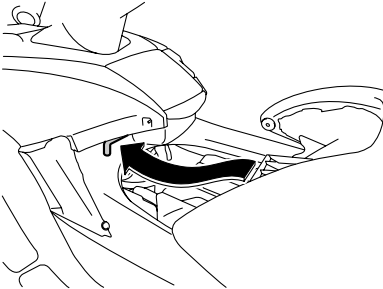

- (2) Push the rear of the seat down to securely lock it in place.

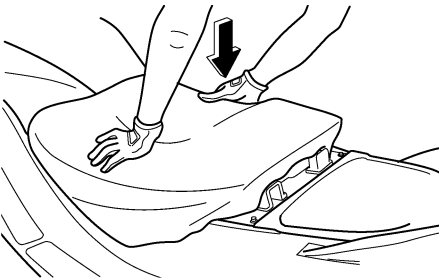

- (3) Securely install the rear seat in its original position.

EJU31362

## Handgrip

The handgrip is used when boarding the watercraft from the water and when the spotter is facing rearward. **WARNING! Do not use the handgrip to lift the watercraft. The handgrip is not designed to support the watercraft's weight. If the handgrip breaks, the watercraft could fall, which could result in severe injury.** [EWJ00021]

FX SHO

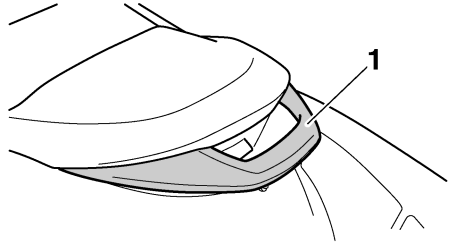

1 Handgrip

FX Cruiser SHO

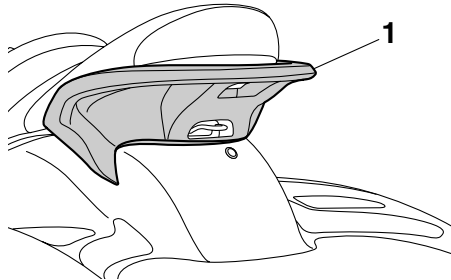

1 Handgrip

EJU34863

## Reboarding step

The reboarding step is used to make reboarding the watercraft easier from the water.

When boarding the watercraft, push the reboarding step down until it stops. The step returns automatically to its original position when released. **WARNING! Do not use the reboarding step to lift the watercraft. The**

# Equipment operation

reboarding step is not designed to support the watercraft's weight. If the reboarding step breaks, the watercraft could fall, which could result in severe injury. [EJWJ01211]

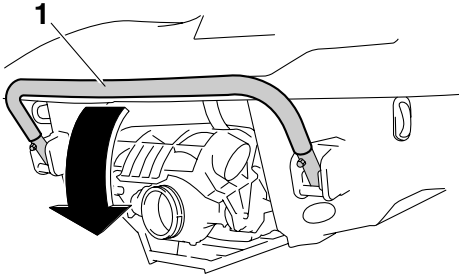

1 Reboarding step



ECJ00742

## NOTICE

Use the reboarding step only to board the watercraft in the water. Do not use the reboarding step for any other purpose. The watercraft can be damaged.

EJU34872

## Bow eye

The bow eye is used to attach a rope to the watercraft when transporting, mooring, or

towing it in an emergency. (See page 100 for information on towing the watercraft.)

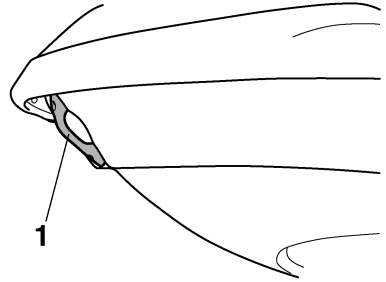

1 Bow eye

EJU34881

## Stern eyes

The stern eyes are used to attach a rope to the watercraft when transporting or mooring it.

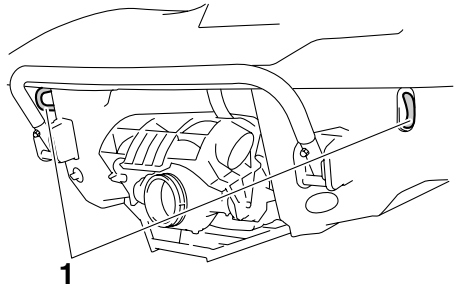

1 Stern eye

EJU40420

## Cleat

The cleat is used to attach a ski rope to the watercraft when pulling a water-skier. **WARNING! Do not use the cleat to lift the watercraft. The cleat is not designed to support the watercraft's weight. If the cleat**



# Equipment operation

breaks, the watercraft could fall, which could result in severe injury. [EWJ01510]

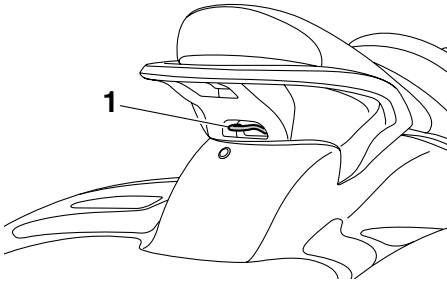

1 Cleat

EJU34892

## Pull-up cleats (FX Cruiser SHO)

The pull-up cleats are used to attach a rope to the watercraft when mooring it.

To use a pull-up cleat, pull it up. The pull-up cleat returns automatically to its original position when released. **WARNING! Do not use the pull-up cleats to lift the watercraft. The pull-up cleats are not designed to support the watercraft's weight. If the pull-up cleats break, the watercraft could fall, which could result in severe injury.** [EWJ00821]

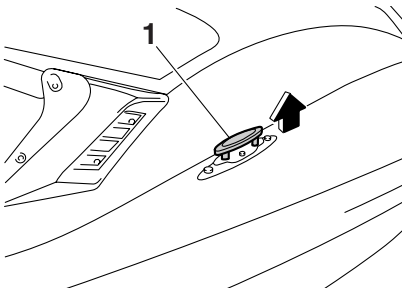

1 Pull-up cleat

EJU35146

## Storage compartments

This watercraft is equipped with the following storage compartments.

Only the securely closed watertight storage compartment is waterproof. If you carry ob-

jects that must be kept dry, put them in a waterproof bag.

Make sure that the storage compartments are closed securely before operating the watercraft.

EJU36835

## Bow storage compartment

The bow storage compartment is located under the hood.

To open the bow storage compartment:

Pull the visor up, and then lift up the rear of the hood.

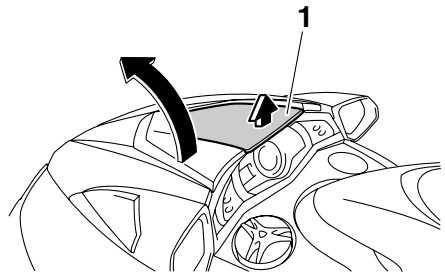

1 Visor

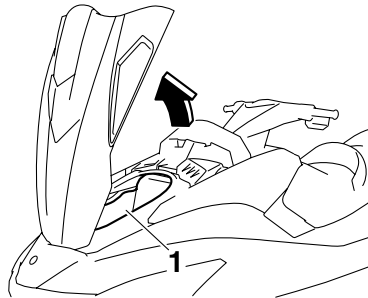

1 Bow storage compartment

Bow storage compartment:

Capacity:

66.0 L (17.4 US gal, 14.5 Imp.gal)

Load limit:

5.0 kg (11 lb)

# Equipment operation

## To close the bow storage compartment:

Push the center of the hood down to securely lock it in place.

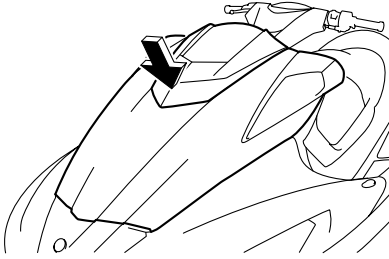

## To drain water from the bow storage compartment:

- (1) Remove the drain plug on the bottom of the storage compartment to drain the water into the engine compartment.

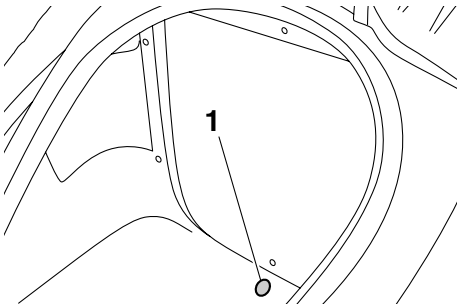

1 Drain plug

- (2) Securely install the drain plug in its original position.

EJU35163

## **Glove compartment**

The glove compartment is located in front of the seat.

## To open the glove compartment:

Turn the glove compartment knob 90° to the left or right, and then lift up the lid.

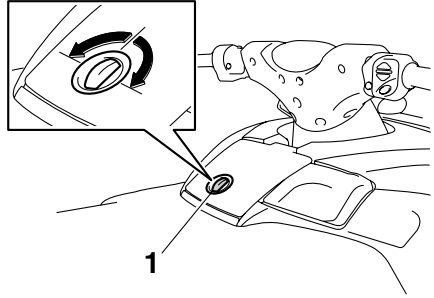

1 Glove compartment knob

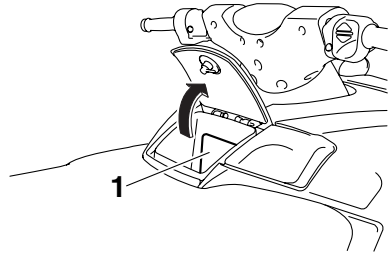

1 Glove compartment

### Glove compartment:

Capacity:

5.9 L (1.6 US gal, 1.3 Imp.gal)

Load limit:

1.0 kg (2 lb)

# Equipment operation

## To close the glove compartment:

Lower the lid, and then turn the glove compartment knob to securely lock the lid in place.

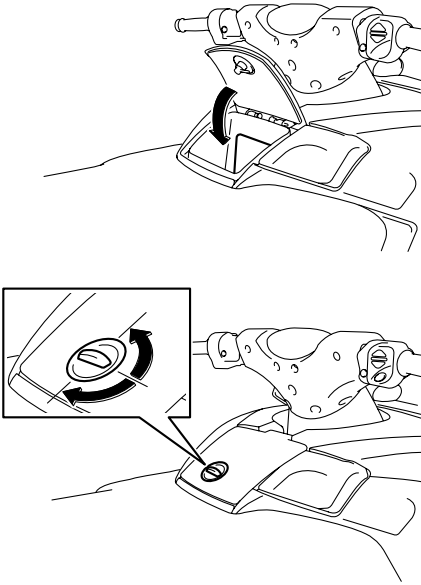

## To drain water from the glove compartment:

(1) Remove the drain plug on the bottom of the glove compartment to drain the water.

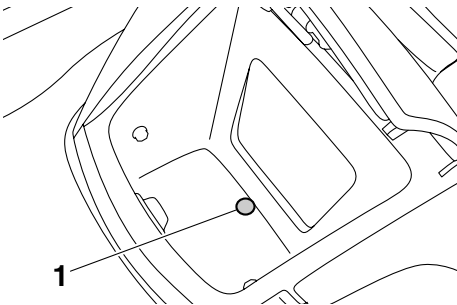

1 Drain plug

(2) Securely install the drain plug in its original position.

EJU31762

## **Seat storage compartment**

The seat storage compartment is located under the rear seat.

The storage compartment is removable.

## To open the seat storage compartment:

Remove the rear seat. (See page 47 for seat removal and installation procedures.)

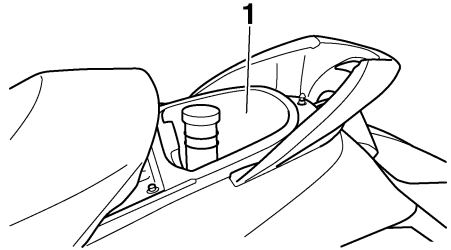

1 Seat storage compartment

## **Seat storage compartment:**

Capacity:

15.0 L (4.0 US gal, 3.3 Imp.gal)

Load limit:

9.0 kg (20 lb)

## To close the seat storage compartment:

Securely install the rear seat in its original position.

# Equipment operation

EJU35174

## Beverage holder

The beverage holder is located near the starboard (right) side of the multifunction information center.

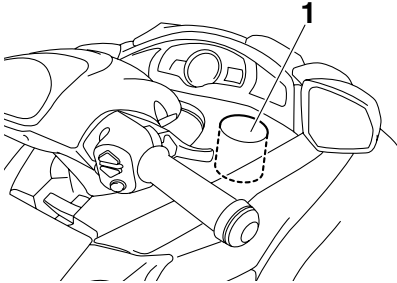

1 Beverage holder

Do not place any items in the beverage holder while riding. Otherwise, the items may fall out of the beverage holder.

EJU35188

## Watertight storage compartment

The watertight storage compartment is located near the port (left) side of the multifunction information center.

The compartment is watertight when the cap is closed securely.

To open the watertight storage compartment:  
Loosen the cap and remove it.

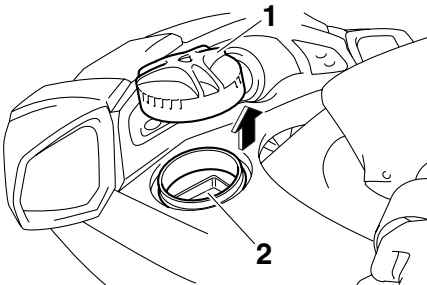

1 Watertight storage compartment cap  
2 Watertight storage compartment

Watertight storage compartment:

Capacity:

2.7 L (0.7 US gal, 0.6 Imp.gal)

Load limit:

1.0 kg (2 lb)

To close the watertight storage compartment:  
Securely install the cap by tightening it until it stops.

EJU40911

## Fire extinguisher container

The fire extinguisher container is located in the seat storage compartment.

To open the fire extinguisher container:

- (1) Remove the rear seat. (See page 47 for seat removal and installation procedures.)
- (2) Loosen the fire extinguisher container cap and remove it.

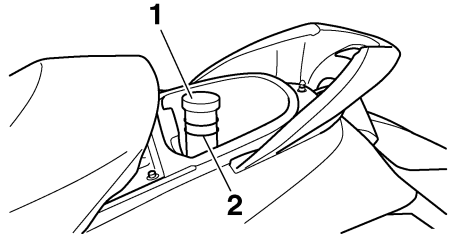

1 Fire extinguisher container cap  
2 Fire extinguisher container

To close the fire extinguisher container:

- (1) Insert the fire extinguisher into the container, and then securely install the fire extinguisher container cap by tightening it until it stops.
- (2) Securely install the rear seat in its original position.

# Operation and handling requirements

EJU31822

## Fuel requirements

EJU37225

### Fuel

EWJ00282

#### **WARNING**

- Gasoline and gasoline vapors are extremely flammable. To avoid fires and explosions and to reduce the risk of injury when refueling, follow these instructions.
- Gasoline is poisonous and can cause injury or death. Handle gasoline with care. Never siphon gasoline by mouth. If you should swallow some gasoline, inhale a lot of gasoline vapor, or get some gasoline in your eyes, see your doctor immediately. If gasoline spills on your skin, wash with soap and water. If gasoline spills on your clothing, change your clothes.

ECJ00321

#### **NOTICE**

- Do not use leaded gasoline. Leaded gasoline can seriously damage the engine.
- Avoid getting water and contaminants in the fuel tank. Contaminated fuel can cause poor performance and engine damage. Use only fresh gasoline that has been stored in clean containers.

#### Recommended fuel:

Regular unleaded gasoline with a minimum octane rating of

86

(Pump octane number) =  $(R + M)/2$

90 (Research octane number)

## Gasohol

There are two types of gasohol: gasohol containing ethanol and that containing methanol. Gasohol containing ethanol can be used if ethanol content does not exceed 10% and the

fuel meets the minimum octane ratings. E-85 is a fuel blend containing 85% ethanol and therefore must not be used in this watercraft. All ethanol blends containing more than 10% ethanol can cause fuel system damage or engine performance problems.

Yamaha does not recommend gasohol containing methanol because it can cause fuel system damage and engine performance problems.

#### To fill the fuel tank:

- (1) Before refueling, stop the engine. Do not stand or sit on the watercraft. Never refuel while smoking, or while in the vicinity of sparks, open flames, or other sources of ignition.
- (2) Place the watercraft in a well-ventilated area and in a horizontal position.
- (3) Remove the seats, and then check the fuel level. (See page 47 for seat removal and installation procedures.)
- (4) Pull the visor up, and then lift up the rear of the hood.

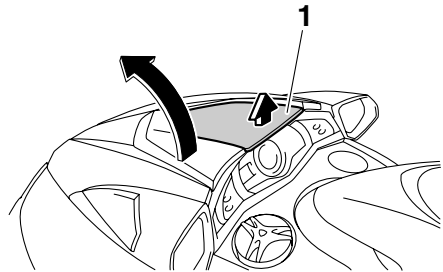

1 Visor

# Operation and handling requirements

- (5) Loosen the fuel filler cap and remove it.

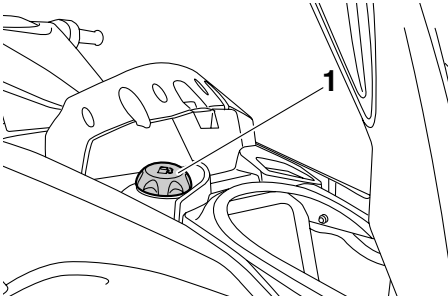

1 Fuel filler cap

- (6) Slowly add fuel to the fuel tank.

Fuel tank capacity:  
70 L (18.5 US gal, 15.4 Imp.gal)



- (7) Stop filling when the fuel level reaches approximately 50 mm (2 in) from the top of the fuel tank. Do not overfill the fuel tank. Because fuel expands when it heats up, heat from the engine or the sun can cause fuel to spill out of the fuel tank. Do

not leave the watercraft with a full tank in direct sunlight.

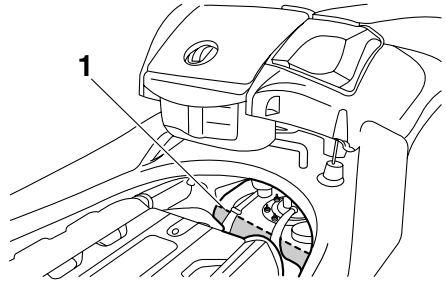

1 Approximately 50 mm (2 in) from top of the fuel tank

- (8) Wipe up any spilled fuel immediately with a dry cloth.  
(9) Securely install the fuel filler cap by tightening it until it clicks.  
(10) Push the center of the hood down to securely lock it in place. Make sure that the fuel filler cap and the hood are securely closed before using the watercraft.

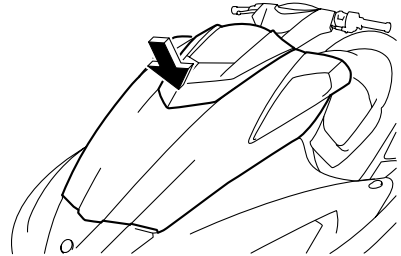

- (11) Securely install the seats in their original positions.

# Operation and handling requirements

EJU40290

## Engine oil requirements

EJU31893

### Engine oil

ECJ00281

#### NOTICE

**Use only 4-stroke engine oil. Usage of 2-stroke engine oil could result in severe engine damage.**

Recommended engine oil:  
Yamalube 4W  
Recommended engine oil type:  
SAE 10W-30, 10W-40, 20W-40, 20W-50  
Recommended engine oil grade:  
API SE,SF,SG,SH,SJ,SL

### Checking the engine oil level

EWJ00340

#### WARNING

**Engine oil is extremely hot immediately after the engine is turned off. Coming in contact with or getting any engine oil on your clothes could result in burns.**

ECJ01001

#### NOTICE

**Make sure that debris and water do not enter the oil filler hole. Debris and water in the engine oil can cause serious engine damage.**

To check the engine oil level:

- (1) Place the watercraft in a precisely level position on land with the engine stopped. If the engine was running, allow the engine oil to settle by waiting 5 minutes or more before checking the oil level.
- (2) Remove the seats. (See page 47 for seat removal and installation procedures.)

- (3) Remove the dipstick and wipe it clean.

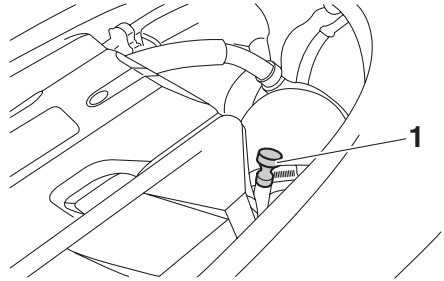

1 Dipstick

- (4) Insert the dipstick back into the dipstick tube completely. Remove the dipstick again and make sure that the engine oil level is between the minimum and maximum level marks.

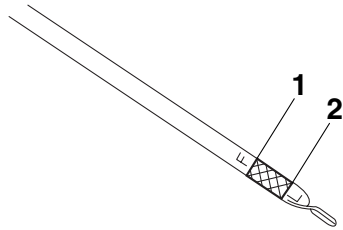

1 Maximum level mark

2 Minimum level mark

- (5) If the engine oil level is significantly above the maximum level mark, consult a Yamaha dealer. If the engine oil level is below the minimum level mark, add engine oil.

# Operation and handling requirements

- (6) Loosen the engine oil filler cap and remove it.

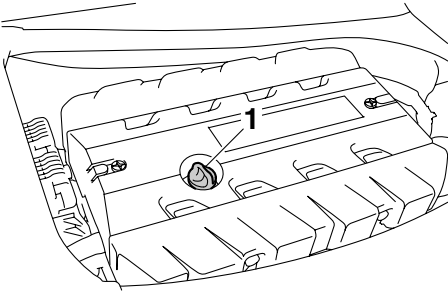

1 Engine oil filler cap

- (7) Slowly add engine oil.

## TIP:

The difference between the minimum and maximum level marks on the dipstick is equal to approximately 1 L (1.06 US qt, 0.88 Imp. qt) of engine oil.

- (8) Wait approximately 5 minutes to allow the engine oil to settle, and then check the engine oil level again.
- (9) Repeat steps 3–8 until the engine oil is at the proper level.
- (10) Securely install the engine oil filler cap by tightening it until it stops.
- (11) Securely install the seats in their original positions.

EJU40021

## Draining the bilge water

ECJ01301

### NOTICE

**Do not run the engine at full throttle when bilge water remains in the engine compartment. The bilge water can splash into the engine, which can result in severe damage.**

EJU40033

## Draining the bilge water on land

To drain the bilge water on land:

- (1) Loosen the stern drain plugs and remove them.

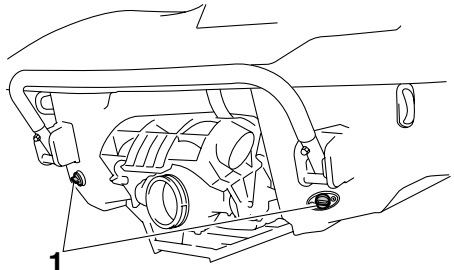

1 Stern drain plug

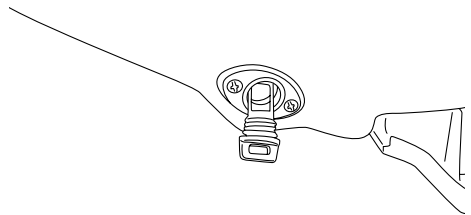

- (2) Raise the bow of the watercraft, such as by placing the watercraft on a slope, to drain the bilge water from the engine compartment.
- (3) After the bilge water has drained from the stern drain plug holes, wipe up any re-



# Operation and handling requirements

maining moisture in the engine compartment with a dry cloth.

- (4) Securely install the stern drain plugs by tightening them until they stop. **NOTICE:** Before installing the stern drain plugs, clean the drain plug threads to remove any foreign materials, such as dirt or sand. Otherwise, the stern drain plugs could be damaged, allowing water to enter the engine compartment. Make sure that the stern drain plugs are tightened securely before launching the watercraft. Otherwise, water may flood the engine compartment and cause the watercraft to submerge.

[ECJ00361]

EJU40042

## Draining the bilge water on water

A small quantity of bilge water will remain in the engine compartment even after the bilge water is drained on water. To completely drain the bilge water, remove the watercraft from the water and drain the bilge water on land.

## Jet vacuum bilge draining system

While the watercraft is operating, bilge water that collects in the engine compartment is drawn in by the vacuum that is generated in the jet pump and discharged from the watercraft through the jet thrust nozzle.

### To drain the bilge water on water:

Operate the watercraft as straight as possible and above planing speed for at least 2 minutes. **NOTICE:** Do not run the engine at full throttle for at least 1 minute after the engine has been restarted. Bilge water in the engine compartment can splash into the

engine, which can result in severe damage. [ECJ00553]

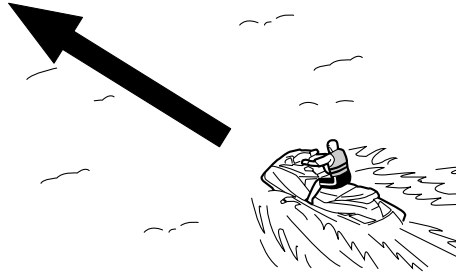

## Electric bilge draining system

Bilge water that collects in the engine compartment is drawn in by the operation of the electric bilge pump and discharged from the watercraft through the electric bilge pilot outlet.

To check for proper operation of the electric bilge draining system, make sure that bilge water is being discharged from the electric bilge pilot outlet.

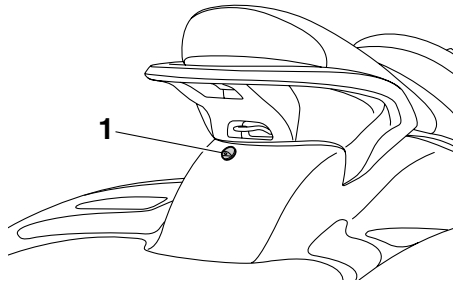

1 Electric bilge pilot outlet

### To drain the bilge water:

Start the engine to operate the electric bilge pump.

## TIP:

The electric bilge pump continues to operate for a short time after the engine stops.

# Operation and handling requirements

---

EJU33463

## Transporting on a trailer

When transporting the watercraft on a trailer, secure the tie downs to the trailer through the bow eye and stern eyes. **NOTICE: Do not attach ropes or tie downs to any part of the watercraft other than the bow eye and stern eyes to secure the watercraft to the trailer. Otherwise, the watercraft may be damaged. Wrap the ropes or tie downs with towels or rags where they touch the body of the watercraft to avoid scratches or damage. Do not transport the watercraft with the shift lever in the reverse position. Otherwise, the reverse gate may hit an obstacle, which could cause damage.** [ECJ00643]

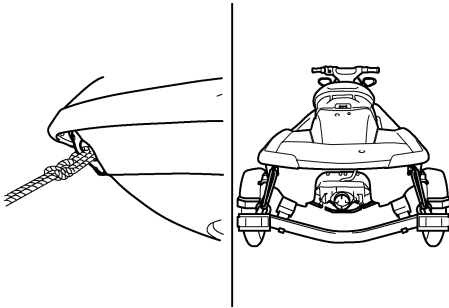

EJU36665

## Engine break-in

ECJ00431

### **NOTICE**

---

**Failure to perform the engine break-in could result in reduced engine life or even severe engine damage.**

---

The engine break-in is essential to allow the various components of the engine to wear and polish themselves to the correct operating clearances. This ensures proper performance and promotes longer component life.

To perform the engine break-in:

- (1) Check the engine oil level. (See page 56 for information on checking the engine oil level.)
- (2) Launch the watercraft and start the engine. (See page 72 for information on starting the engine.)
- (3) For the first 5 minutes, operate with the engine speed at 2000 r/min.
- (4) For the next 30 minutes, operate with the engine speed below 5000 r/min.
- (5) For the next 1 hour, operate with the engine speed below 6000 r/min.

After the engine break-in is complete, the watercraft can be operated normally.

# Pre-operation checks

EJU31981

EWJ00411



Failure to inspect or maintain the watercraft properly increases the possibility of an accident or damage to the watercraft. Do not operate the watercraft if you find any problem. If a problem cannot be corrected by the procedures provided in this manual, have the watercraft inspected by a Yamaha dealer.

EJU41232

## Pre-operation checklist

Before using this watercraft, be sure to perform the checks in the following checklist.

ITEM	ROUTINE	PAGE
<b>PRE-LAUNCH CHECKS</b>		
<b>Engine compartment</b>	Ventilate the engine compartment. Check inside the engine compartment for damage.	63
<b>Fuel system</b>	Check the fuel system for leakage. Check the fuel level in the fuel tank.	63
<b>Water separator</b>	Check the water separator for water.	63
<b>Engine unit</b>	Check the exterior of the engine unit for damage.	64
<b>Engine oil level</b>	Check the engine oil level.	64
<b>Bilge water</b>	Check the engine compartment for bilge water.	64
<b>Battery</b>	Check the battery connections and electrolyte level.	64
<b>Steering system</b>	Check the steering system for proper operation.	65
<b>Adjustable tilt steering system</b>	Check the adjustable tilt steering system for proper operation and check that the handlebars are securely locked in place.	65
<b>Q.S.T.S.</b>	Check the Q.S.T.S. for proper operation and check that the Q.S.T.S. selector is securely locked in place.	66
<b>Reverse system</b>	Check the reverse system for proper operation.	66
<b>Throttle lever</b>	Check the throttle lever for proper operation. Check the throttle lever free play.	67
<b>Remote control transmitter</b>	Check the remote control transmitter for proper operation.	67
<b>Engine shut-off cord (lanyard)</b>	Check the engine shut-off cord (lanyard) for damage.	67
<b>Switches</b>	Check the start switch, engine stop switch, and engine shut-off switch for proper operation.	68
<b>Storage compartments</b>	Check the storage compartments for damage and water.	68
<b>Fire extinguisher container</b>	Check the fire extinguisher container for damage.	68
<b>Fire extinguisher</b>	Check the condition of the fire extinguisher.	68
<b>Safety equipment</b>	Check that safety equipment meeting the applicable regulations is on board.	69
<b>Hull and deck</b>	Check the hull and deck for damage.	69

# Pre-operation checks

ITEM	ROUTINE	PAGE
<b>Jet intake</b>	Check the jet intake for damage and clogging.	69
<b>Stern drain plugs</b>	Check the stern drain plugs for damage and foreign material and check that they are securely installed.	69
<b>Hood</b>	Check that the hood is securely closed.	69
<b>Front and rear seats</b>	Check that the seats are securely installed.	47
<b>POST-LAUNCH CHECKS</b>		
<b>Cooling water pilot outlets</b>	Check that water is discharged from the cooling water pilot outlets while the engine is running.	70
<b>Multifunction information center</b>	Check the multifunction information center for proper operation.	70
<b>Engine idling speed</b>	Check the engine idling speed.	70

**TIP:**

To ensure safety and reliability, pre-operation checks should be made each time the watercraft is used.

# Pre-operation checks

EJU32281

## Pre-operation check points

EJU40096

### Pre-launch checks

Perform the pre-launch checks in the pre-operation checklist while the watercraft is on land.

To perform the pre-launch checks:

- (1) Remove the seats and seat storage compartment. (See page 47 for seat removal and installation procedures and page 52 for information on the seat storage compartment.)
- (2) Perform the checks and make sure that there are no malfunctioning items or other problems.
- (3) After completing these checks, securely install the seat storage compartment and seats in their original positions.

EJU32333

### Engine compartment check

EWJ00461

#### **! WARNING**

**Failure to ventilate the engine compartment could result in a fire or explosion. Do not start the engine if there is a fuel leak.**

Ventilate the engine compartment. Leave the engine compartment open for a few minutes to allow any fuel vapors to escape. Make sure that there is no damage inside the engine compartment.

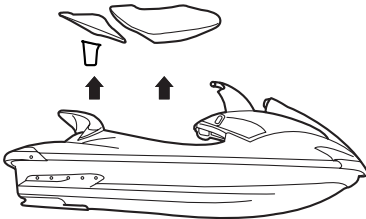

EJU34214

### Fuel system checks

EWJ00381

#### **! WARNING**

**Leaking fuel can result in fire or explosion.**

- Check for fuel leakage regularly.
- If any fuel leakage is found, the fuel system must be repaired by a qualified mechanic. Improper repairs can make the watercraft unsafe to operate.

Make sure that there is no damage, leakage, or other problem in the fuel system.

#### **Check:**

- Fuel filler cap and seal for damage
- Fuel tank for damage and leakage
- Fuel hoses and joints for damage and leakage
- Fuel tank breather hose for damage and leakage

EJU36874

### Fuel level check

Check the fuel level in the fuel tank.

Add fuel if necessary. (See page 54 for information on filling the fuel tank.)

EJU32423

### Water separator check

Make sure that no water has collected in the water separator. If water has collected in the water separator, drain it. (See page 31 for information on draining the water separator.)

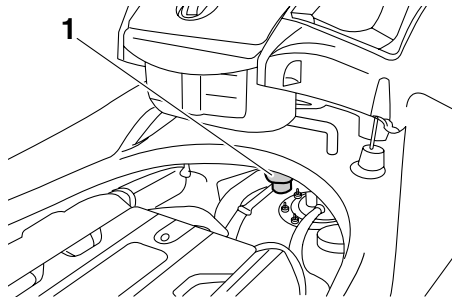

1 Water separator

# Pre-operation checks

EJU40181

## Engine unit check

Check the exterior of the engine unit for damage or other problem.

EJU36885

## Engine oil level check

Make sure that the engine oil level is between the minimum and maximum level marks on the dipstick. (See page 56 for information on checking the engine oil level.)

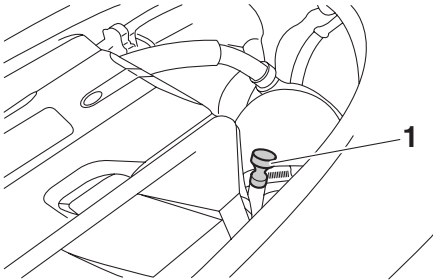

1 Dipstick

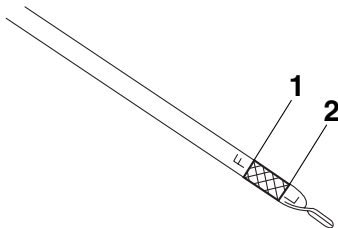

1 Maximum level mark

2 Minimum level mark

EJU32455

## Bilge water check

Make sure that no bilge water has collected in the engine compartment. If bilge water has collected in the engine compartment, drain it. (See page 57 for information on draining the bilge water.)

EJU32484

## Battery checks

Make sure that the battery terminals and breather hose are not damaged and that the battery leads and breather hose are connected properly. **WARNING! Fire or explosion could result if the breather hose is damaged, obstructed, or not connected properly.** [EWJ00451]

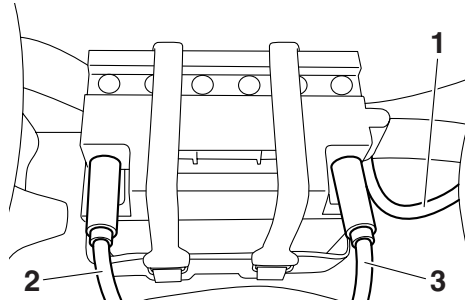

1 Breather hose

2 Negative (-) battery terminal: Black lead

3 Positive (+) battery terminal: Red lead

Make sure that the electrolyte level is between the minimum and maximum level marks. **WARNING! Never operate the watercraft if the battery does not have sufficient power to start the engine or if it shows any other signs of decreased power. Loss of battery power may leave you stranded.** [EWJ01240]

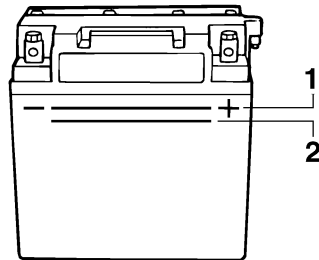

1 Maximum level mark

2 Minimum level mark

# Pre-operation checks

Make sure that the battery is securely held in place.

EJU32613

## Steering system checks

Turn the handlebars to the right and left several times to make sure that operation is smooth and unrestricted throughout the whole range, and that the free play is not excessive.

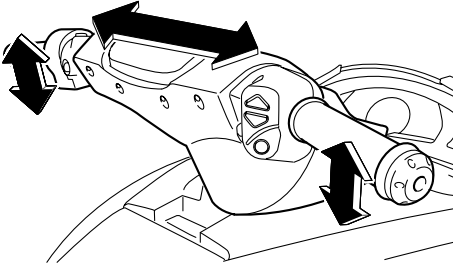

Turn the handlebars as far as possible to the right and left to make sure that the jet thrust nozzle moves as the handlebars are turned, and that there is no difference between the

right and left fully turned positions of the jet thrust nozzle.

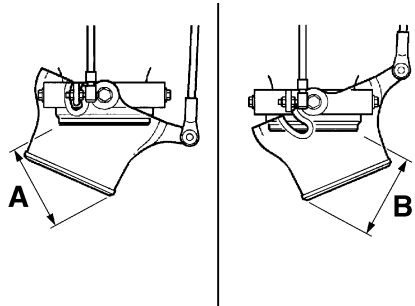
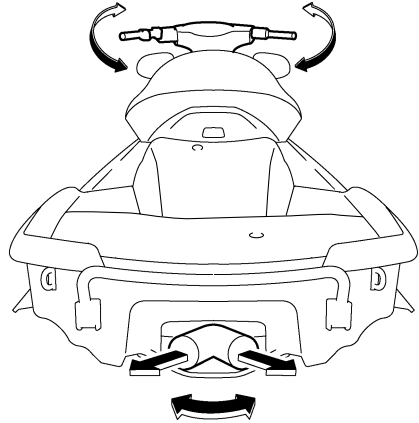

Difference between fully turned positions of jet thrust nozzle (distances A and B):  
Maximum 5 mm (0.20 in)

EJU40362

## Adjustable tilt steering system checks

Operate the adjustable tilt steering system several times to make sure that operation is smooth throughout the whole range. Also, make sure that the handlebars are securely



# Pre-operation checks

locked in place. (See page 30 for adjustable tilt steering system operation procedures.)

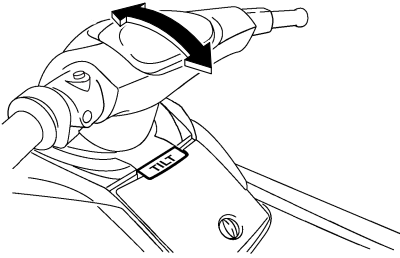

curly locks in place. (See page 33 for Q.S.T.S. operation procedures.)

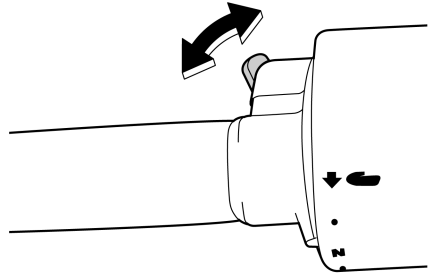

EJU32644

## Quick Shift Trim System (Q.S.T.S.) checks

Operate the Q.S.T.S. selector lock lever and the Q.S.T.S. selector several times to make sure that operation is smooth throughout the whole range. Also, make sure that the jet thrust nozzle moves as the Q.S.T.S. selector is operated and that the Q.S.T.S. selector se-

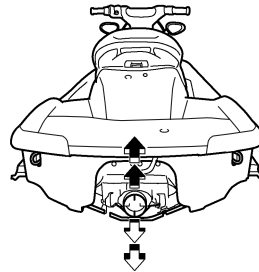
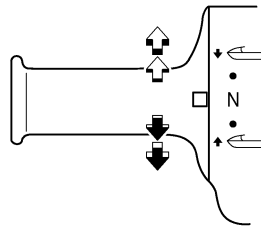

EJU32634

## Reverse system checks

EWJ00031



**Do not touch the reverse gate while the shift lever is being operated, otherwise you could be pinched.**

Operate the shift lever several times to make sure that operation is smooth throughout the whole range. Also, make sure that the reverse

# Pre-operation checks

gate moves up and down according to the operation of the shift lever and that the gate makes contact with the stoppers. (See page 32 for reverse system operation.)

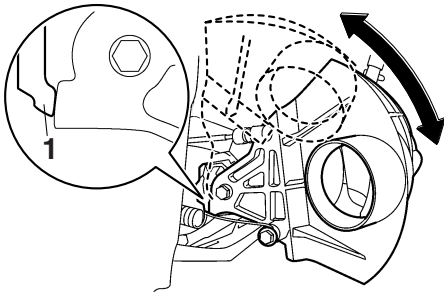
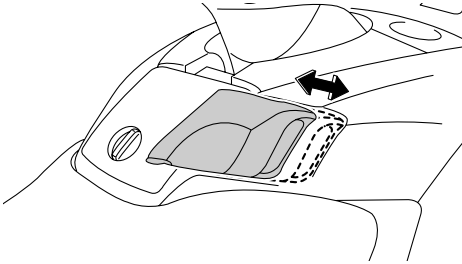

1 Stopper

EJU41220

## Throttle lever checks

Operate the throttle lever several times to make sure that operation is smooth throughout the whole range. Also, make sure that the throttle lever returns automatically to its fully closed (idle) position when released.

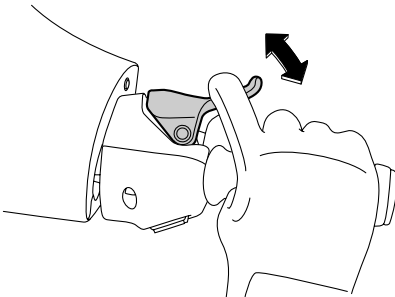

Face the handlebars straight ahead with the throttle lever in the fully closed (idle) position, and then make sure that there is the proper amount of throttle lever free play when the throttle lever is in the fully closed (idle) position.

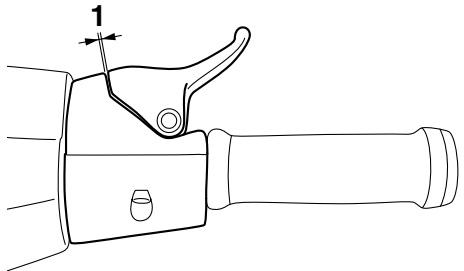
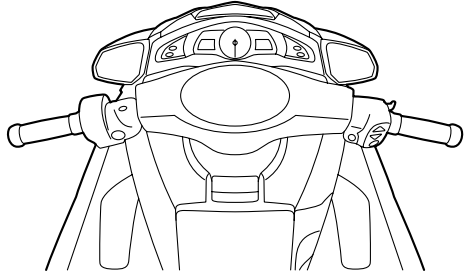

1 Throttle lever free play

Throttle lever free play: 2.0–5.0 mm (0.08–0.20 in)
--

EJU40112

## Remote control transmitter check

Make sure that the remote control transmitter operates properly. (See page 27 for Yamaha Security System setting procedures and page 34 for Low RPM Mode activation procedures.)

EJU32663

## Engine shut-off cord (lanyard) check

Make sure that the engine shut-off cord (lanyard) is not damaged. If the cord is damaged, replace it. **WARNING! Never try to repair the engine shut-off cord (lanyard) or tie it together. The engine shut-off cord (lan-**

# Pre-operation checks

yard) may not pull free when the operator falls off, allowing the watercraft to continue to run and cause an accident. [EJWJ01220]

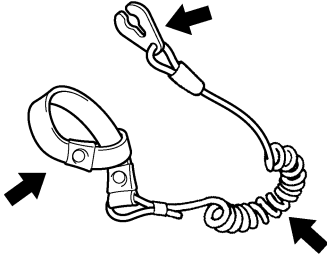

EJU32674

## Switch checks

ECJ01310

### NOTICE

**Do not run the engine over 4000 r/min on land. Also, do not run the engine for more than 15 seconds without supplying water, otherwise the engine could overheat.**

Check the start switch, the engine stop switch, and the engine shut-off switch for proper operation. (See pages 28 to 28 for information on operating each switch.)

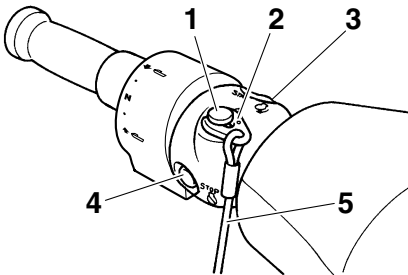

- 1 Engine shut-off switch
- 2 Clip
- 3 Start switch
- 4 Engine stop switch
- 5 Engine shut-off cord (lanyard)

To check the operation of the switches:

- (1) If the lock mode is selected for the Yamaha Security System setting, select the unlock mode. (See page 27 for Yamaha Security System setting procedures.)
- (2) Push the start switch to make sure that the engine starts.
- (3) As soon as the engine starts running, push the engine stop switch to make sure that the engine stops immediately.
- (4) Restart the engine, and then pull the engine shut-off cord (lanyard) to remove the clip from the engine shut-off switch to make sure that the engine stops immediately.

EJU40101

## Storage compartment checks

Make sure that the storage compartments are not damaged and that water has not collected in the compartments. (See page 50 for information on the storage compartments.)

EJU41071

## Fire extinguisher container checks

Make sure that the fire extinguisher container is not damaged and is securely held in place. (See page 53 for information on the fire extinguisher container.)

EJU32583

## Fire extinguisher check

Check that there is a full fire extinguisher on board.

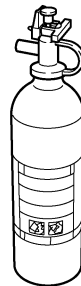

# Pre-operation checks

To check the fire extinguisher, see the instructions supplied by the fire extinguisher manufacturer. Always keep the fire extinguisher in the fire extinguisher container.

Always carry a fire extinguisher on board. A fire extinguisher is not standard equipment with this watercraft. If you do not have one, contact a Yamaha dealer or a fire extinguisher dealer to obtain one meeting the proper specifications.

EJU40121

## Safety equipment check

Check that safety equipment meeting the applicable regulations is on board.

EJU32352

## Hull and deck check

Check the hull and deck for damage or other problem.

EJU32656

## Jet intake checks

Make sure that the jet intake is not damaged or clogged with weeds or debris. If the jet intake is clogged, clean it. (See page 97 for information on the jet intake.)

EJU32475

## Stern drain plug checks

Loosen the stern drain plugs and remove them, and then make sure that the plugs are not damaged and that there is no foreign material on the threads. **NOTICE: Before installing the stern drain plugs, clean the drain plug threads to remove any foreign materials, such as dirt or sand. Otherwise, the stern drain plugs could be damaged, allowing water to enter the engine compartment. Make sure that the stern drain plugs are tightened securely before launching the watercraft. Otherwise, water may flood the engine compartment and cause the watercraft to submerge.** [ECJ00361]

Securely install the stern drain plugs by tightening them until they stop.

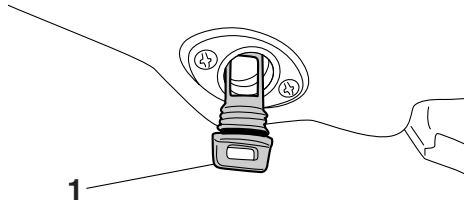

1 Stern drain plug

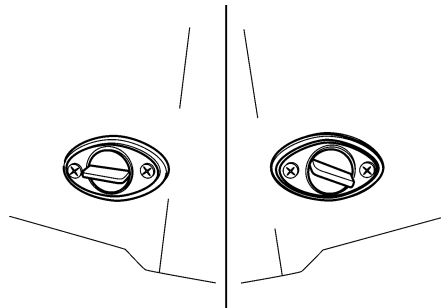

EJU40131

## Hood check

Push down on the center of the hood and make sure that it is securely closed.

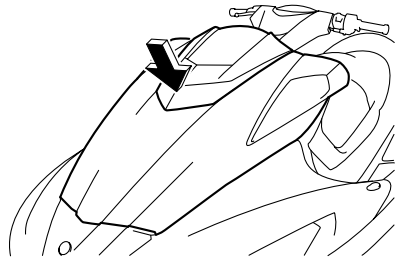

EJU40144

## Post-launch checks

Perform the post-launch checks in the pre-operation checklist while the watercraft is in the water and the engine is running.

# Pre-operation checks

To perform the post-launch checks:

- (1) Launch the watercraft. (See page 72 for information on launching the watercraft.)
- (2) Perform the checks and make sure that there are no malfunctioning items or other problems.

is not significantly above or below the specified range.

Engine idling speed: 1250 ±100 r/min
---

EJU36893

## Cooling water pilot outlet check

Make sure that water is discharged from the port (left) cooling water pilot outlets while the engine is running. (See page 30 for information on the cooling water pilot outlets.)

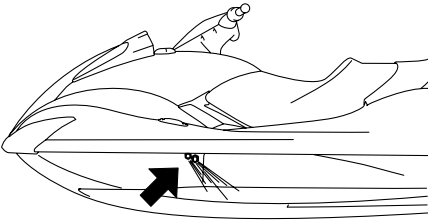

EJU32713

## Multifunction information center check

Make sure that the multifunction information center operates properly. (See page 39 for information on proper operation of the multifunction information center.)

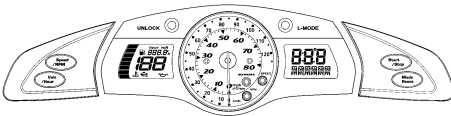

EJU40171

## Engine idling speed check

Start the engine and warm it up. Use the tachometer in the multifunction information center to make sure that the engine idling speed

# Operation

EJU32902

## Operating your watercraft

EWJ00510

### WARNING

**Before operating your watercraft, become familiar with all of the controls. Consult a Yamaha dealer about any control or function that you do not fully understand. Failure to understand how the controls work could cause an accident or prevent you from avoiding an accident.**

EJU32963

### Getting to know your watercraft

Operating your watercraft requires skills acquired through practice over a period of time. Take the time to learn the basic techniques well before attempting more difficult maneuvers.

Operating your new watercraft can be a very enjoyable activity, providing you with hours of pleasure. However, it is essential to familiarize yourself with the operation of the watercraft to achieve the skill level necessary to enjoy riding safely.

Before operating this watercraft, read this owner's/operator's manual, the Riding Practice Guide, the Riding Instruction card, and all labels on the watercraft. Pay particular attention to the safety information beginning on page 10. These materials should give you an understanding of the watercraft and its operation.

Remember: This watercraft is designed to carry the operator and up to 2 passengers. Never exceed the maximum load limit or allow more than 3 persons (or 2 persons if a water-skier is being pulled) to ride the watercraft at any time.

Maximum load:

240 kg (530 lb)

Load is the total weight of cargo, operator, and passengers.

EJU33005

### Learning to operate your watercraft

Before operating the watercraft, always perform the pre-operation checks listed on page 61. The short time spent checking the watercraft will reward you with added safety and reliability.

Check local laws before operating your watercraft.

Operate defensively at safe speeds and keep a safe distance away from people, objects, and other watercraft. Select a wide area to learn in, where there is good visibility and light boat traffic.

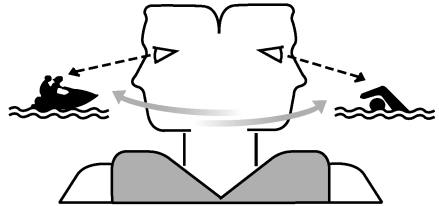

Use the buddy system—operate with someone nearby. Scan constantly for people, objects, and other watercraft. Be alert for conditions that limit your visibility or block your vision of others.

You should grip the handlebars firmly and keep both feet on the floor of the footwell. Do not attempt to ride with passengers until your operating skills are fully developed.

EJU40210

## Riding position

### Operator riding position

The operator should grip the handlebars firmly with both hands and sit astride the seat with both feet on the floor of the footwell.



### Passenger riding position

The passenger(s) should hold on firmly, either to the person in front of them or to the hand-grip provided, and sit astride the seat with their feet on the floor of the footwell. Never allow a passenger to ride in front of the operator. (See page 17 for information on the riding position when pulling a water-skier.)



EJU32802

## Launching the watercraft

When launching the watercraft, make sure that there are no obstacles around you. If the watercraft is launched from a trailer, someone should make sure that waves do not push the watercraft into the trailer.

EJU36344

## Starting the engine on water

EWJ01530

### WARNING

**Do not apply throttle when anyone is at the rear of the watercraft. Turn the engine off or keep it at idle. Water and debris exiting the jet thrust nozzle can cause severe injury.**

To start the engine:

- (1) If the lock mode is selected for the Yamaha Security System setting, select the unlock mode. (See page 27 for Yamaha Security System setting procedures.)
- (2) Move the watercraft to an area that is free from weeds and debris, and has a water depth of at least 60 cm (2 ft) from the bottom of the watercraft. **NOTICE: Never run the engine in water that is less than 60 cm (2 ft) deep from the bottom of the watercraft, otherwise pebbles or sand could be sucked into the jet intake, causing impeller damage and engine overheating.** [ECJ00472]

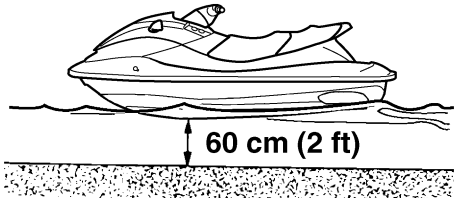

- (3) Attach the engine shut-off cord (lanyard) to your left wrist, and then attach the clip to the engine shut-off switch. (See page 28 for information on operating the engine shut-off switch.) **WARNING! Check that the engine shut-off cord (lanyard)**

# Operation

is attached correctly. If the engine shut-off cord (lanyard) is not attached correctly, it may not pull free when the operator falls off, allowing the watercraft to continue to run and cause an accident. [EWJ00581]

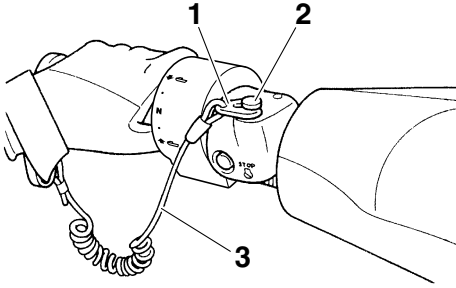

- 1 Clip
- 2 Engine shut-off switch
- 3 Engine shut-off cord (lanyard)

(4) With the throttle lever released, push the start switch (green button) to start the engine. (See page 28 for information on operating the start switch.)

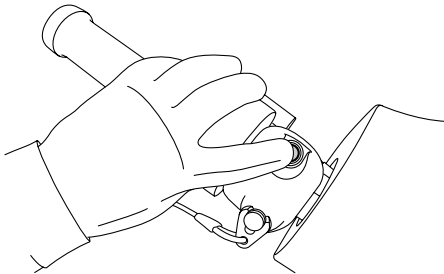

EJU32862

## Stopping the engine

Release the throttle lever, and then push the engine stop switch (red button) to stop the engine. **WARNING! You need throttle to steer. Shutting the engine off can cause you to hit an obstacle you are attempting to**

avoid. A collision could result in severe injury or death. [EWJ00601]

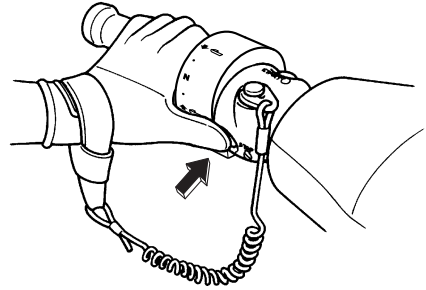

EJU32872

## Leaving the watercraft

If leaving the watercraft, remove the clip from the engine shut-off switch to prevent accidental starting or unauthorized operation by children or others.

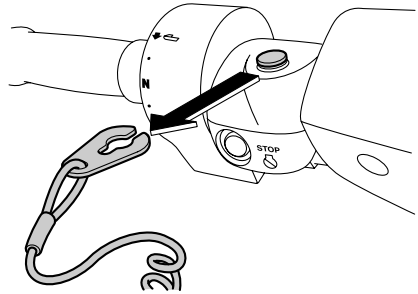

EJU40220

## Operating the watercraft

When the shift lever is in the forward position and the engine is running, the watercraft will move forward. The watercraft will move forward even if the throttle lever is in the fully closed (idle) position and the engine is at



idling speed. (See page 32 for information on operating the shift lever.)

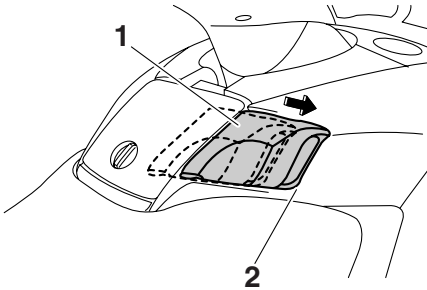

- 1 Shift lever
- 2 Forward position



EJU33254

## Turning the watercraft

EWJ00771

### **WARNING**

- Do not release the throttle lever when trying to steer away from objects—you need throttle to steer. A collision could result in severe injury or death.
- When operating at higher speeds, make gradual turns or slow down before turning. Sharp high-speed turns may cause the watercraft to slide sideways or spin, throwing the operator and passenger(s) overboard, which could cause an injury.

Steering control depends on the combination of handlebar position and the amount of throttle.

Water sucked in through the intake grate is pressurized by the impeller in the jet pump. As the pressurized water is expelled from the pump through the jet thrust nozzle, it creates thrust to move and steer the watercraft. The higher the engine speed, the more thrust produced.

The amount of jet thrust, in addition to the position of the handlebars, determines how sharply you turn.

- A. More throttle produces higher thrust, so the watercraft will turn more sharply.

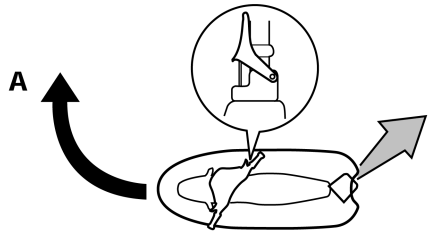

- B. Less throttle produces lower thrust, so the watercraft will turn more gradually.

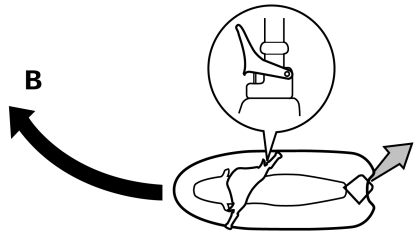

- C. Releasing the throttle lever completely produces only minimum thrust. If you are traveling at speeds above trolling, you will have rapidly decreasing ability to steer without throttle. You may still have some turning ability immediately after releasing the throttle lever, but once the engine

# Operation

slows down, the watercraft will no longer respond to handlebar input until you apply throttle again or you reach trolling speed.

At trolling speed, the watercraft can be turned gradually by handlebar position alone using just the amount of thrust available at idle.

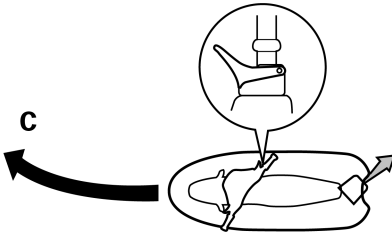

- D. If the engine is stopped while riding, there is no thrust. The watercraft will go straight even though the handlebars are turned.

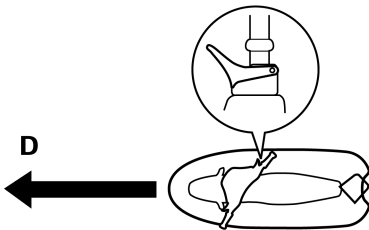

## You need throttle to steer.

This model is equipped with the Yamaha Engine Management System (YEMS) that includes an off-throttle steering (OTS) system. It will activate at planing speeds should you attempt to steer the watercraft after releasing the throttle lever (see condition C above).

The OTS system assists in turning by continuing to supply some thrust while the watercraft is decelerating, but you can turn more sharply

if you apply throttle while turning the handlebars. The OTS system does not function below planing speeds or when the engine is off. Once the engine slows down, the watercraft will no longer turn in response to handlebar input until you apply throttle again or you reach trolling speed.

EJU33292

## Stopping the watercraft

The watercraft is not equipped with a separate braking system. It is stopped by water resistance when the throttle lever is released. From full speed, the watercraft comes to a complete stop in approximately 100 m (330 ft) after the throttle lever is released or the engine is stopped, although this distance will vary depending on many factors, including gross weight, water surface conditions, and wind direction. The watercraft slows down as soon as the throttle lever is released, but will coast for a distance before fully stopping. If you are not sure you can stop in time before hitting an obstacle, apply throttle and turn in another direction.

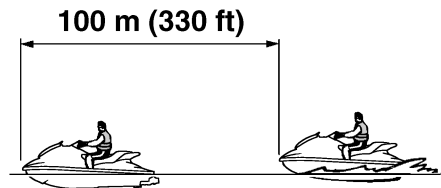

EWJ00742

## ⚠ WARNING

- Allow adequate stopping distance.
- Take early action to avoid collisions. Remember, watercraft and other boats do not have brakes.
- Operate defensively at safe speeds and keep a safe distance away from people,

objects, and other watercraft to give you time to stop.

- Do not shut the engine off when slowing down in case you need engine power to steer away from a boat or other obstacle that comes into your path.
- Do not use the reverse function to slow down or stop the watercraft as it could cause you to lose control, be ejected, or impact the handlebars.

EJU40371

## Operating the watercraft in reverse

Pull the shift lever rearward to the reverse position. The watercraft will move in reverse. (See page 32 for information on the reverse system.)

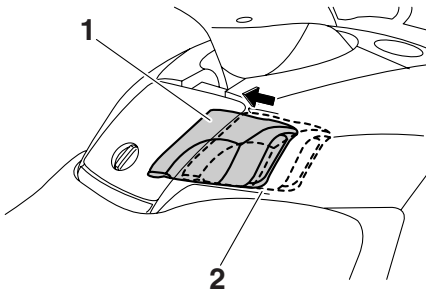

- 1 Shift lever
- 2 Reverse position



Make sure that there are no obstacles or people behind you before shifting into reverse.

## TIP:

This model is equipped with a function which limits the engine speed in reverse.

EJU36083

## Boarding the watercraft

EWJ01111

## ⚠ WARNING

Be sure the operator and any passengers have practiced boarding from the water while still close to shore before riding. A person who has made many unsuccessful attempts to get back on the watercraft may become fatigued and suffer from exposure, increasing the risk of injury and drowning.

Board the watercraft in water free from weeds and debris and at least 60 cm (2 ft) deep from the bottom of the watercraft. **NOTICE:** Never run the engine in water that is less than 60 cm (2 ft) deep from the bottom of the watercraft, otherwise pebbles or sand could be sucked into the jet intake, causing impeller damage and engine overheating.

[ECJ00472]

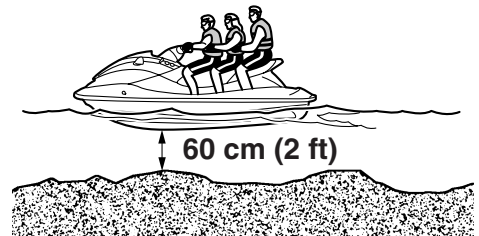

## TIP:

This watercraft is equipped with a reboarding step, which can be lowered and used to make reboarding easier. (See page 48 for information on operating the reboarding step.)

# Operation

---

EJU36353

## Boarding alone

- (1) From the rear of the watercraft, place both hands on the boarding platform, pull yourself up, and then grasp the handgrip with one hand.

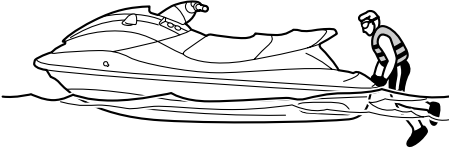

- (2) Pull yourself up to a kneeling position on the boarding platform, and then move to the seat and sit astride.

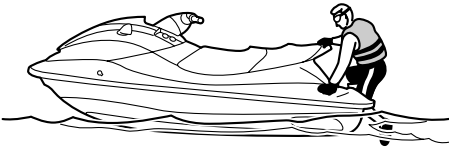

- (3) Attach the engine shut-off cord (lanyard) to your left wrist, and then attach the clip to the engine shut-off switch.

- (4) Grip the handlebars with both hands and place both feet on the floor of the footwell.



- (5) Look in all directions, start the engine, and then start off slowly.

EJU33169

## Boarding with passenger(s)

EWJ00660

### **WARNING**

**Severe internal injuries can occur if water is forced into body cavities as a result of being near the jet thrust nozzle. Do not apply throttle until the passengers are seated with their feet on the floor of the footwell and are securely holding on to the person in front of them or to the handgrip provided.**

The heavier the total weight of the operator and passenger(s), the more difficult it will be to balance the watercraft. Do not operate the watercraft when the total weight exceeds 240 kg (530 lb) including any cargo.

## To board at a standstill:

- (1) Board as noted in the previous section "Boarding alone".

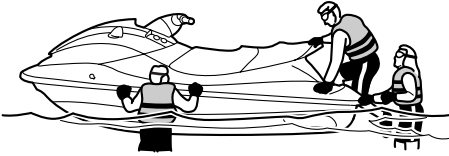

- (2) Attach the engine shut-off cord (lanyard) to your left wrist, and then attach the clip to the engine shut-off switch.
- (3) Grip the handlebars with both hands and place both feet on the floor of the footwell.
- (4) Have the first passenger move to the rear of the watercraft.

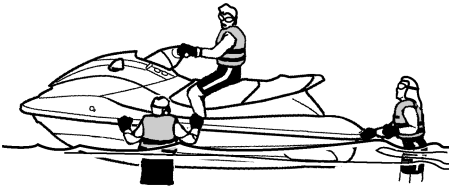

- (5) Have the first passenger board using the same procedure as the operator, place

their feet on the floor of the footwell, and securely hold on to the operator.

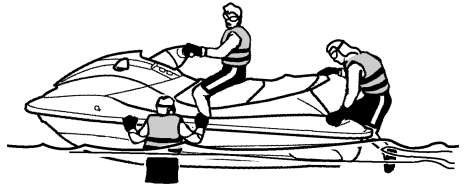

- (6) Have the second passenger follow the same procedure. When the second passenger is boarding, try to balance the watercraft together with the first passenger.



- (7) Make sure that the passenger(s) have their feet on the floor of the footwell and are securely holding on to the person in front of them or to the handgrip provided.



# Operation

---

- (8) Look in all directions, start the engine, and then start off slowly.

To board when it is difficult to balance at a standstill:

- (1) Have the passenger(s) steady the watercraft, and then board as noted in the previous section "Boarding alone".

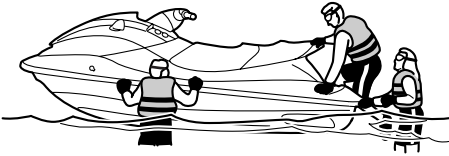

- (2) Grip the handlebars with both hands, place both feet on the floor of the footwell, and balance there.
- (3) Have the first passenger board using the same procedure as the operator, place their feet on the floor of the footwell, securely hold on to the operator, and balance there.
- (4) Attach the engine shut-off cord (lanyard) to your left wrist, and then attach the clip to the engine shut-off switch.
- (5) Look in all directions, and then start the engine and operate at trolling speed.
- (6) Have the second passenger pull themselves up onto the boarding platform into a kneeling position and balance there. Look in all directions, and then gradually accelerate. Then, have the second pas-

senger crawl onto the seat while maintaining their balance.



- (7) Have the second passenger sit astride the seat, place their feet on the floor of the footwell, securely hold on to the person in front of them or to the handgrip provided, and balance there.
- (8) Make sure that the passenger(s) have their feet on the floor of the footwell and are securely holding on to the person in front of them or to the handgrip provided, and then gradually increase the speed to balance the watercraft.



EJU33082

## Starting off

EWJ00711



**To avoid collisions:**

- Scan constantly for people, objects, and other watercraft. Be alert for conditions that limit your visibility or block your vision of others.

- Operate defensively at safe speeds and keep a safe distance away from people, objects, and other watercraft.
- Do not follow directly behind watercraft or other boats. Do not go near others to spray or splash them with water. Avoid sharp turns or other maneuvers that make it hard for others to avoid you or understand where you are going. Avoid areas with submerged objects or shallow water.
- Take early action to avoid collisions. Remember, watercraft and other boats do not have brakes. Do not release the throttle lever when trying to steer away from objects—you need throttle to steer.

ECJ01340

## NOTICE

Never run the engine in water that is less than 60 cm (2 ft) deep from the bottom of the watercraft, otherwise pebbles or sand could be sucked into the jet intake, causing impeller damage and engine overheating.

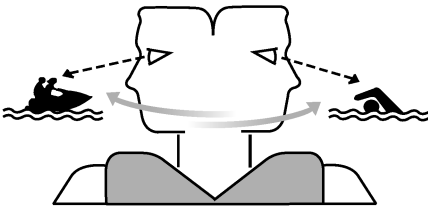

EJU40232

## Starting off from a trailer

- (1) Launch the watercraft and move the shift lever to the reverse position. (See page 32 for information on the reverse system.)

- (2) Attach the engine shut-off cord (lanyard) to your left wrist, and then attach the clip to the engine shut-off switch.
- (3) Look in all directions, start the engine, and then start off slowly.

EJU33113

## Boarding and starting off from a dock

- (1) Board the watercraft from the side.
- (2) Attach the engine shut-off cord (lanyard) to your left wrist, and then attach the clip to the engine shut-off switch.
- (3) Push the watercraft away from the dock, grip the handlebars with both hands, and place both feet on the floor of the footwell.

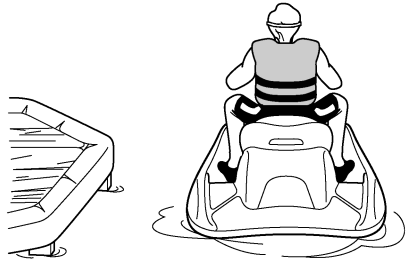

- (4) Look in all directions, start the engine, and then start off slowly.

EJU33234

## Capsized watercraft

EWJ00671

## ⚠ WARNING

Improper uprighting can cause injury.

- Be sure to shut the engine off by pulling on the engine shut-off cord (lanyard) to remove the clip from the engine shut-off switch.
- Do not put your hands in the intake grate.

If the watercraft capsizes, turn it over immediately.

## To upright the watercraft:

- (1) Remove the clip from the engine shut-off switch.

# Operation

- (2) Swim to the rear of the watercraft. Turn the watercraft over clockwise by pulling on the ride plate with your left hand while pushing down on the gunwale with your right hand or foot.

If the port (left) side of the capsized watercraft is tilting up, push down on the gunwale so that the port (left) side is down before turning the watercraft clockwise. **NOTICE: Do not turn the watercraft over counterclockwise, otherwise water can enter the engine, which can result in severe damage.**

[ECJ00541]



- (3) Start the engine and operate the watercraft at planing speed to drain water in the engine compartment. (See page 57 for information on draining the bilge water. If the engine does not start, see “Towing the watercraft” on page 100 or “Submerged watercraft” on page 100.)

**NOTICE: Do not run the engine at full throttle for at least 1 minute after the engine has been restarted. Bilge water in the engine compartment can splash into the engine, which can result in severe damage.** [ECJ00553]

EJU35962

## Beaching and docking the watercraft

### To beach the watercraft:

- (1) Make sure that there are no boats, swimmers, or obstacles near the beach.
- (2) Release the throttle lever to reduce speed about 100 m (330 ft) before you reach the intended beaching area.
- (3) Slowly approach the beach and stop the engine just before reaching land. **WARNING! You need throttle to steer. Shutting the engine off can cause you to hit an obstacle you are attempting to avoid. A collision could result in severe injury or death.** [EWJ00601] **NOTICE: Never run the engine in water that is less than 60 cm (2 ft) deep from the bottom of the watercraft, otherwise pebbles or sand could be sucked into the jet intake, causing impeller damage and engine overheating.** [ECJ00472]
- (4) Get off the watercraft and pull it up on the beach.

### To dock the watercraft:

- (1) Make sure that there are no boats, swimmers, or obstacles near the dock.
- (2) Release the throttle lever to reduce speed about 100 m (330 ft) away from the dock.
- (3) Slowly approach the dock and stop the engine just before coming alongside it. **WARNING! You need throttle to steer. Shutting the engine off can cause you to hit an obstacle you are attempting to avoid. A collision could result in severe injury or death.** [EWJ00601]



- (4) Come alongside the dock and get off the watercraft.

EJU37193

## Operating in weeded areas

Always avoid using your watercraft in areas where weed growth is thick. If operating in weeded areas is unavoidable, alternately squeeze the throttle lever and relax your grip on the throttle lever to vary the engine speed. Weeds tend to become clogged more when operating at a steady speed and at trolling speed. If weeds may have clogged the intake area, clean the jet intake. (See page 97 for information on the jet intake.)

EJU40241

## After removing the watercraft from the water

ECJ01310

### **NOTICE**

**Do not run the engine over 4000 r/min on land. Also, do not run the engine for more than 15 seconds without supplying water, otherwise the engine could overheat.**

After operating and removing the watercraft from the water, promptly discharge the remaining water from the cooling water passages.

To discharge water from the cooling water passages:

- (1) Make sure that the area around the watercraft is clear, and then start the engine.
- (2) Discharge the remaining water out of the cooling water passages by alternately squeezing and releasing the throttle lever quickly for 10 to 15 seconds.
- (3) Stop the engine.

# Care and storage

EJU37145

## Post-operation care

EWJ00330

### **WARNING**

Always place the watercraft upright in a horizontal position when storing it, otherwise fuel could leak out into the engine or engine compartment, which could create a fire hazard.

After using the watercraft, always take it out of the water, clean it, and store it. Leaving the watercraft in the water for extended periods will accelerate the rate of normal deterioration of the jet pump and hull. Marine organisms and corrosion are some of the conditions that can shorten the life of many watercraft components.

EJU33539

## Flushing the cooling water passages

ECJ01310

### **NOTICE**

Do not run the engine over 4000 r/min on land. Also, do not run the engine for more than 15 seconds without supplying water, otherwise the engine could overheat.

Flush the cooling water passages to prevent them from clogging with salt, sand, or dirt.

- (1) Place the watercraft in a horizontal position.
- (2) Remove the seats and seat storage compartment. (See page 47 for seat removal and installation procedures and page 52 for information on the seat storage compartment.)

- (3) Connect the garden hose adapter to a garden hose.



1 Garden hose adapter

- (4) Loosen the flushing hose connector cap and remove it. Insert the garden hose adapter into the flushing hose connector and turn it until it is securely connected.

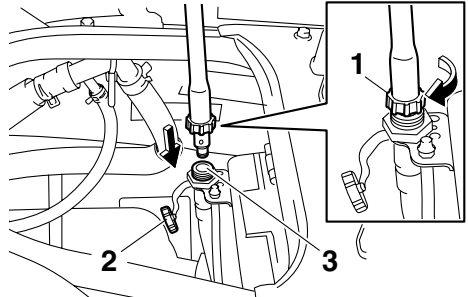

1 Garden hose adapter

2 Flushing hose connector cap

3 Flushing hose connector

- (5) Connect the garden hose to a water tap.
- (6) Make sure that the area around the watercraft is clear, and then start the engine. Immediately after the engine starts, fully turn the water supply on so that water

flows out continually from the jet thrust nozzle.

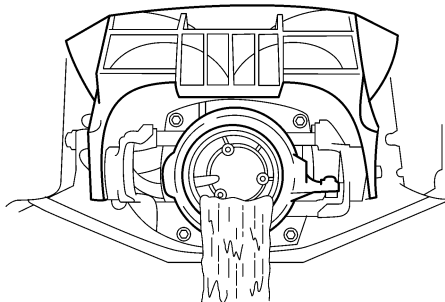

- (7) Run the engine at idling speed for about 3 minutes watching the engine condition. If the engine stops while flushing, turn the water supply off immediately and perform the procedure again from step 6. **NOTICE: Do not supply water to the cooling water passages when the engine is not running. The water could flow back through the muffler into the engine, causing severe engine damage.** [ECJ00122]
- (8) Turn the water supply off.
- (9) Discharge the remaining water out of the cooling water passages by alternately squeezing and releasing the throttle lever quickly for 10 to 15 seconds.
- (10) Stop the engine.
- (11) Remove the garden hose adapter, and then securely install the flushing hose connector cap by tightening it until it stops.
- (12) Securely install the seat storage compartment and seats in their original positions.

EJU33735

## Cleaning the watercraft

- (1) Remove the seats. (See page 47 for seat removal and installation procedures.)
- (2) Rinse the engine and engine compartment with a small amount of water. **NOTICE: Do not use high-pressure**

**water when rinsing the engine or engine compartment as severe engine damage could result.** [ECJ00571]

- (3) Drain the water from the engine compartment. (See page 57 for information on draining the bilge water.)
- (4) Wipe the engine and engine compartment with a dry cloth.
- (5) Wash down the hull, deck, and jet pump with fresh water.
- (6) Wipe the hull, deck, and jet pump with a dry cloth.
- (7) Wipe all vinyl and rubber components, such as the seats and engine compartment seals, with a vinyl protectant.
- (8) To minimize corrosion, spray metallic parts of the hull, deck, and engine with a rust inhibitor.
- (9) Allow the engine compartment to air dry completely before installing the seats.
- (10) Securely install the seats in their original positions.

EJU33686

## Battery care

If the watercraft will not be used for more than a month, remove the battery from the watercraft, check it, and then store it in a cool, dry place.

EWJ00791

## WARNING

**Battery electrolyte is poisonous and dangerous, causing severe burns, etc. Electrolyte contains sulfuric acid. Avoid contact with skin, eyes, or clothing.**

### Antidotes

**External: Flush with water.**

**Internal: Drink large quantities of water or milk. Follow with milk of magnesia, beaten egg, or vegetable oil. Call a physician immediately.**

**Eyes: Flush with water for 15 minutes and get prompt medical attention.**

# Care and storage

Batteries produce explosive gases. Keep sparks, flames, cigarettes, etc., well away. If using or charging the battery in an enclosed space, make sure that it is well ventilated. Always shield your eyes when working near batteries. Keep out of the reach of children.

## To remove the battery:

- (1) Disconnect the negative (-) battery lead.
- (2) Disconnect the positive (+) battery lead.
- (3) Disconnect the breather hose.
- (4) Unhook the battery bands, and then remove the battery from the watercraft.

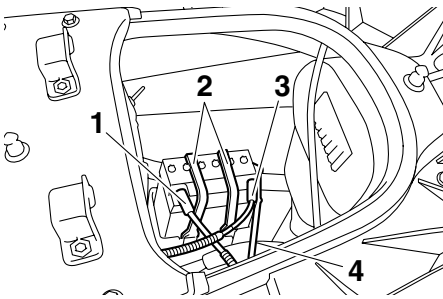

- 1 Negative (-) battery terminal: Black lead
- 2 Battery band
- 3 Positive (+) battery terminal: Red lead
- 4 Breather hose

## Checking the battery

- Make sure that the battery case is not damaged.
- Make sure that the battery terminals are not corroded or damaged.
- Make sure that the breather hose is not clogged or damaged.

## Checking the electrolyte level

Make sure that the electrolyte level is between the maximum and minimum level marks.

If the electrolyte level is low, add distilled water to raise it to the specified level. **NOTICE:** Use only distilled water for replenishing

the battery, otherwise battery life could be shortened. [ECJ00241]

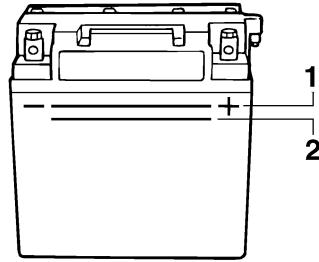

- 1 Maximum level mark
- 2 Minimum level mark

If distilled water was added, check the battery voltage.

It is recommended to have a Yamaha dealer check the battery voltage and charge the battery. If you charge the battery yourself, be sure to read and follow the instructions provided with the battery tester and charger you use. **NOTICE:** Do not attempt to charge a battery hastily. Battery life could be shortened. [ECJ00251]

## Checking the battery bands

Make sure that the battery bands are not damaged.

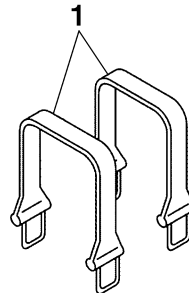

- 1 Battery band

## To store the battery:

- (1) Clean the battery case using fresh water.

# Care and storage

- (2) If the battery terminals are dirty or corroded, clean them using a wire brush.
- (5) Make sure that the battery is securely held in place.

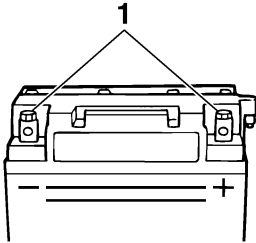

1 Battery terminal

- (3) Apply Yamaha Marine Grease or Yamaha Grease A to the battery terminals.

Recommended water-resistant grease:  
Yamaha Marine Grease/Yamaha  
Grease A

- (4) Store the battery in a cool, dry place.  
**NOTICE: Storing the battery in an uncharged condition can cause permanent battery damage. Check the battery periodically.** [ECJ00102]

## To install the battery:

- (1) Place the battery in the battery compartment and hook the battery bands onto the holders.
- (2) Connect the positive (+) battery lead (red) to the positive (+) battery terminal.  
**NOTICE: Reversal of the battery leads will damage the electrical parts.** [ECJ00261]
- (3) Connect the negative (-) battery lead (black) to the negative (-) battery terminal.
- (4) Connect the breather hose to the battery.  
**WARNING! Fire or explosion could result if the breather hose is damaged, obstructed, or not connected properly.** [EWJ00451]

# Care and storage

EJU33492

## Long-term storage

EWJ00330

### **WARNING**

**Always place the watercraft upright in a horizontal position when storing it, otherwise fuel could leak out into the engine or engine compartment, which could create a fire hazard.**

Storage for long periods of time, such as winter storage, requires preventive maintenance to ensure against deterioration. It is advisable to have the watercraft serviced by a Yamaha dealer prior to storage.

However, the following procedures can be performed easily by the owner.

EJU40762

### **Cleaning**

- (1) Flush the cooling water passages. (See page 83 for information on flushing the cooling water passages.)

### **TIP:**

If you will be storing the watercraft for a prolonged period, such as winter storage, top off the fuel tank with fresh gasoline and add fuel stabilizer and conditioner to the fuel tank according to the manufacturer's instruction before starting the engine.

- (2) Clean the watercraft. (See page 84 for information on cleaning the watercraft.)

Wax the hull with a non-abrasive wax.

EJU36914

### **Lubrication**

Use a suitable marine grease applicator and spray a rust inhibitor between the inner and outer cables to lubricate the cables and purge out any dirt and moisture.

To keep moving parts sliding or rotating smoothly, lubricate them with water-resistant grease.

Recommended water-resistant grease:  
Yamaha Marine Grease/Yamaha Grease A

- Throttle cable (throttle lever end)

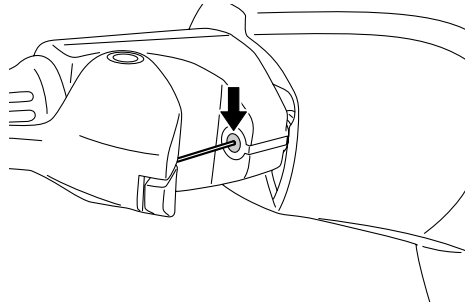

- Steering cable (jet thrust nozzle end) and Q.S.T.S. rod (jet thrust nozzle end)

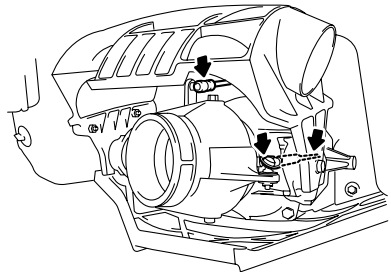

- Shift cable (shift lever end)

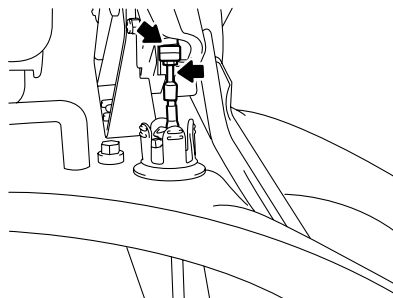

- Shift cable (reverse gate end)

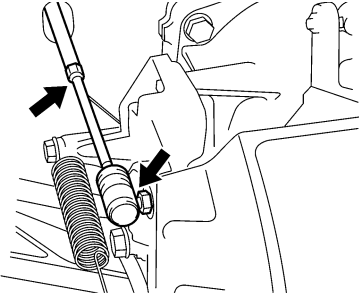

EJU40811

## **Rustproofing**

Spray metallic parts of the hull, deck, and engine with a rust inhibitor.

Have a Yamaha dealer rustproof the internal engine components.

# Maintenance

EJU33768

## Maintenance

Periodic checks and lubrication will keep your watercraft in the safest and most efficient condition possible. Therefore, make sure to carry out the periodic maintenance. Safety is an obligation of the watercraft owner. Proper maintenance must be carried out to keep the exhaust emission and sound levels within the regulated limits. The most important points of watercraft inspection and lubrication are explained on the following pages.

See a Yamaha dealer for genuine Yamaha replacement parts and optional accessories designed for your watercraft.

Remember, failures that are the result of the installation of parts or accessories which are not qualitatively equivalent to genuine Yamaha parts are not covered by the limited warranty.

**Maintenance, replacement, or repair of the emission control devices and system may be performed by any marine SI engine repair establishment or individual. Warranty repair, however, must be performed at an authorized Yamaha marine dealership.**

EWJ00311

### **WARNING**

**Be sure to turn off the engine when you perform maintenance unless otherwise specified. If you are not familiar with machine servicing, this work should be done by a Yamaha dealer or other qualified mechanic.**

EJU33802

### Tool kit

A tool kit is included with this watercraft. Place the tool kit in a waterproof bag and always

carry it with you whenever you use the watercraft.

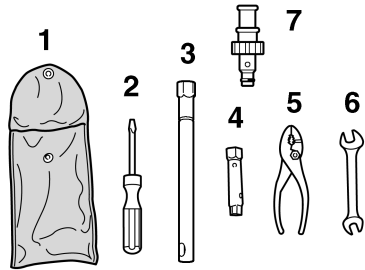

- 1 Tool bag
- 2 Screwdriver
- 3 16 mm box wrench
- 4 10/12 mm box wrench
- 5 Pliers
- 6 Open-end wrench
- 7 Garden hose adapter

EJU40432

## Removing and installing the engine cover

The engine cover is removable.

To remove the engine cover:

- (1) Remove the seats. (See page 47 for seat removal and installation procedures.)
- (2) Remove the engine cover screws.

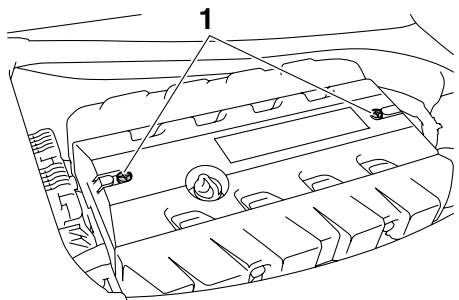

- 1 Engine cover screw



- (3) Slide the engine cover toward the stern, and then lift up the cover to remove it.

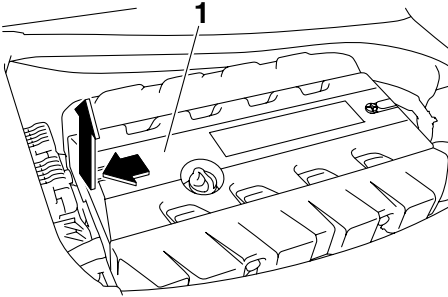

1 Engine cover

To install the engine cover:

- (1) Place the engine cover in its original position, push it down, and then slide it toward the bow.

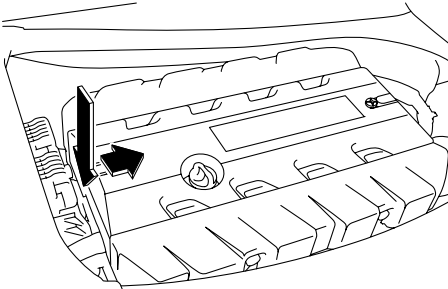

- (2) Install the engine cover screws, and then tighten them to the specified torque.

Tightening torque:

Engine cover screw:

4.5 Nm (0.46 kgf-m, 3.3 ft-lb)

- (3) Securely install the seats in their original positions.

# Maintenance

EJU37062

## Periodic maintenance chart

The periodic maintenance chart gives general guidelines for periodic maintenance. Have a Yamaha dealer perform the checks in the following chart. However, maintenance may need to be performed more frequently depending on your operating conditions. If you have any questions, consult a Yamaha dealer.

This “○” mark indicates items to be checked and serviced by a Yamaha dealer.

Item	Operation	Initial	Thereafter every				Page
		10 hours	50 hours		100 hours	200 hours	
			6 months	12 months	12 months	24 months	
<b>Spark plugs</b>	Check, clean, replace	○			○		—
<b>Lubrication points</b>	Lubricate				○		—
<b>Internal engine components</b>	Spray lubricant			○			—
<b>Intermediate housing</b>	Lubricate	○			○		—
<b>Fuel system</b>	Check				○		—
<b>Fuel tank</b>	Check, clean				○		—
<b>Engine idling speed</b>	Check, adjust				○		—
<b>Throttle shaft</b>	Check				○		—
<b>Water inlet strainer</b>	Check, clean				○		—
<b>Bilge strainer</b>	Clean				○		—
<b>Electric bilge pump strainer</b>	Clean				○		—
<b>Impeller</b>	Check				○		—
<b>Jet thrust nozzle angle</b>	Check, adjust				○		—
<b>Steering master</b>	Check, adjust	○			○		—
<b>Q.S.T.S. mechanism</b>	Check, adjust	○			○		—
<b>Shift cable and reverse gate</b>	Check, adjust				○		—
<b>Throttle cable</b>	Check	○			○		—
<b>Stern drain plugs</b>	Check, replace				○		—
<b>Battery</b>	Check, charge				○		—
<b>Rubber coupling</b>	Check					○	—

Item	Operation	Initial	Thereafter every				Page
		10 hours	50 hours		100 hours	200 hours	
			6 months	12 months	12 months	24 months	
Engine mount	Check					○	—
Nuts and bolts	Check	○			○		—
Air filter element	Check				○		—
Engine oil	Replace	○		○			92
Oil filter	Replace				○		92
Valve clearance	Check, adjust					○	—

EJU36942

## Engine oil and oil filter

EWJ00340



### WARNING

Engine oil is extremely hot immediately after the engine is turned off. Coming in contact with or getting any engine oil on your clothes could result in burns.

ECJ00991

### NOTICE

Do not run the engine with too much or not enough oil in the engine, otherwise the engine could be damaged.

It is recommended to have a Yamaha dealer change the engine oil and the engine oil filter. However, if you choose to change the oil and filter on your own, consult a Yamaha dealer.

# Specifications

---

EJU34542

## Specifications

### Watercraft capacity:

Maximum people on board:

3 person

Maximum load capacity:

240 kg (530 lb)

### Dimensions:

Length:

3370 mm (132.7 in)

Width:

1230 mm (48.4 in)

Height:

FX SHO 1160 mm (45.7 in)

FX Cruiser SHO 1240 mm (48.8 in)

Dry weight:

FX SHO 376 kg (829 lb)

FX Cruiser SHO 381 kg (840 lb)

### Performance:

Maximum output (according to ISO 8665/SAE

J1228):

154.5 kW@7500 r/min

Maximum fuel consumption:

63.7 L/h (16.8 US gal/h, 14.0 Imp.gal/h)

Cruising range at full throttle:

1.10 hour

Trolling speed:

1250 ±100 r/min

### Engine:

Engine type:

Liquid cooled 4-stroke, DOHC

Number of cylinders:

4

Engine displacement:

1812 cm<sup>3</sup>

Bore & stroke:

86.0 × 78.0 mm (3.39 × 3.07 in)

Compression ratio:

8.6 : 1

Valve clearance-intake (cold):

0.14–0.23 mm (0.0055–0.0091 in)

Valve clearance-exhaust (cold):

0.28–0.37 mm (0.0110–0.0146 in)

Lubrication system:

Wet sump

Cooling system:

Water

Starting system:

Electric

Ignition system:

T.C.I.

Spark plug:

LFR6A

Spark plug gap:

0.8–0.9 mm (0.031–0.035 in)

Battery capacity:

12 V, 19.0 Ah

Charging system:

Flywheel magneto

### Drive unit:

Propulsion system:

Jet pump

Jet pump type:

Axial flow, single stage

Impeller rotation:

Counterclockwise

Jet thrust nozzle angle:

24.0+24.0 °

Jet thrust nozzle trim angle:

-10, -5, 0, 5, 10 °

### Fuel and oil:

Recommended fuel:

Regular unleaded gasoline

Minimum octane rating (PON):

86

Minimum octane rating (RON):

90

Recommended engine oil type SAE:

SAE 10W-30, 10W-40, 20W-40, 20W-50

Recommended engine oil grade API:

API SE,SF,SG,SH,SJ,SL

Fuel tank total capacity:

70 L (18.5 US gal, 15.4 Imp.gal)

Engine oil quantity with oil filter replacement:

3.1 L (3.28 US qt, 2.73 Imp.qt)

Engine oil quantity without oil filter replacement:

3.0 L (3.17 US qt, 2.64 Imp.qt)

Engine oil total quantity:

4.3 L (4.55 US qt, 3.78 Imp.qt)

# Trouble recovery

EJU34561

## Troubleshooting

If you have any trouble with your watercraft, use the troubleshooting chart to check for the possible cause.

If you cannot find the cause, consult a Yamaha dealer.

EJU36984

### Troubleshooting chart

Confirm the possible cause and remedy, and then refer to the applicable page.

TROUBLE	POSSIBLE CAUSE		REMEDY	PAGE
<b>Engine does not start (Starter motor does not turn over)</b>	Yamaha Security System	Lock mode selected	Select unlock mode	27
	Engine shut-off switch	Clip not in place	Install clip	28
	Fuse	Burned out	Replace fuse and check wiring	98
	Battery	Run down	Recharge	84
		Poor terminal connections	Tighten as required	84
		Terminal corroded	Clean or replace	84
	Starter motor	Faulty	Have serviced by Yamaha dealer	—
<b>Engine does not start (Starter motor turns over)</b>	Throttle lever	Squeezed	Release	28
	Fuel	Empty	Refill as soon as possible	54
		Stale or contaminated	Have serviced by Yamaha dealer	—
	Fuel tank	Water or dirt present	Have serviced by Yamaha dealer	—
	Spark plug	Fouled or defective	Have serviced by Yamaha dealer	—
	Spark plug cap	Not connected or loose	Have serviced by Yamaha dealer	—
		Connected to wrong cylinder	Have serviced by Yamaha dealer	—
	Fuel injection system	Fuel pump faulty	Have serviced by Yamaha dealer	—

# Trouble recovery

TROUBLE	POSSIBLE CAUSE		REMEDY	PAGE
<b>Engine runs irregularly or stalls</b>	Fuel	Empty	Refill as soon as possible	54
		Stale or contaminated	Have serviced by Yamaha dealer	—
	Fuel tank	Water or dirt present	Have serviced by Yamaha dealer	—
	Spark plug	Fouled or defective	Have serviced by Yamaha dealer	—
		Incorrect heat range	Have serviced by Yamaha dealer	—
		Gap incorrect	Have serviced by Yamaha dealer	—
	Spark plug cap	Not connected or loose	Have serviced by Yamaha dealer	—
		Cracked, torn, or damaged	Have serviced by Yamaha dealer	—
	Electrical wiring	Loose connection	Have serviced by Yamaha dealer	—
	Fuel injection system	Faulty or clogged injectors	Have serviced by Yamaha dealer	—
<b>Warning light or indicator blinks or comes on</b>	Fuel level	Empty	Refill as soon as possible	54
	Oil pressure warning	Oil pressure dropped	Have serviced by Yamaha dealer	43
	Engine overheated	Jet intake clogged	Clean	97
	Check engine warning	Faulty sensors	Have serviced by Yamaha dealer	44

# Trouble recovery

TROUBLE	POSSIBLE CAUSE		REMEDY	PAGE
<b>Watercraft slow or loses power</b>	Shift lever	Not completely shifted into forward position	Push lever forward until it stops	32
	Watercraft operation mode	Low RPM Mode activated	Deactivate Low RPM Mode	34
	Cavitation	Jet intake clogged	Clean	97
		Impeller damaged or worn	Have serviced by Yamaha dealer	97
	Engine over-heat warning	Engine speed reduction control activated	Clean jet intake and cool engine	43
	Oil pressure warning	Engine speed reduction control activated	Add oil	43
	Spark plug	Fouled or defective	Have serviced by Yamaha dealer	—
		Incorrect heat range	Have serviced by Yamaha dealer	—
		Gap incorrect	Have serviced by Yamaha dealer	—
	Spark plug cap	Not connected or loose	Have serviced by Yamaha dealer	—
	Electrical wiring	Loose connection	Have serviced by Yamaha dealer	—
	Fuel	Stale or contaminated	Have serviced by Yamaha dealer	—
	Air filter	Clogged	Have serviced by Yamaha dealer	—
Oil buildup		Have serviced by Yamaha dealer	—	

# Trouble recovery

EJU34622

## Emergency procedures

EJU34634

### Cleaning the jet intake and impeller

EWJ00782

#### **WARNING**

Before attempting to remove weeds or debris from the jet intake or impeller area, shut the engine off and remove the clip from the engine shut-off switch. Severe injury or death could result from coming in contact with the rotating parts of the jet pump.

If weeds or debris gets caught in the jet intake or impeller, cavitation can occur, causing jet thrust to decrease even though engine speed rises. If this condition is allowed to continue, the engine will overheat and may seize. **NOTICE:** If weeds or debris gets caught in the jet intake, do not operate the watercraft above trolling speed until they have been removed. [ECJ00653]

If there is any sign that the jet intake or impeller is clogged with weeds or debris, return to shore and check the intake and impeller. Al-

ways stop the engine before beaching the watercraft.

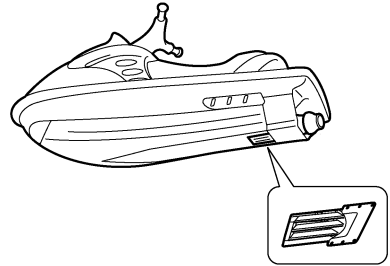
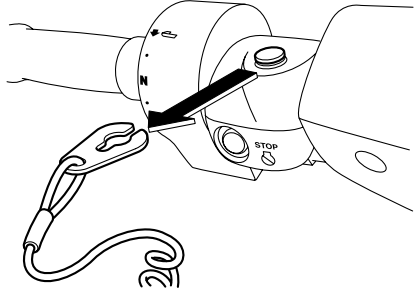

- (1) Place a suitable clean cloth or carpeting underneath the watercraft to protect it from abrasions and scratches. Turn the watercraft on its side as shown. **NOTICE:** Always turn the watercraft over onto its port (left) side. When turning the watercraft on its side, support the bow so that the handlebars are not bent or damaged. [ECJ00661]

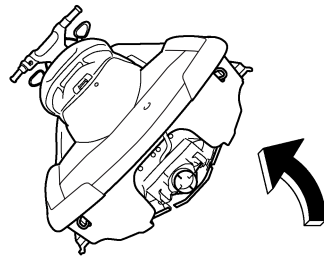



# Trouble recovery

- (2) Remove any weeds or debris from around the jet intake, drive shaft, impeller, jet pump housing, and jet thrust nozzle.

If debris is difficult to remove, consult a Yamaha dealer.

EJU34641

## Jumping the battery

If the watercraft battery has run down, the engine can be started using a 12-volt booster battery and jumper cables.

EJU34663

## Connecting the jumper cables

EWJ01250



### WARNING

To avoid battery explosion and serious damage to the electrical system:

- Do not reverse the polarity of the jumper cables when connecting to the batteries.
- Do not connect the negative (-) jumper cable to the negative (-) terminal of the watercraft battery.
- Do not touch the positive (+) jumper cable to the negative (-) jumper cable.

- (1) Connect the positive (+) jumper cable to the positive (+) battery terminals of both batteries.
- (2) Connect one end of the negative (-) jumper cable to the negative (-) battery terminal of the booster battery.

- (3) Connect the other end of the negative (-) jumper cable to an engine hanger.

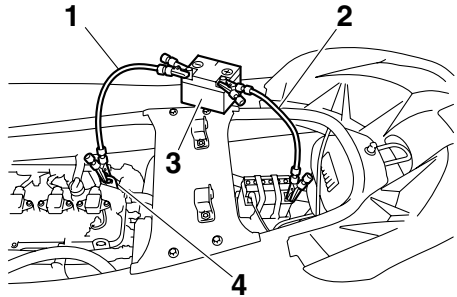

- 1 Negative (-) jumper cable
- 2 Positive (+) jumper cable
- 3 Booster battery
- 4 Engine hanger

- (4) Start the engine, and then disconnect the jumper cables by reversing the steps above. (See page 28 for information on starting the engine.)

EJU36994

## Replacing the fuses

If a fuse is blown, replace it with the proper fuse.

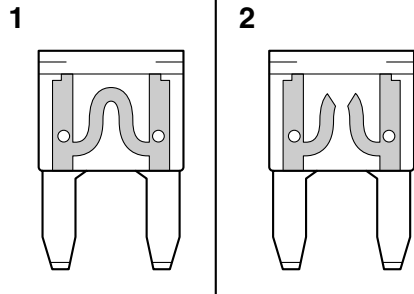

- 1 Good fuse
- 2 Blown fuse

To replace a fuse:

- (1) Remove the seats. (See page 47 for seat removal and installation procedures.)

# Trouble recovery

- (2) Remove the electrical box cover.

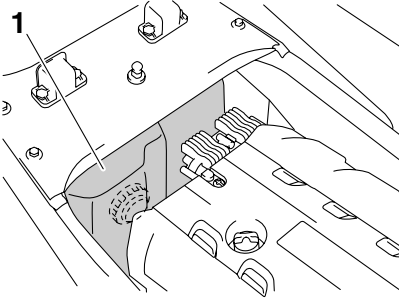

1 Electrical box cover

- (3) Loosen the cap on the electrical box and remove it.  
(4) Replace the blown fuse with the spare fuse of the correct amperage by using the fuse puller on the reverse side of the cap.

**WARNING! Do not use fuses of a different amperage than recommended. Substitution with a fuse that has an improper rating can cause extensive**

**electrical system damage and possible fire.** [EWJ00802]

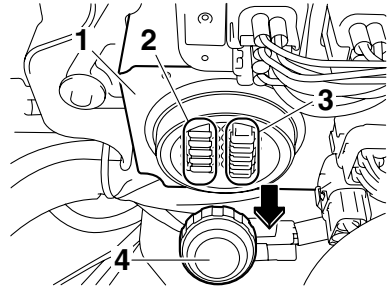

- 1 Electrical box  
2 Spare fuse  
3 Fuse  
4 Cap

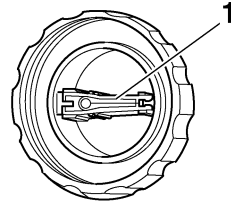

1 Fuse puller

Fuse amperage:

Battery fuse:

30 A

Main relay drive fuse:

10 A

Electronic throttle valve fuse:

10 A

Security system fuse:

3 A

Main fuse:

20 A

- (5) Securely install the cap by tightening it until it stops.  
(6) Securely install the electrical box cover in its original position.

- (7) Securely install the seats in their original positions.

If the fuse immediately blows again, the electrical system may be defective. If this occurs, have a Yamaha dealer service the watercraft.

EJU34714

## Towing the watercraft

EWJ00811

### WARNING

- The operator of the towing boat must keep speed to a minimum and avoid traffic or obstacles which could be a hazard to the operator on the watercraft.
- The towline should be long enough so that the watercraft will not collide with the towing boat when slowing down.

If the watercraft becomes inoperative in the water, it can be towed to shore.

#### To tow the watercraft:

Use a towline that is three times the combined length of the towing boat and the watercraft.

- (1) Securely attach the towline to the bow eye of the watercraft being towed.

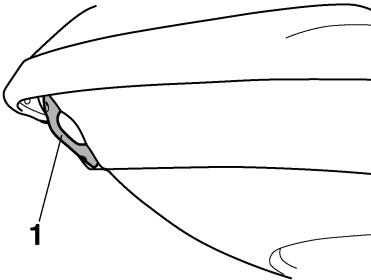

1 Bow eye

- (2) Sit astride the seat and hold on to the handlebars in order to balance the watercraft. **NOTICE: The bow must be kept up out of the water during towing, otherwise water could flood the engine compartment or water could flow back**

**into the engine, causing severe engine damage.** [ECJ01330]

Tow the watercraft at 8 km/h (5 mph) or less.

**NOTICE: Tow the watercraft at 5 km/h (5 mph) or less, otherwise water could flood the engine compartment or water could flow back into the engine, causing severe engine damage.** [ECJ01320]

EJU36154

## Submerged watercraft

If the watercraft is submerged or flooded with water, drain the water from the engine compartment. Then, have a Yamaha dealer service the watercraft as soon as possible.

If the watercraft was submerged:

- (1) Remove the watercraft from the water and drain the water from the storage compartments. (See page 50 for information on draining the storage compartments.)
- (2) Drain the water from the engine compartment. (See page 57 for information on draining the bilge water.)
- (3) Have the watercraft serviced by a Yamaha dealer as soon as possible.

**NOTICE: Be sure to have a Yamaha dealer inspect the watercraft. Otherwise, serious engine damage could result.** [ECJ00791]

# Index

---

<b>A</b>			
Adjustable tilt steering system.....	30	Engine oil requirements .....	56
Adjustable tilt steering system checks .....	65	Engine overheat warning .....	43
After removing the watercraft from the water.....	82	Engine serial number .....	1
Analog speedometer/tachometer.....	39	Engine shut-off cord (lanyard) check .....	67
<b>B</b>		Engine shut-off switch .....	28
Battery care.....	84	Engine stop switch .....	28
Battery checks.....	64	Engine unit check.....	64
Battery, jumping .....	98	Enjoy your watercraft responsibly .....	19
Beaching and docking the watercraft.....	81	Equipment .....	47
Beverage holder.....	53	<b>F</b>	
Bilge water check.....	64	Fire extinguisher check .....	68
Bilge water, draining.....	57	Fire extinguisher container.....	53
Bilge water, draining on land.....	57	Fire extinguisher container checks.....	68
Bilge water, draining on water.....	58	Flushing the cooling water passages .....	83
Boarding alone .....	77	Fuel .....	54
Boarding and starting off from a dock .....	80	Fuel level check .....	63
Boarding the watercraft.....	76	Fuel level meter.....	42
Boarding with passenger(s) .....	77	Fuel level warning .....	42
Bow eye .....	49	Fuel requirements .....	54
Bow storage compartment .....	50	Fuel system checks.....	63
Builder's plate.....	2	Fuses, replacing.....	98
<b>C</b>		<b>G</b>	
Capsized watercraft .....	80	Getting to know your watercraft .....	71
Check engine warning.....	44	Glossary, watercraft .....	21
Cleaning .....	87	Glove compartment.....	51
Cleaning the watercraft .....	84	<b>H</b>	
Cleat.....	49	Handgrip.....	48
Cooling water pilot outlet check .....	70	Hazard information .....	15
Cooling water pilot outlets .....	30	Hood check .....	69
Craft Identification Number (CIN).....	1	Hour meter/voltmeter .....	41
Cruise assist.....	36	Hull and deck check .....	69
Cruising limitations .....	11	<b>I</b>	
<b>D</b>		Identification numbers .....	1
Digital speedometer .....	40	Information display .....	40
<b>E</b>		<b>J</b>	
Emergency procedures .....	97	Jet intake and impeller, cleaning.....	97
Engine break-in .....	60	Jet intake checks.....	69
Engine compartment check.....	63	Jumper cables, connecting .....	98
Engine cover, removing and installing .....	89	<b>L</b>	
Engine idling speed check .....	70	Labels, important.....	3
Engine oil .....	56	Labels, other .....	8
Engine oil and oil filter.....	92	Labels, warning .....	4
Engine oil level check.....	64	Launching the watercraft.....	72
		Learning to operate your watercraft .....	71
		Leaving the watercraft .....	73

Limitations on who may operate the watercraft.....	10	Safety equipment check.....	69
Long-term storage.....	87	Seat storage compartment.....	52
Low RPM Mode.....	34	Seats.....	47
Lubrication.....	87	Start switch.....	28
<b>M</b>		Starting off.....	79
Main components, location of.....	22	Starting off from a trailer.....	80
Maintenance.....	89	Starting the engine on water.....	72
Model information.....	2	Steering system.....	29
Multifunction display (FX Cruiser SHO) ...	44	Steering system checks.....	65
Multifunction information center.....	39	Stern drain plug checks.....	69
Multifunction information center check....	70	Stern eyes.....	49
<b>N</b>		Stopping the engine.....	73
No-wake mode.....	35	Stopping the watercraft.....	75
<b>O</b>		Storage compartment checks.....	68
Oil pressure warning.....	43	Storage compartments.....	50
Operating in weeded areas.....	82	Submerged watercraft.....	100
Operating the watercraft.....	73	Switch checks.....	68
Operating the watercraft in reverse.....	76	<b>T</b>	
Operating your watercraft.....	71	Throttle lever.....	29
Operation requirements.....	12	Throttle lever checks.....	67
<b>P</b>		Tool kit.....	89
Periodic maintenance chart.....	91	Towing the watercraft.....	100
Post-launch checks.....	69	Transporting on a trailer.....	59
Post-operation care.....	83	Troubleshooting.....	94
Pre-launch checks.....	63	Troubleshooting chart.....	94
Pre-operation check points.....	63	Turning the watercraft.....	74
Pre-operation checklist.....	61	<b>W</b>	
Primary Identification (PRI-ID) number.....	1	Water separator.....	31
Pull-up cleats (FX Cruiser SHO).....	50	Water separator check.....	63
<b>Q</b>		Watercraft characteristics.....	15
Quick Shift Trim System (Q.S.T.S.).....	33	Watercraft control functions.....	26
Quick Shift Trim System (Q.S.T.S.) checks.....	66	Watercraft operation functions.....	32
<b>R</b>		Watercraft operation modes.....	34
Reboarding step.....	48	Water-skiing.....	17
Recommended equipment.....	14	Watertight storage compartment.....	53
Remote control transmitter.....	26	<b>Y</b>	
Remote control transmitter check.....	67	Yamaha Security System.....	27
Reverse system.....	32	Yamaha Security System settings.....	27
Reverse system checks.....	66		
Riding position.....	72		
Rustproofing.....	88		
<b>S</b>			
Safe boating rules.....	19		



Printed in U.S.A.  
July 2009-0.2 × 1 CR