



**2008 WaveRunner
VX
VX Deluxe
VX Cruiser**

OWNER'S/OPERATOR'S MANUAL

YAMAHA MOTOR CO., LTD.
F1K-F8199-73-E0

READ THIS OWNER'S/OPERATOR'S MANUAL CAREFULLY BEFORE OPERATING YOUR WATERCRAFT.

Important manual information

EJU30122

Declaration of Conformity for Personal Watercraft (PWC) with the requirements of Directive 94/25/EC as amended by Directive 2003/44/EC

Revision No:

Name of PWC manufacturer:

YAMAHA MOTOR CO., LTD.

Address: 2500 Shingai

Town: Iwata, Shizuoka **Post Code:** 438-8501

Country: Japan

Name of Authorized Representative (if applicable):

YAMAHA MOTOR EUROPE N.V.

Address: Koolhovenlaan 101

Town: Schiphol-Rijk **Post Code:** 1119 NC

Country: The Netherlands

Name of Notified Body for noise emission assessment: Luxcontrol SA

Address: 1, avenue des Terres Rouges BP 349

Town: Esch-sur-Alzette **Post Code:** L-4004

Country: Luxembourg **ID Number:** 0882

Name of Notified Body for exhaust emission assessment: Luxcontrol SA

Address: 1, avenue des Terres Rouges BP 349

Town: Esch-sur-Alzette **Post Code:** L-4004

Country: Luxembourg **ID Number:** 0882

ECtype-examination Certificate number (if applicable): LC*2003/44*10016

Important manual information

Conformity assessment modules used:

for construction: A Aa B+C B+D B+E B+F G H

for noise emissions: Aa G H

for exhaust emissions: B+C B+D B+E B+F G H

Other Community Directives applied:

Directive 89/336/EEC relating to electromagnetic compatibility (EMC), using the following standards, for emission CISPR12:1997, for generic immunity EN61000-6-2:2001

DESCRIPTION OF CRAFT

Craft model Identification Number, starting from

U S - Y A M A 2 4 8 1 H 7 0 8 -

Model name / Commercial name :

Design Category: C D

VX1100A-G / VX Cruiser, VX1100B-G / VX Deluxe, VX1100-G / VX

IDENTIFICATION OF ENGINE(S) COVERED BY THIS DECLARATION OF CONFORMITY

Combustion cycle: 2 stroke 4 stroke

Unique engine identification number(s) or engine family code(s)	EC Type-examination certificate (for exhaust)
6D3	LC*2003/44*10016

ESSENTIAL REQUIREMENTS	standards	other normative document/ method	technical file	Please specify in more detail (* = mandatory standard)
I.A design and construction	<input checked="" type="checkbox"/>	<input type="checkbox"/>	<input checked="" type="checkbox"/>	EN ISO 13590
I.B exhaust emissions	<input checked="" type="checkbox"/> *	<input type="checkbox"/>	<input checked="" type="checkbox"/>	*EN ISO 8178-1:1996
I.C noise emissions	<input checked="" type="checkbox"/> *	<input type="checkbox"/>	<input checked="" type="checkbox"/>	*EN ISO 14509

This declaration of conformity is issued under the sole responsibility of the PWC manufacturer. I declare on behalf of the PWC manufacturer that the craft model and engine(s) mentioned above comply with all applicable essential requirements in the way specified and are in conformity with the type for which above mentioned EC type-examination certificate(s) has(have) been issued.

Name / title: T. Tsuchiya / President of YAMAHA MOTOR EUROPE N.V.

(identification of the person empowered to sign on behalf of the PWC manufacturer or his authorized representative)

Signature: _____
(or an equivalent marking)

Date and place of issue: 1st / August / 2007, Schiphol-Rijk, The Netherlands

Important manual information

EJU30190

To the owner/operator

Thank you for choosing a Yamaha watercraft. This owner's/operator's manual contains information you will need for proper operation, maintenance, and care. If you have any questions about the operation or maintenance of your watercraft, please consult a Yamaha dealer.

This manual is not a course on boating safety or seamanship. If this is your first watercraft, or if you are changing to a type of watercraft you are not familiar with, for your own comfort and safety, please ensure that you obtain proper training or practice before operating the watercraft by yourself. In addition, a Yamaha dealer or boating organization will be pleased to recommend local sea schools, or competent instructors.

Because Yamaha has a policy of continuing product improvement, this product may not be exactly as described in this owner's/operator's manual. Specifications are subject to change without notice.

This manual should be considered a permanent part of this watercraft and should remain with it even if the watercraft is subsequently sold.

In this manual, information of particular importance is distinguished in the following ways:

 The Safety Alert Symbol means ATTENTION! BECOME ALERT! YOUR SAFETY IS INVOLVED!

EWJ00070

WARNING

Failure to follow WARNING instructions could result in severe injury or death to the machine operator, passengers, a bystander, or a person inspecting or repairing the watercraft.

ECJ00090

CAUTION:

A CAUTION indicates special precautions that must be taken to avoid damage to the watercraft.

NOTE:

A NOTE provides key information to make procedures easier or clearer.

EJU30230

**WaveRunner VX/VX Deluxe/VX Cruiser
OWNER'S/OPERATOR'S MANUAL
©2007 by Yamaha Motor Co., Ltd.
1st Edition, June 2007
All rights reserved.
Any reprinting or unauthorized use
without the written permission of
Yamaha Motor Co., Ltd.
is expressly prohibited.
Printed in USA**

Table of contents

General and important labels	1	Bow eye	28
Identification numbers	1	Stern eyes	28
Primary Identification (PRI-ID)		Yamaha Engine Management	
number	1	System (YEMS)	28
Craft Identification Number (CIN)	1	Yamaha Security System and	
Engine serial number	1	low-RPM mode (for VX Deluxe/ VX Cruiser)	29
Model information	2	Multifunction information center	30
Builder's plate	2	Storage compartments	35
Important labels	3		
Warning labels	4		
Other labels	7		
Safety information	9	Operation	38
Limitations on who may operate		Fuel and oil	38
the watercraft	9	Gasoline	38
Cruising limitations	10	Engine oil	39
Operation requirements	11	Filling the fuel tank	39
Recommended equipment	13	Pre-operation checks	40
Hazard information	14	Pre-operation check list	40
Watercraft characteristics	14	Pre-operation check points	42
Water-skiing	16	Operation	49
Safe boating rules	17	Engine break-in	49
Enjoy your watercraft		Launching the watercraft	49
responsibly	18	Starting the engine	49
		Stopping the engine	51
		Leaving the watercraft	51
		Operating your watercraft	52
		Getting to know your watercraft	52
		Learning to operate your	
		watercraft	52
		Riding with passengers	53
		Starting the watercraft	53
		Boarding and starting in deep	
		water	54
		Capsized watercraft	57
		Turning the watercraft	58
		Stopping the watercraft	60
		Beaching the watercraft	60
		Docking the watercraft	60
		Reverse on waterways	
		(for VX Deluxe/VX Cruiser)	60
		Rough water operation	61
Features and functions	19		
Location of main components	19		
Operation of controls and other			
functions	23		
Seat	23		
Hood	23		
Fuel tank filler cap	24		
Remote control transmitter			
(for VX Deluxe/VX Cruiser)	24		
Engine stop switch	25		
Engine shut-off switch	25		
Start switch	26		
Throttle lever	26		
Cooling water pilot outlet	26		
Steering system	27		
Shift lever (for VX Deluxe/ VX Cruiser)	27		
Handgrip	28		

Table of contents

Post-operation care	61
Transporting	62
Maintenance and care.....	63
Storage	63
Flushing the cooling system	63
Lubrication	64
Fuel system	64
Battery	65
Cleaning the watercraft	65
Maintenance and adjustments	66
Owner's/operator's manual and tool kit	67
Periodic maintenance chart	68
Checking the fuel system	70
Engine oil and oil filter	70
Air filter element	71
Checking the jet thrust nozzle angle	71
Checking the shift cable (for VX Deluxe/VX Cruiser)	71
Checking and adjusting the throttle cable	72
Cleaning and adjusting the spark plugs	72
Lubrication points	73
Checking the battery	74
Fuel injection system	75
Specifications	77
Specifications	77
Trouble recovery	78
Troubleshooting	78
Troubleshooting chart	78
Emergency procedures	80
Cleaning the jet intake and impeller	80
Jumping the battery	81
Replacing the fuses	82
Towing the watercraft	83
Submerged watercraft	83

General and important labels

EJU36450

Identification numbers

Record the Primary Identification (PRI-ID) number, Craft Identification Number (CIN), and engine serial number in the spaces provided for assistance when ordering spare parts from a Yamaha dealer. Also record and keep these ID numbers in a separate place in case your watercraft is stolen.

EJU30281

Primary Identification (PRI-ID) number

The PRI-ID number is stamped on a plate attached inside the engine compartment.

MODEL:

VX1100-G (VX)

VX1100B-G (VX Deluxe)

VX1100A-G (VX Cruiser)

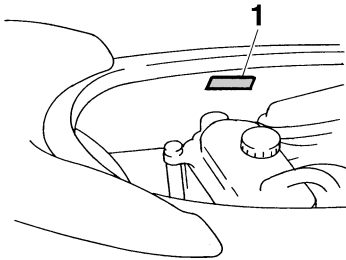

1 Primary Identification (PRI-ID) number location

MODEL	<input type="text"/>	PRI-ID.	<input type="text"/>
YAMAHA MOTOR CO., LTD. ASSEMBLED IN U.S.A. FROM AMERICAN AND JAPANESE COMPONENTS.		F1K <input type="text"/>	
ASSEMBLÉ AUX ÉTATS-UNIS DE PIÈCES AMÉRICAINES ET JAPONAISES.			

F1K -

EJU36550

Craft Identification Number (CIN)

The CIN is stamped on a plate attached to the aft deck.

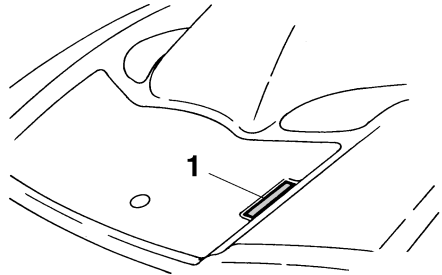

1 Craft Identification Number (CIN) location

US - YAM

EJU30310

Engine serial number

The engine serial number is stamped on a plate attached to the engine unit.

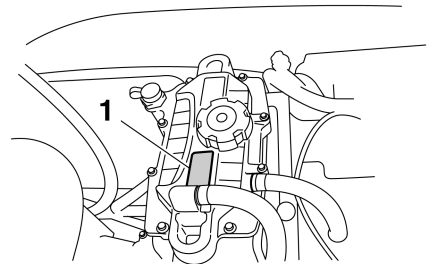

1 Engine serial number location

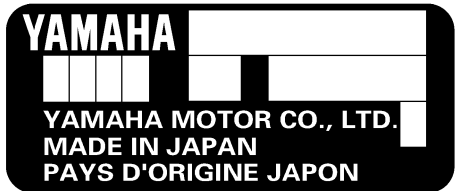

General and important labels

EJU30320

Model information

EJU30330

Builder's plate

Part of the information is given on the builder's plate affixed on the craft. A full explanation of this information is given in the relevant sections of this manual.

which approximately corresponds to the wave height estimated by an experienced observer. However, some waves will be double this height.

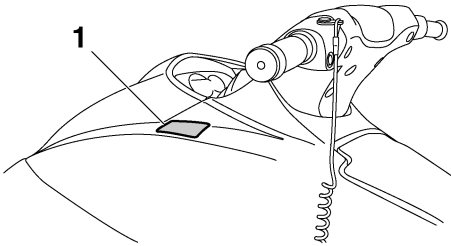

1 Builder's plate location

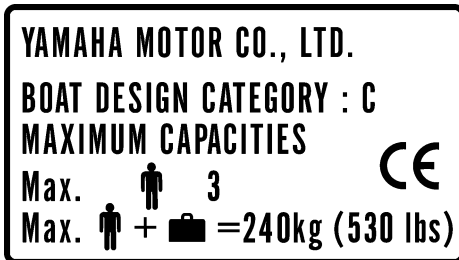

Design category of this personal watercraft: C

Category C:

This watercraft is designed to operate in winds up to Beaufort force 6 and the associated wave heights (significant wave heights up to 2 m (6.56 ft); see the following NOTE). Such conditions may be encountered in exposed inland waters, in estuaries, and in coastal waters in moderate weather conditions.

NOTE: _____

The significant wave height is the mean height of the highest one-third of the waves,

General and important labels

EJU30450

Important labels

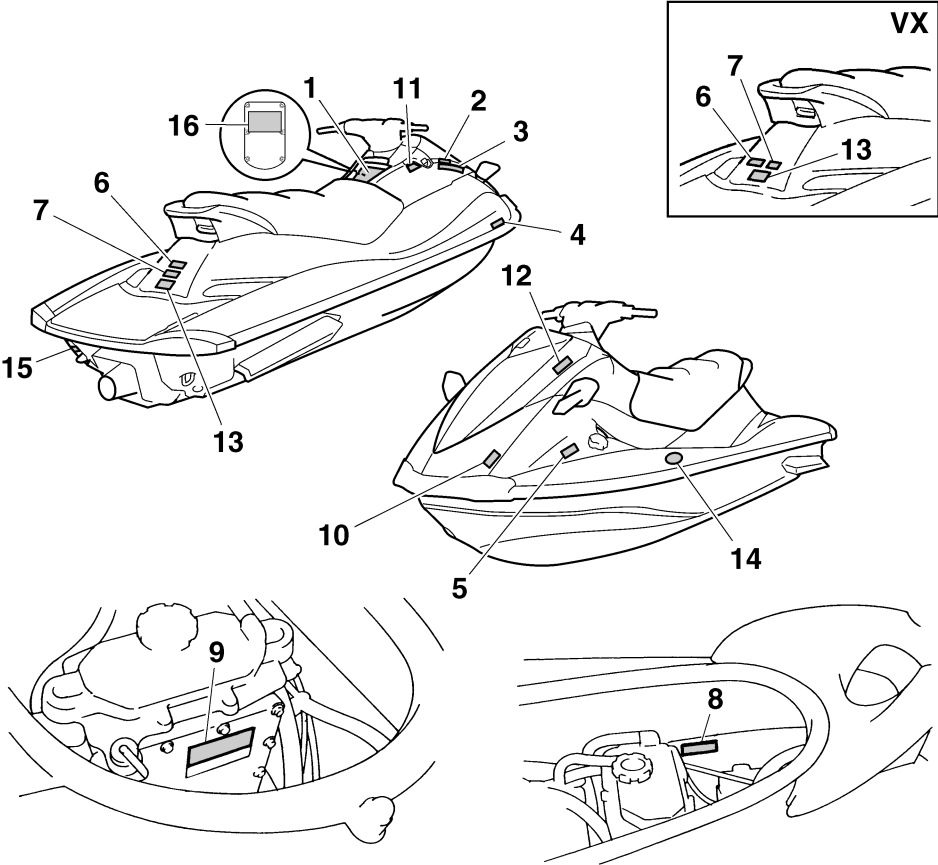

General and important labels

EJU35910

Warning labels

1

WARNING

To reduce the risk of SEVERE INJURY or DEATH:

WEAR A PERSONAL FLOTATION DEVICE (PFD).

All riders must wear an authority-approved PFD that is suitable for personal watercraft (PWC) use.

WEAR PROTECTIVE CLOTHING. Severe internal injuries can occur if water is forced into body cavities as a result of falling into water or being near jet thrust nozzle. Normal swimwear does not adequately protect against forceful water entry into rectum or vagina. All riders must wear a wet suit bottom or clothing that provides equivalent protection (See Owner's Manual).

Footwear, gloves, and goggles/glasses are recommended.

KNOW BOATING LAWS. Yamaha Motor Co., Ltd. recommends a minimum operator age of 16 years old. Know the operator age and training requirements for your state. A boating safety course is recommended and may be required in your state.

ATTACH ENGINE SHUT-OFF CORD (LANYARD) to wrist and keep it free from handlebars so that engine stops if operator falls off. After riding, remove cord from PWC to avoid unauthorized use by children or others.



RIDE WITHIN YOUR LIMITS AND AVOID AGGRESSIVE MANEUVERS to reduce the risk of loss of control, ejection, and collision. This is a high performance boat - not a toy. Sharp turns or jumping wakes or waves can increase the risk of back/spinal injury (paralysis), facial injuries, and broken legs, ankles, and other bones. Do **not** jump wakes or waves.

DO NOT APPLY THROTTLE WHEN ANYONE IS AT REAR OF PWC - turn engine off or keep engine at idle. Water and/or debris exiting jet thrust nozzle can cause severe injury.

KEEP AWAY FROM INTAKE GRATE while engine is on. Items such as long hair, loose clothing, or PFD straps can become entangled in moving parts resulting in severe injury or drowning.

NEVER RIDE AFTER CONSUMING DRUGS OR ALCOHOL

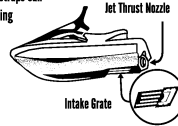

READ AND FOLLOW OWNER'S MANUAL

WARNING

Collisions result in more INJURIES AND DEATHS than any other type of accident for personal watercraft (PWC).

TO AVOID COLLISIONS:

SCAN CONSTANTLY for people, objects, and other watercraft. Be alert for conditions that limit your visibility or block your vision of others.

OPERATE DEFENSIVELY at safe speeds and keep a safe distance away from people, objects, and other watercraft.

- Do not follow directly behind PWCs or other boats.
- Do not go near others to spray or splash them with water.
- Avoid sharp turns or other maneuvers that make it hard for others to avoid you or understand where you are going.
- Avoid areas with submerged objects or shallow water.

TAKE EARLY ACTION to avoid collisions. Remember, PWCs and other boats **do not have brakes**.

DO NOT RELEASE THROTTLE WHEN TRYING TO STEER away from objects - **you need throttle to steer**.

Always check throttle and steering controls for proper operation before starting PWC.

Follow navigation rules and state/province and local laws that apply to PWCs. See Owner's Manual for more information.

YAMAHA



FIKU41B1-11

General and important labels

2

▲ AVERTISSEMENT

Les collisions sont la cause principale des BLESSURES ET DÉCÈS d'utilisateurs de scooter des mers. **POUR ÉVITER LES COLLISIONS: ÊTRE CONSTAMMENT à l'affût de personnes, d'objets et d'autres bateaux. Être conscient des conditions limitant sa visibilité ou celle des autres embarcations.**

PILOTER AVEC PRUDENCE à des vitesses raisonnables et garder une distance de sécurité entre le scooter et toute personne, objet et embarcation.

- Ne pas suivre une autre embarcation de trop près.
- Ne pas se rapprocher d'autrui en vue de l'éclabousser.
- Éviter les virages brusques ou toute manœuvre qui risque de mettre un autre pilote en danger ou qui empêche de pouvoir déterminer clairement la direction que l'on prend.
- Éviter les endroits où flottent des objets et les eaux peu profondes.

REAGIR RAPIDEMENT en vue d'éviter les collisions. Garder à l'esprit que les bateaux n'ont pas de freins.

NÉ PAS LÂCHER LES GAZ LORSQUE L'ON ESSAIE DE S'ÉLOIGNER d'objets ou une boussie est nécessaire à la direction du scooter des mers. Toujours s'assurer avant le départ que l'accélérateur et la direction fonctionnent correctement. Suivre les lois de navigation ainsi que les législations nationales, provinciales et locales concernant les scooters des mers. Voir le manuel d'utilisation pour plus d'informations.

F1B-U41B2-01

3

▲ AVERTISSEMENT

Afin de limiter les risques de BLESSURES GRAVES, voire MORTELLES: **PORTER UN GILET DE SAUVETAGE.** Tout utilisateur doit porter un gilet de sauvetage homologué pour les scooters des mers. **PORTER DES VÊTEMENTS PROTÉCTEURS.** Le choc infligé par la pénétration forcée d'eau dans les orifices corporels lors d'une chute ou lors du contact avec le jet d'eau de la pompe risque de provoquer des lésions graves. Le port d'un simple maillot de bain ne constitue pas une protection adéquate contre la pénétration de l'eau dans le rectum et/ou le vagin. Tout utilisateur doit porter le bandon d'une tenue de plongée ou tout autre vêtement offrant une protection semblable. (Voir le manuel d'utilisation.) Le port de chaussures, de gants et de lunettes de plongée est recommandé. **CONNÂTRE LES LOIS DE NAVIGATION:** La Yamaha Motor Co., Ltd. recommande la limite d'âge de pilotage de 16 ans. Vérifier l'âge du pilote ainsi que les exigences quant à l'âge prévues par la législation locale. Il est préférable, et parfois requis par certaines législations, de suivre un cours de sécurité maritime. **ATTACHER LA LANIÈRE DE L'INTERRUPTEUR D'ARRÊT DU MOTEUR** au poignet et l'éloigner du guidon afin que le moteur se coupe bien en cas de chute. Après utilisation, retirer la lanière du scooter afin de prévenir toute utilisation par des enfants ou des personnes non autorisées.

F1B-U41B1-21

4

▲ AVERTISSEMENT

Afin de limiter les risques de BLESSURES GRAVES, voire MORTELLES:

RESPECTER SES LIMITES ET ÉVITER LES MANŒUVRES BRUTALES afin de limiter tout risque de perte de contrôle, d'éjection et de collision. Il s'agit d'un véhicule à hautes performances et pas d'un jouet. Des virées brusques ou le saut de sillages ou de vagues accroît le risque de blessures au dos, voire de paralysie, de blessures au visage et de fractures diverses. **Ne jamais sauter des sillages ni des vagues.**

NE PAS DONNER DES GAZ LORSQUE QUELQU'UN SE TROUVE DERRIÈRE LE VÉHICULE: couper le moteur ou laisser tourner au ralenti. Eau et/ou débris projetés par la pompe pourraient causer des blessures graves.

NE PAS S'APPROCHER DE LA GRILLE D'ADMISSION lorsque le moteur tourne. Cheveux longs, vêtements amples ou lanières de gilet de sauvetage risquent d'être happés, ce qui pourrait provoquer des blessures, ou même une noyade.

NE JAMAIS PILOTER APRÈS AVOIR ABSORBÉ DE L'ALCOOL, DES DROGUES OU CERTAINS MÉDICAMENTS.

LIRE ET RESPECTER LES INSTRUCTIONS DONNÉES DANS LE MANUEL D'UTILISATION.

F1B-U41B1-31

▲ AVERTISSEMENT

Afin de limiter les risques de BLESSURES GRAVES, voire MORTELLES:

RESPECTER SES LIMITES ET ÉVITER LES MANŒUVRES BRUTALES afin de limiter tout risque de perte de contrôle, d'éjection et de collision. Il s'agit d'un véhicule à hautes performances et pas d'un jouet. Des virées brusques ou le saut de sillages ou de vagues accroît le risque de blessures au dos, voire de paralysie, de blessures au visage et de fractures diverses. **Ne jamais sauter des sillages ni des vagues.**

NE PAS DONNER DES GAZ LORSQUE QUELQU'UN SE TROUVE DERRIÈRE LE VÉHICULE: couper le moteur ou laisser tourner au ralenti. Eau et/ou débris projetés par la pompe pourraient causer des blessures graves.

NE PAS S'APPROCHER DE LA GRILLE D'ADMISSION lorsque le moteur tourne. Cheveux longs, vêtements amples ou lanières de gilet de sauvetage risquent d'être happés, ce qui pourrait provoquer des blessures, ou même une noyade.

NE JAMAIS PILOTER APRÈS AVOIR ABSORBÉ DE L'ALCOOL, DES DROGUES OU CERTAINS MÉDICAMENTS.

LIRE ET RESPECTER LES INSTRUCTIONS DONNÉES DANS LE MANUEL D'UTILISATION.

F0V-U41B1-31

5

General and important labels

5

<p style="text-align: center;">▲ WARNING</p> <p>Gasoline is highly flammable and explosive. A fire or explosion could cause severe injury or death. Shut engine off. Refuel in well ventilated area away from flames or sparks. Do not smoke. Avoid spilling gasoline. Wipe up spilled gasoline immediately. Remove all seats to ventilate fuel vapors from engine compartment before starting engine. Do not start engine if there is a fuel leak or a loose electrical connection.</p>	<p style="text-align: center;">▲ AVERTISSEMENT</p> <p><i>L'essence est très inflammable et explosive. Un incendie ou une explosion risquent de provoquer des blessures graves, voire mortelles. Couper le moteur. Faire le plein dans un endroit bien aéré et éloigné de toute flamme ou étincelle. Ne pas fumer. Éviter de renverser de l'essence. Essayer immédiatement toute coulure d'essence. Déposer les selles pour évacuer les vapeurs d'essence du compartiment du moteur avant de mettre le moteur en marche. Ne jamais mettre le moteur en marche en cas de fuite d'essence ou si un branchement électrique est desserré.</i></p>
REGULAR UNLEADED GASOLINE ONLY	ESSENCE NORMALE SANS PLOMB UNIQUEMENT

F1B-U415B-11
F1S-U415B-11

6

<p style="text-align: center;">▲ WARNING</p> <p>Do not use cleat or grips to lift PWC. PWC could fall, which could result in severe injury.</p>
<p style="text-align: center;">▲ AVERTISSEMENT</p> <p>Ne pas soulever le scooter à l'aide du taquet ou des poignées. Le scooter pourrait tomber et provoquer des blessures graves.</p>



(F0V-U41E1-41)
(F1S-U41E1-11)

7

<p style="text-align: center;">▲ WARNING</p> <ul style="list-style-type: none"> • Severe internal injuries can occur if water is forced into body cavities as a result of being near jet thrust nozzle. • Wear a wetsuit bottom or clothing that provides equivalent protection. • Do not board PWC if operator is applying throttle.
<p style="text-align: center;">▲ AVERTISSEMENT</p> <ul style="list-style-type: none"> • Le choc infligé par la pénétration forcée d'eau dans les orifices corporels lors du contact avec le jet de la pompe risque de provoquer des lésions graves. • Porter le pantalon d'une tenue de plongée ou tout autre vêtement offrant une protection semblable. • Ne pas embarquer lorsque la pilote donne des gaz.

(F0V-U41E1-41)
(F1S-U41E1-11)

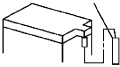
8

<p style="text-align: center;">▲ WARNING</p> <p>Be sure to connect breather hose to battery. Fire or explosion could result if not connected properly.</p>	<p>Breather hose</p> 
<p style="text-align: center;">▲ AVERTISSEMENT</p> <p>Bien veiller à brancher la durit de mise à l'air à la batterie. Un mauvais branchement risque d'être à l'origine d'un incendie ou d'une explosion.</p>	<p>Mise à l'air</p> 

YAMAHA

F0V-U41DB-12

9

<p style="text-align: center;">▲ WARNING / AVERTISSEMENT / 警告</p> <p>Do not touch or remove electrical parts when starting or running the engine.</p>
<p>Ne pas toucher ou retirer les pièces électriques lors du démarrage ou de la marche du moteur.</p>
<p>運転中は電装品には触らないでください。</p>

YAMAHA

8B6-83623-00

General and important labels

10

⚠ AVERTISSEMENT
APPLICABLE POUR LA FRANCE SEULEMENT

- *En France : permis de conduire et immatriculation obligatoire.*
- *Navigation en mer autorisée entre 300 mètres et 2 milles nautiques.*
- *Entre 0 et 300 mètres, se référer aux instructions nautiques locales affichées. Sinon, règle générale : vitesse maxi 5 noeuds (9Km/h) dans cette zone.*
- *Utiliser les chenaux obligatoires de sortie lorsqu'ils existent.*
- *Respecter les règles de priorité.*
- *Gilet de sauvetage obligatoire-Fusée et bout de remorquage à bord.*
- *Ne jamais conduire sous l'influence de l'alcool ou de drogues.*
- *Consulter la météo avant de sortir en mer.*
- *Une conduite responsable et un contrôle quotidien de votre machine suivant le manuel d'entretien YAMAHA seront garants de votre sécurité.*

YAMAHA

GJ3-U418H-01
GP8-U418H-01

For VX Deluxe/VX Cruiser only

11

⚠ WARNING
REVERSE SHIFT LEVER OPERATION:

- Shift only while engine is idling or off.
- Reverse is for low speed maneuvering only.
- Do not use reverse function to slow down or stop PWC as it could cause you to lose control, be ejected, or impact handlebars.
- Make sure that there are no obstacles or people behind you before shifting to reverse.

⚠ AVERTISSEMENT
FONCTIONNEMENT DU LEVIER D'INVERSION DE MARCHE:

- *Inverser la marche uniquement lorsque le moteur tourne au ralenti ou lorsqu'il est coupé.*
- *La marche arrière est destinée exclusivement aux manœuvres à vitesse réduite.*
- *Ne pas sélectionner la marche arrière en vue de ralentir ou d'arrêter le scooter des mers, car il y a risque de perte de contrôle, d'éjection ou de heurt sur le guidon.*
- *S'assurer qu'il n'y a ni obstacle ni personne derrière le scooter avant d'engager la marche arrière.*

FOV-U41D5-31

EJU36123

Other labels

12

FIRE EXTINGUISHER CONTAINER
COMPARTIMENT DE L'EXTINCTEUR

F1B-U41F5-21

13

RATED PERSON CAPACITY: 3
MAXIMUM LOAD: 240 kg (530 lb)
CAPACITÉ MAXIMALE: 3 personnes
CHARGE MAXIMALE: 240 kg(530 lb)

(FOV-U41E1-41)
(F1S-U41E1-11)

General and important labels

14



The following label indicates the correct direction to upright a capsized watercraft.

15

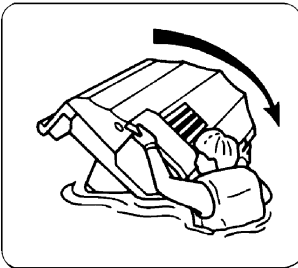

GA9-U418F-00
F1G-U418F-00

For VX Deluxe/VX Cruiser only

The following CE marking is located on the back of the remote control transmitter.

16

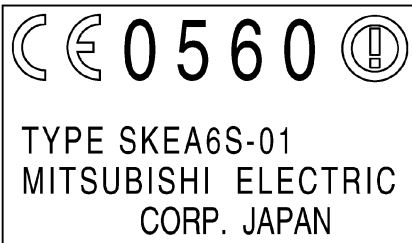

Safety information

EJU30680

The safe use and operation of this watercraft is dependent upon the use of proper riding techniques, as well as upon the common sense, good judgment, and expertise of the operator. Before using this watercraft, make sure that its use is permitted under local laws, bylaws, and regulations, and always operate the watercraft in full conformity with any requirements and limitations imposed. Every operator should know the following requirements before riding the watercraft.

- Before operating the watercraft, read this owner's/operator's manual, the Riding Practice Guide, and all warning and caution labels on the watercraft. These materials should give you an understanding of the watercraft and its operation.
- Never allow anyone to operate this watercraft until they too have read this owner's/operator's manual, the Riding Practice Guide, and all warning and caution labels.

EJU30740

Limitations on who may operate the watercraft

- Yamaha recommends a minimum operator age of 16 years old. Adults must supervise use by minors. Know your local operator age and training requirements.
- This watercraft is designed to carry the operator and up to 2 passengers. Never exceed the maximum load limit or allow more than 3 persons (or 2 persons if a water-skier is being pulled) to ride the watercraft at any time.



Maximum load:
240 kg (530 lb)
Load is the total weight of cargo, operator, and passengers.

- Do not operate the watercraft with any passengers on board until you have considerable practice and experience riding alone. Operating the watercraft with passengers requires more skill. Take the time to become accustomed to the handling characteristics of the watercraft before trying any difficult maneuvers.

EJU30760

Cruising limitations

- Scan constantly for people, objects, and other watercraft. Be alert for conditions that limit your visibility or block your vision of others.

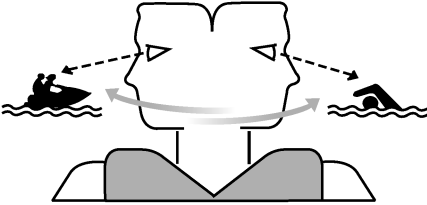

- Operate defensively at safe speeds and keep a safe distance away from people, objects, and other watercraft.
- Do not follow directly behind watercraft or other boats.
- Do not go near others to spray or splash them with water.
- Avoid sharp turns or other maneuvers that make it hard for others to avoid you or understand where you are going.
- Avoid areas with submerged objects or shallow water.
- Take early action to avoid collisions. Remember, watercraft and other boats do not have brakes.
- Do not release the throttle lever when trying to steer away from objects—you need throttle to steer. Always check throttle and steering controls before starting the watercraft.
- Ride within your limits and avoid aggressive maneuvers to reduce the risk of loss of control, ejection, and collision.
- This is a high performance boat—not a toy. Sharp turns or jumping wakes or waves can increase the risk of back/spinal injury (paralysis), facial injuries, and broken legs, an-

cles, and other bones. Do not jump wakes or waves.

- Do not operate the watercraft in rough water, bad weather, or when visibility is poor; this may lead to an accident causing injury or death. Be alert to the possibility of adverse weather. Take note of weather forecasts and the prevailing weather conditions before setting out on your watercraft.
- As with any water sport, you should not operate your watercraft without someone else nearby. If you operate further than swimming distance from shore, you should be accompanied by another boat or watercraft, but make sure you stay a safe distance away. It's good, common sense!
- Never operate in water that is less than 60 cm (2 ft) deep, otherwise you increase your chance of hitting a submerged object, which could result in injury.

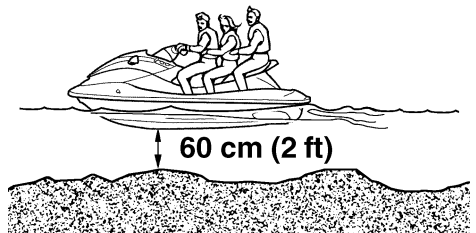

- This watercraft is not equipped with lighting required for night operation. Do not operate the watercraft after sunset or before dawn, otherwise you increase the risk of colliding

Safety information

with another boat, which could result in severe injury or death.



- Follow navigation rules, and state/provincial and local laws that apply to watercraft.

EJU30820

Operation requirements

- All riders must wear a personal flotation device (PFD) that is approved by the appropriate authorities and is suitable for personal watercraft use.
- Wear protective clothing. Severe internal injuries can occur if water is forced into body cavities as a result of falling into the water or being near the jet thrust nozzle. Normal swimwear does not adequately protect against forceful water entry into the rectum or vagina. All riders must wear a wetsuit bottom or clothing that provides equivalent protection. Such clothing includes thick, tightly woven, sturdy and snug-fitting apparel such as denim, but does not include spandex or similar fabrics, like those used in bicycle shorts.

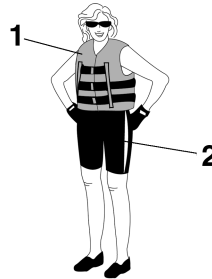

- 1 Authority-approved PFD
- 2 Wetsuit bottom

- Eye protection is recommended to keep wind, water, and glare from the sun out of your eyes while you operate your watercraft. Restraining straps for eyewear are made which are designed to float should your eyewear fall in the water. Footwear and gloves are recommended.
- You must decide whether to wear a helmet while you ride for recreation. You should know that a helmet could help protect you in

Safety information

certain kinds of accidents and that it could injure you in others.

A helmet is designed to provide some head protection. Although helmets cannot protect against all foreseeable impacts, a helmet might reduce your injuries in a collision with a boat or other obstacle.

A helmet may have potential safety hazards, as well. Falling into the water could risk the chance of the helmet catching water, commonly known as “bucketing”, and the resulting strain on your neck could cause choking, severe and permanent neck injuries, or death. A helmet could also increase the risk of an accident if it reduces your vision or hearing, or if it distracts you or increases your fatigue.

How should you decide if a helmet’s potential safety benefits outweigh its potential risks for you? Consider your particular riding conditions. Consider factors such as your riding environment and your riding style and ability. Also consider the likelihood of traffic congestion, and the water surface conditions.

If you decide to wear a helmet based upon your riding circumstances, choose one carefully. Look for a helmet designed for personal watercraft use, if possible. If you will be engaging in closed-course competition, follow the helmet requirements of the sanctioning organization.

- NEVER operate the watercraft after consuming alcohol or taking other drugs.



- For reasons of safety and proper care of the watercraft, always perform the pre-operation checks listed on page 40 before operating the watercraft.
- The operator and passengers should always keep their feet on the floor of the footwell when the watercraft is in motion. Lifting your feet increases the chances of losing your balance, or hitting objects outside the watercraft with your feet. Do not give a ride to children if their feet cannot reach the floor of the footwell.
- The passengers should hold on firmly, either to the person in front of them or to the handgrip provided.



- Never allow a passenger to ride in front of the operator.

Safety information

- Always consult your doctor on whether it is safe for you to ride this watercraft if you are pregnant or in poor health.
- Do not attempt to modify this watercraft! Modifications to your watercraft may reduce safety and reliability, and render the watercraft unsafe or illegal for use.
- Attach the engine shut-off cord to your left wrist and keep it free from the handlebars so that the engine stops if you, the operator, fall off. After riding, remove the engine shut-off cord from the watercraft to avoid accidental starting or unauthorized use by children or others.

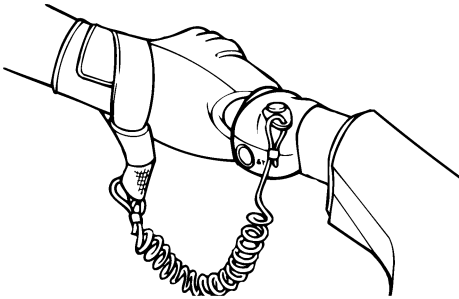

- Scan carefully for swimmers and stay away from swimming areas. Swimmers are hard to see and you could accidentally hit someone in the water.
- Avoid being hit by another boat! You should always take the responsibility to watch for traffic; other boaters may not be watching for you. If they do not see you, or if you maneuver more quickly than other boaters expect, you risk a collision.
- Maintain a safe distance from other boats and watercraft, and also watch for ski ropes or fishing lines. Obey the “Safe boating rules” and be sure to check behind you before making a turn. (See “Safe boating rules” on page 17.)

EJU30840

Recommended equipment

The following items should be carried on board your watercraft:

- Sound-signaling device
You should carry a whistle or other sound-signaling device that can be used to signal other boats.
- Visual distress signals
It is recommended that a pyrotechnic device, which is approved by the appropriate authorities, be stored in a waterproof container on your watercraft. A mirror can also be used as an emergency signal. Contact a Yamaha dealer for more information.
- Watch
A watch is helpful so you will know how long you have been operating the watercraft.
- Towline
A towline can be used to tow a disabled watercraft in an emergency.

EJU30870

Hazard information

- Never start the engine or let it run for any length of time in an enclosed area. Exhaust fumes contain carbon monoxide, a colorless, odorless gas that may cause loss of consciousness and death within a short time. Always operate the watercraft in an open area.
- Do not touch the hot oil tank, muffler, or engine during or immediately after engine operation; they can cause serious burns.

EJU30930

Watercraft characteristics

- Jet thrust turns the watercraft. Releasing the throttle lever completely produces only minimum thrust. If you are traveling at speeds above trolling, you will have rapidly decreasing ability to steer without throttle. This model is equipped with the Yamaha Engine Management System (YEMS) that includes an off-throttle steering (OTS) system. It will activate at planing speeds should you attempt to steer the watercraft after releasing the throttle lever. The OTS system assists in turning by continuing to supply some thrust while the watercraft is decelerating, but you can turn more sharply if you apply throttle while turning the handlebars. The OTS system does not function below planing speeds or when the engine is off. Once the engine slows down, the watercraft will no longer turn in response to handlebar input until you apply throttle again or you reach trolling speed. Practice turning in an open area without obstacles until you have a good feel for this maneuver.
- This watercraft is water-jet propelled. The jet pump is directly connected to the engine. This means that jet thrust will produce some movement whenever the engine is running. There is no “neutral” position. You are in either “forward” or “reverse”, depending upon the shift lever position (for VX Deluxe/VX Cruiser).
- For VX Deluxe/VX Cruiser:
Do not use the reverse function to slow down or stop the watercraft as it could cause you to lose control, be ejected, or impact the handlebars.
This could increase the risk of back/spinal injury (paralysis), facial injuries, and broken

Safety information

legs, ankles, and other bones. You could also damage the shift mechanism.

- For VX Deluxe/VX Cruiser:

Reverse can be used to slow down or stop during slow-speed maneuvering, such as when docking. Once the engine is idling, shift into reverse and gradually increase engine speed. Make sure that there are no obstacles or people behind you before shifting into reverse.

- Keep away from the intake grate while the engine is on. Items such as long hair, loose clothing, or PFD straps can become entangled in moving parts, resulting in severe injury or drowning.
- Never insert any object into the jet thrust nozzle while the engine is running. Severe injury or death could result from coming in contact with the rotating parts of the jet pump.

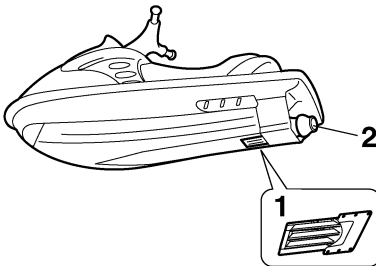

- 1 Intake grate
- 2 Jet thrust nozzle

- Stop the engine and remove the clip from the engine shut-off switch before removing

any debris or weeds, which may have collected around the jet intake.

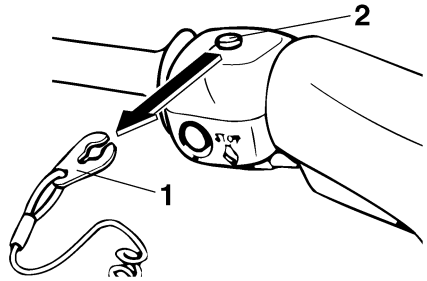

- 1 Clip
- 2 Engine shut-off switch

EJU30950

Water-skiing

You can use the watercraft for water-skiing if it has the seating capacity to carry the operator, a rearward-facing spotter, and the water-skier when he or she is not skiing.

The watercraft must also have a cleat designed to pull a ski rope; do not attach the rope to any other location.

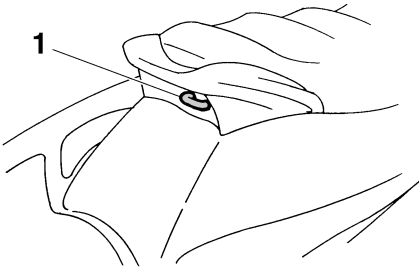

1 Cleat

It is the watercraft operator's responsibility to be alert to the safety of the water-skier and others. Know and follow all local water-skiing regulations in effect for the waters in which you will be operating.

The operator should be comfortable carrying passengers before attempting to pull a skier. The following are some important considerations for minimizing risks while water-skiing.

- The skier should wear an approved PFD, preferably a brightly colored one so boat operators can see the skier.
- The skier should wear protective clothing. Severe internal injuries can occur if water is forced into body cavities as a result of falling into the water. Normal swimwear does not adequately protect against forceful water entry into the rectum or vagina. The skier should wear a wetsuit bottom or clothing that provides equivalent protection.
- A second person should be on board as a spotter to watch the skier; in many places it

is required by law. Let the skier direct the operator's control of speed and direction with hand signals.

The spotter should sit astride the rear of the seat and hold onto the handgrip with both feet firmly on the floor of the footwell for proper balance while facing to the rear to watch the skier's hand signals and condition.

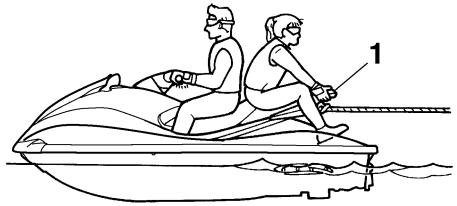

1 Handgrip

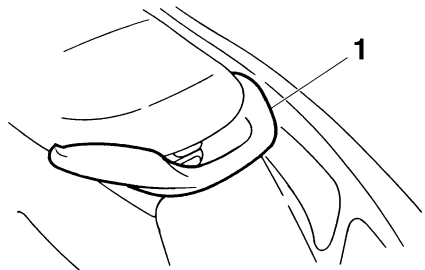

1 Handgrip

- Your control while pulling a water-skier is affected by the skier's ability, as well as water and weather conditions.
- When preparing to pull a skier, operate the watercraft at the slowest possible speed until the watercraft is well away from the skier and slack in the ski rope is taken up.

Safety information

Make sure that the rope is not looped around anything.

After checking that the skier is ready and that there is no traffic or other obstacles, apply enough throttle to raise the skier.

- Make smooth, wide turns. The watercraft is capable of very sharp turns, which could exceed the abilities of the skier. Keep the skier at least 50 m (150 ft), about twice the distance of a standard ski rope, from any potential hazard.
- Be alert to the hazard of the ski rope handle snapping back at the watercraft when the skier falls or is unable to get up on the skis.
- Towing heavy or bulky objects other than skiers, such as another boat or watercraft, can cause loss of steering control and create a hazardous condition. If you must tow another boat in an emergency situation, operate slowly and cautiously.

EJU30970

Safe boating rules

Your Yamaha watercraft is legally considered a powerboat. Operation of the watercraft must be in accordance with the rules and regulations governing the waterway on which it is used.

EJU30990

Enjoy your watercraft responsibly

You share the areas you enjoy when riding your watercraft with others and with nature. So your enjoyment includes a responsibility to treat these other people, and the lands, waters, and wildlife with respect and courtesy.

Whenever and wherever you ride, think of yourself as the guest of those around you. Remember, for example, that the sound of your watercraft may be music to you, but it could be just noise to others. And the exciting splash of your wake can make waves others won't enjoy.

Avoid riding close to shoreline homes and waterfowl nesting areas or other wildlife areas, and keep a respectful distance from fishermen, other boats, swimmers, and populated beaches. When travel in areas like these is unavoidable, ride slowly and obey all laws.

Proper maintenance is necessary to ensure that the exhaust emission and sound levels of your watercraft will continue to be within regulated limits. You have the responsibility to make sure that the recommended maintenance in this owner's/operator's manual is carried out.

Remember, pollution can be harmful to the environment. Do not refuel or add oil where a spill could cause damage to nature. Remove your watercraft from the water and move it away from the shoreline before refueling. And keep your surroundings pleasant for the people and wildlife that share the waterways: don't litter!

When you ride responsibly, with respect and courtesy for others, you help ensure that our waterways stay open for the enjoyment of a variety of recreational opportunities.

Features and functions

EJU31010

Location of main components

Front view

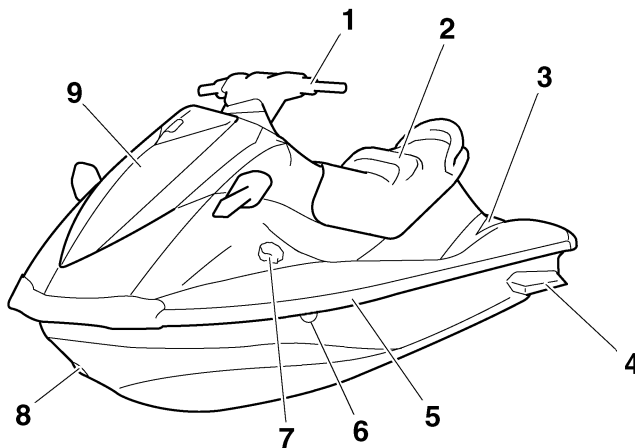

- 1 Handlebars
- 2 Seat
- 3 Footwell
- 4 Sponsons
- 5 Gunwale
- 6 Cooling water pilot outlet
- 7 Fuel tank filler cap
- 8 Bow eye
- 9 Hood

Features and functions

Rear view

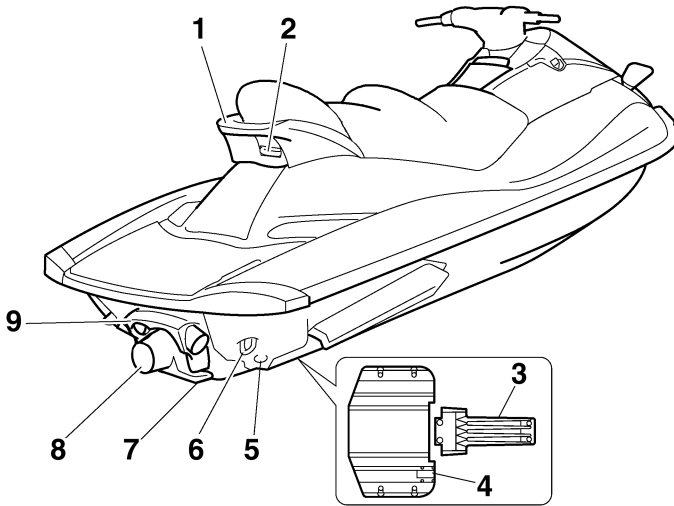

- 1 Handgrip
- 2 Cleat
- 3 Intake grate
- 4 Speed sensor
- 5 Stern drain plugs
- 6 Stern eyes
- 7 Ride plate
- 8 Jet thrust nozzle
- 9 Reverse gate (for VX Deluxe/VX Cruiser)

Features and functions

Control system

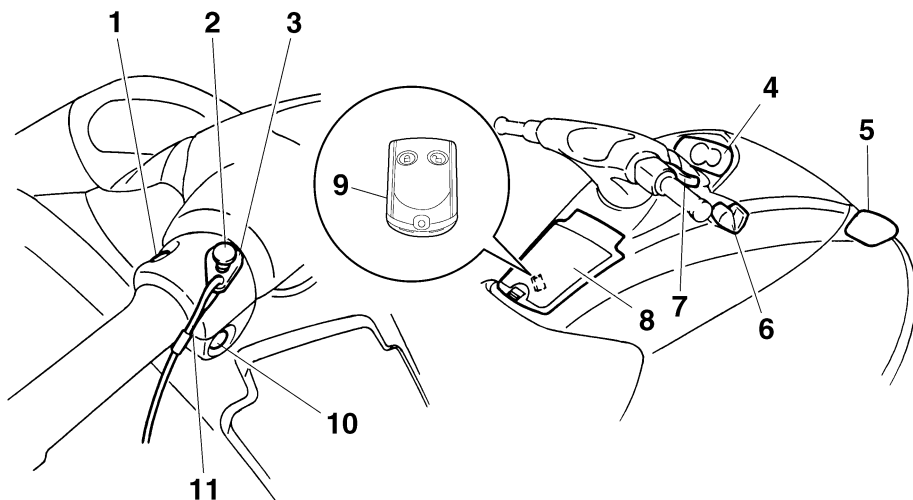

- 1 Start switch
- 2 Engine shut-off switch
- 3 Clip
- 4 Multifunction information center
- 5 Rearview mirrors
(for VX Deluxe/VX Cruiser)
- 6 Shift lever (for VX Deluxe/VX Cruiser)
- 7 Throttle lever
- 8 Glove compartment
- 9 Remote control transmitter
(for VX Deluxe/VX Cruiser)
- 10 Engine stop switch
- 11 Engine shut-off cord (lanyard)

Features and functions

Engine compartment

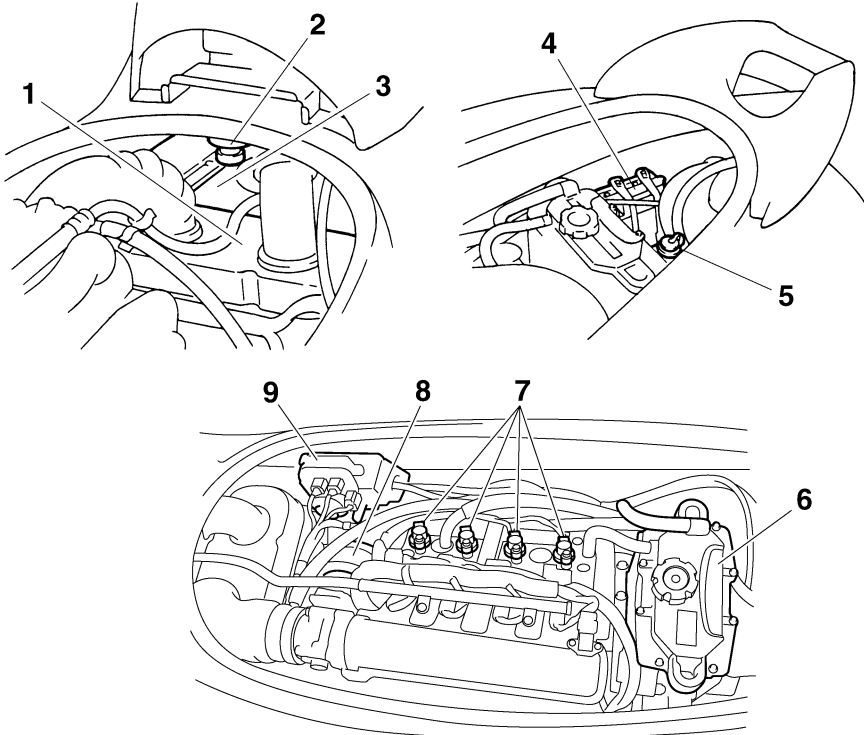

- 1 Air filter case
- 2 Water separator
- 3 Fuel tank
- 4 Battery
- 5 Flushing hose connector
- 6 Oil tank
- 7 Spark plugs/Spark plug caps/Ignition coils
- 8 Muffler
- 9 Electrical box

Features and functions

EJU31020

Operation of controls and other functions

EJU31031

Seat

There is a seat latch at the rear of the seat to remove the seat.

To remove the seat:

Pull the seat latch up, and then pull the seat off.

VX/VX Deluxe

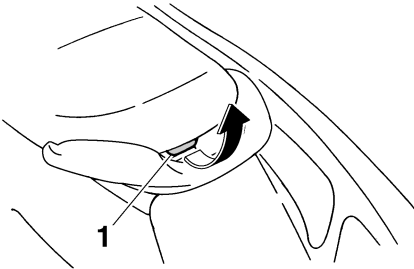

1 Seat latch

VX Cruiser

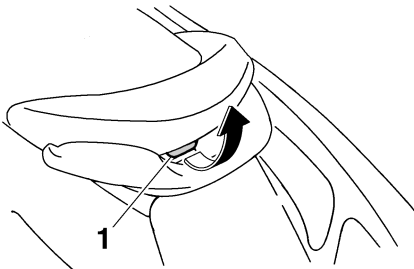

1 Seat latch

To install the seat:

Insert the projection on the front of the seat into the stay on the deck, and then push the

rear of the seat down to lock it in place securely.

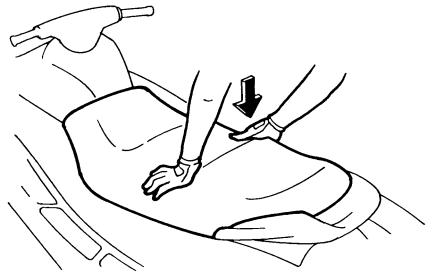
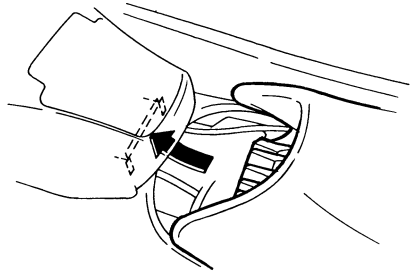

NOTE:

Make sure that the seat is securely installed before operating the watercraft.

EJU31071

Hood

To open the hood, pull the hood latch up, and then lift up the hood.

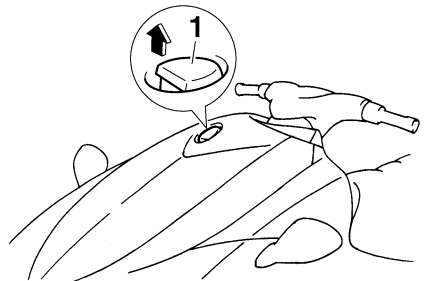

1 Hood latch

Features and functions

To close the hood, push the hood down to lock it in place.

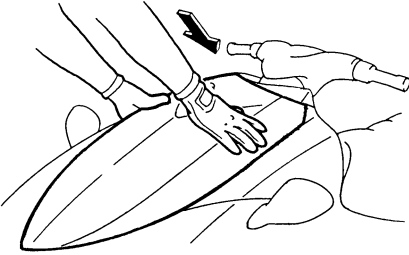

NOTE:

Make sure that the hood is securely closed before operating the watercraft.

EJU31090

Fuel tank filler cap

To remove the fuel tank filler cap, turn it counterclockwise.

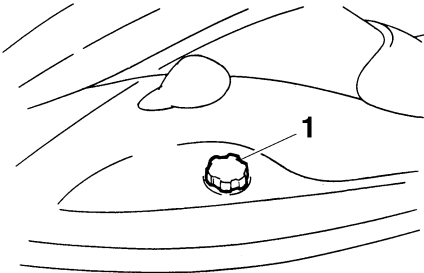

1 Fuel tank filler cap

NOTE:

Make sure that the fuel tank filler cap is securely closed before operating the watercraft.

EJU36620

Remote control transmitter (for VX Deluxe/VX Cruiser)

The Yamaha Security System and low-RPM mode settings are selected using the remote control transmitter. (See “Yamaha Security System and low-RPM mode” on page 29 for

information on using the remote control transmitter.)

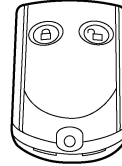

EGJ00020

CAUTION:

The Yamaha Security System and low-RPM mode settings can only be selected using the remote control transmitter. Observe the following precautions to protect your remote control transmitter:

- Store the remote control transmitter carefully so it will not be lost. When operating the watercraft, use the transmitter holder in the glove compartment. If you accidentally lose your remote control transmitter, contact a Yamaha dealer.
- While the remote control transmitter has been designed for use in wet environments, it should not be operated underwater or submerged for an extended length of time. If it gets wet, dry it with a soft, dry cloth.
- Keep the remote control transmitter away from high temperatures and do not place it in direct sunlight.
- Do not drop the remote control transmitter, subject it to strong shocks, or place any heavy items on it.
- Use a soft, dry cloth to clean the transmitter. Do not use detergent, alcohol, or other chemicals.

Features and functions

- If the remote control transmitter needs a new battery or is not operating properly, contact a Yamaha dealer. Do not attempt to replace the battery yourself.

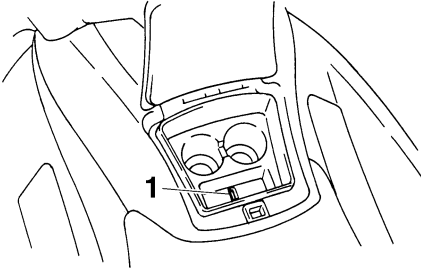

1 Transmitter holder

NOTE:

- While the engine is running, input from the remote control transmitter is not received.
- Refer to local hazardous waste regulations when disposing of transmitter batteries.

EJU31150

Engine stop switch

Push the engine stop switch (red button) to stop the engine normally.

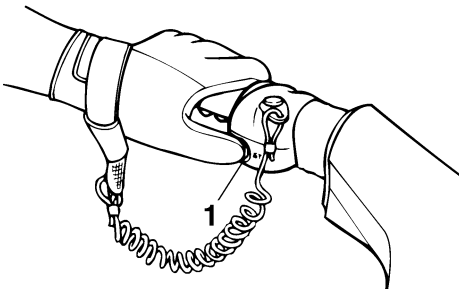

1 Engine stop switch

EJU31160

Engine shut-off switch

Insert the clip, on the end of the engine shut-off cord, under the engine shut-off switch (black button). The engine will stop automatically when the clip is removed from the

switch, such as if the operator falls off the watercraft.

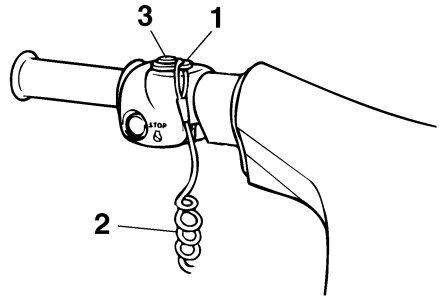

- 1 Clip
- 2 Engine shut-off cord
- 3 Engine shut-off switch

EWJ00010

WARNING

- Always attach the engine shut-off cord to your left wrist and the clip to the engine shut-off switch BEFORE starting the engine.
- To prevent accidental starting of the engine or unauthorized use by children or others, always remove the clip from the engine shut-off switch when the engine is not running.

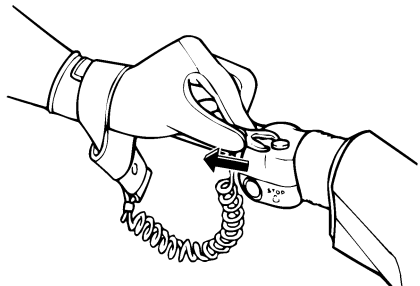

Features and functions

EJU31191

Start switch

Push the start switch (green button) to start the engine.

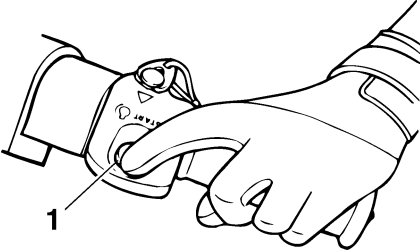

1 Start switch

NOTE:

The engine will not start when the lock mode of the Yamaha Security System has been selected (for VX Deluxe/VX Cruiser), the clip is removed from the engine shut-off switch, or the throttle lever is squeezed. (See page 29 for Yamaha Security System lock and unlock mode selection procedures.)

EJU31210

Throttle lever

Squeeze the throttle lever to increase engine speed.

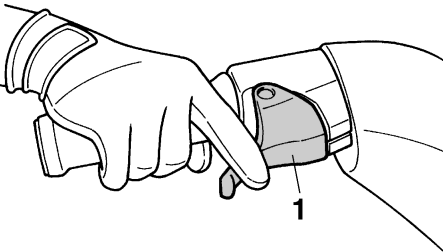

1 Throttle lever

Release the throttle lever to decrease engine speed or to return it to the idle position.

EJU35971

Cooling water pilot outlet

This watercraft is equipped with a cooling water pilot outlet.

When the engine is running, cooling water is circulated in the engine, and then it is discharged from the pilot outlet.

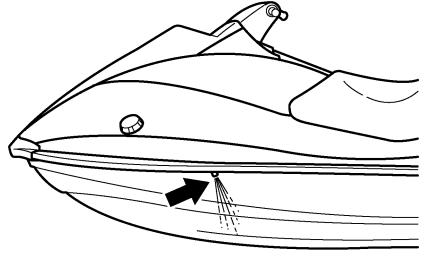

To check for proper operation of the cooling system, check that water is being discharged from the pilot outlet. If water is not being discharged from the outlet, cooling water may not be circulating in the engine. When this occurs, stop the engine and check for the cause. (See pages 33 and 80 for more information.)

NOTE:

- If the cooling water passages are dry, it will take about 60 seconds for the water to reach the outlet after the engine is started.
- Water discharge may not be constant at idle, therefore, open the throttle a little to check that water discharges properly.

Features and functions

EJU31260

Steering system

Your watercraft can be steered by turning the handlebars in the direction you wish to travel.

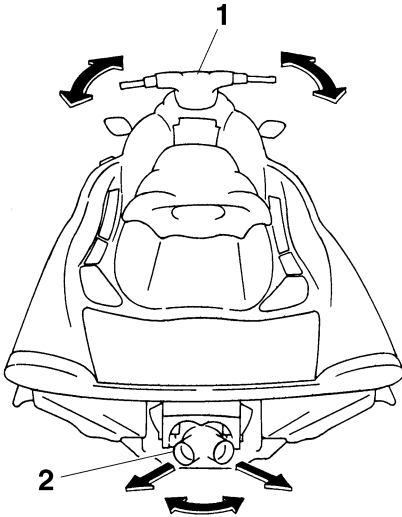

- 1 Handlebar
- 2 Jet thrust nozzle

When the handlebars are turned, the angle of the jet thrust nozzle is changed, and the direction of the watercraft is changed accordingly. Since the strength of the jet thrust determines the speed and degree of a turn, throttle must always be applied when attempting a turn, except at trolling speed.

This model is equipped with the Yamaha Engine Management System (YEMS) that includes an off-throttle steering (OTS) system. It will activate at planing speeds should you attempt to steer the watercraft after releasing the throttle lever. The OTS system assists in turning by continuing to supply some thrust while the watercraft is decelerating, but you

can turn more sharply if you apply throttle while turning the handlebars.

The OTS system does not function below planing speeds or when the engine is off. Once the engine slows down, the watercraft will no longer turn in response to handlebar input until you apply throttle again or you reach trolling speed.

EJU31300

Shift lever (for VX Deluxe/VX Cruiser)

The shift lever is located on the starboard (right) side of the watercraft and is used to control the reverse gate, which allows the watercraft to move in reverse or forward.

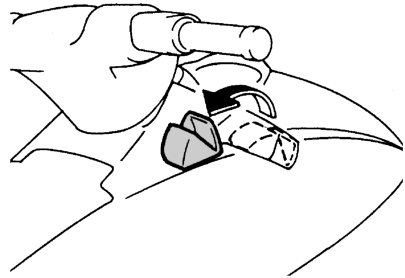

When the shift lever is in the reverse position, the watercraft can be launched from a trailer, or backed up out of tight spots where you cannot turn around easily.

To shift into reverse:

- (1) Release the throttle lever and let the engine speed return to idle.
- (2) Pull the shift lever toward you.

EWJ00030

! WARNING

- **Make sure that the throttle lever is completely released and that the engine is at idle before shifting into reverse.**
- **Do not use the reverse function to slow down or stop the watercraft as it could cause you to lose control, be ejected, or impact the handlebars.**

Features and functions

- Use reverse for slow-speed maneuvering only.
- Make sure that there are no obstacles or people behind you before shifting into reverse.
- Do not touch the reverse gate while the shift lever is being operated, otherwise you could be pinched.

To shift into forward:

- (1) Release the throttle lever and let the engine speed return to idle.
- (2) Push the shift lever away from you.

EJU31360

Handgrip

The handgrip provides a handhold for boarding the watercraft and for a spotter when facing rearward.

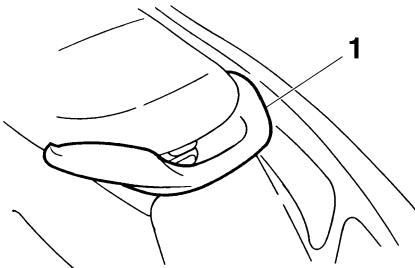

1 Handgrip

EWJ00020



Do not use the handgrip to lift the watercraft. The watercraft could fall, which could result in severe injury.

EJU34870

Bow eye

The bow eye is located at the bow of the watercraft.

The bow eye is used to attach a rope to the watercraft when transporting, mooring, or towing it in an emergency.

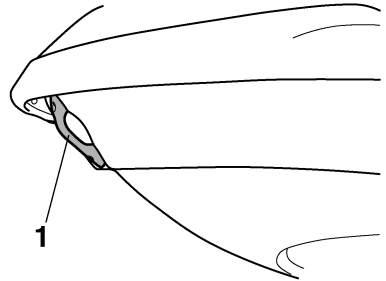

1 Bow eye

EJU34880

Stern eyes

The stern eyes are located at the stern of the watercraft.

The stern eyes are used to attach a rope to the watercraft when transporting or mooring it.

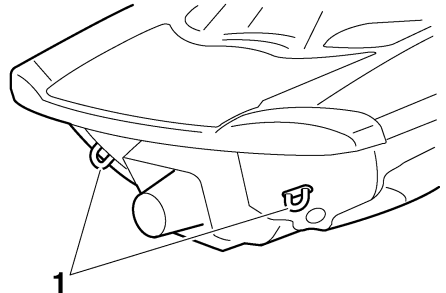

1 Stern eye

EJU31370

Yamaha Engine Management System (YEMS)

This model is equipped with an integrated, computerized management system that controls and adjusts ignition timing, fuel injection, engine diagnostics, and the off-throttle steering (OTS) system.

Features and functions

EJU31380

Yamaha Security System and low-RPM mode (for VX Deluxe/VX Cruiser)

This watercraft is equipped with a remote control transmitter that is used to select the security system and low-RPM mode settings. Since the watercraft is programmed to recognize the internal code from this transmitter only, the security system setting can only be changed with this transmitter. If you lose the remote control transmitter or it does not operate properly, contact a Yamaha dealer.

EJU31390

Yamaha Security System (for VX Deluxe/VX Cruiser)

The Yamaha Security System functions to help prevent unauthorized use or theft of the watercraft. The engine cannot be started if the security system is in the lock mode. The engine can only be started in the unlock mode.

EJU36102

Yamaha Security System lock and unlock modes (for VX Deluxe/VX Cruiser)

The lock and unlock modes of this system can only be selected while the engine is stopped. When the lock button on the remote control transmitter is pressed, the beeper sounds once. This indicates the lock mode is selected and the engine cannot be started.

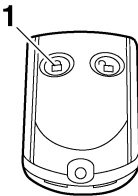

1 Lock button

The “SECURITY” indicator light comes on when the security system is in the unlock

mode and goes off when the security system is in the lock mode.

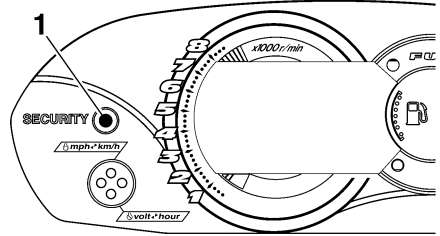

1 “SECURITY” indicator light

When the unlock button on the remote control transmitter is pressed for a short time, the beeper sounds two times for the normal mode or three times for the low-RPM mode. The “SECURITY” indicator light will come on and the engine can be started. (See the items in “Selecting the normal mode/low-RPM mode” for operation mode information.)

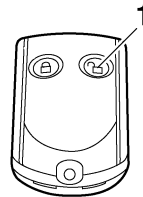

1 Unlock button

Number of beeps	Yamaha Security System mode	Engine can be started
1 beep	Lock	NO
2 beeps	Unlock (normal mode)	YES
3 beeps	Unlock (low-RPM mode)	YES

Features and functions

EJU31412

Selecting the normal mode/low-RPM mode (for VX Deluxe/VX Cruiser)

The normal mode and low-RPM mode can only be selected when the engine is stopped in the unlock mode. Press the unlock button on the remote control transmitter for more than 4 seconds to switch between the normal mode and the low-RPM mode.

Normal mode

If the beeper sounds twice, the normal mode is activated.

The watercraft can be ridden normally.

Low-RPM mode

If the beeper sounds three times, the low-RPM mode is activated and the “L-MODE” indicator light comes on.

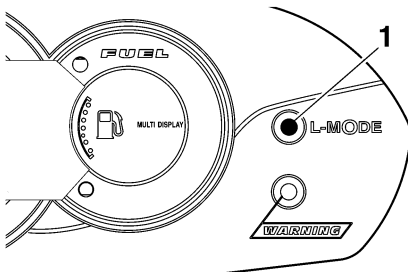

1 “L-MODE” indicator light

Maximum engine speed (r/min) in the low-RPM mode is limited to approximately 90% of the maximum engine speed in the normal mode.

NOTE:

- If neither the start switch nor the remote control transmitter is operated within 25 seconds after the unlock button is pressed to select the unlock mode, the multifunction information center display and the “L-MODE” indicator light will go off. If this occurs, press the lock button on the transmitter briefly to select the lock mode, press the unlock button briefly to select the unlock

mode, and then press the unlock button again for more than 4 seconds to select the normal mode or low-RPM mode.

- While the engine is running, input from the remote control transmitter is not received.

ECJ00080

CAUTION:

If the remote control transmitter does not operate when its buttons are pressed, the battery may be low. Have a Yamaha dealer replace the battery.

EJU31452

Multifunction information center

This meter contains the following functions for help and convenience in operating the watercraft.

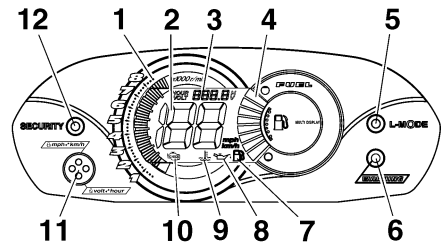

- 1 Tachometer
- 2 Speedometer
- 3 Hour meter/voltmeter
- 4 Fuel level meter
- 5 “L-MODE” indicator light (for VX Deluxe/VX Cruiser)
- 6 “WARNING” light
- 7 Fuel level warning indicator
- 8 Oil pressure warning indicator
- 9 Engine overheat warning indicator
- 10 Check engine warning indicator
- 11 Select button
- 12 “SECURITY” indicator light (for VX Deluxe/VX Cruiser)

Features and functions

ECJ00072

CAUTION:

Do not run the engine for more than 15 seconds without supplying water or over 4000 r/min when checking the operation of the meter on land, otherwise the engine could overheat.

NOTE:

- When the engine is started, all displays light up for 2 seconds, and then the meter starts to operate normally.
- The current display will continue to operate for 25 seconds after the engine stops.

EJU31461

Tachometer

The engine speed (r/min) is displayed by segments. Each segment indicates a 250 r/min increment.

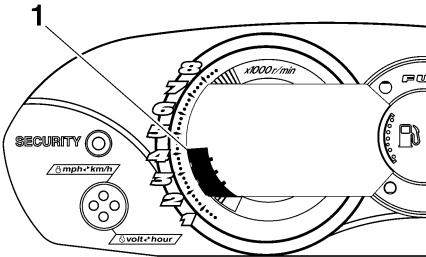

1 Tachometer

EJU31500

Speedometer

The meter shows the watercraft speed against water.

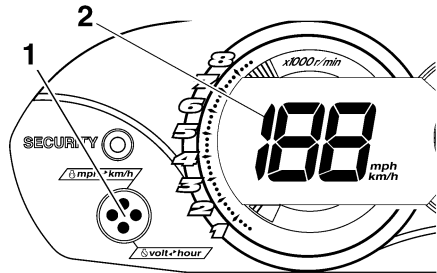

- 1 Select button
- 2 Speedometer

NOTE:

To switch the speedometer display between kilometers and miles, push the select button for at least 1 second, within 10 seconds after the meter is displayed.

EJU31511

Fuel level meter

The fuel level meter is provided for convenient fuel level checking while riding.

The fuel level meter has eight segments which show the amount of fuel remaining in the fuel tank.

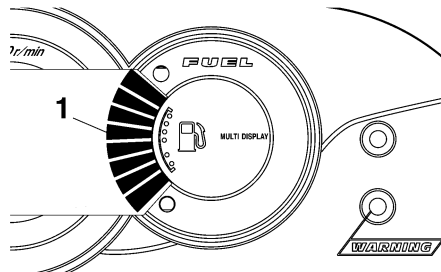

1 Fuel level meter

Features and functions

NOTE:

The fuel level is most accurate when the watercraft is sitting level on a trailer or in the water.

EJU31551

Hour meter/voltmeter

NOTE:

To switch the display between the hour meter and the voltmeter, push the select button for at least 1 second after the meter is displayed for more than 10 seconds.

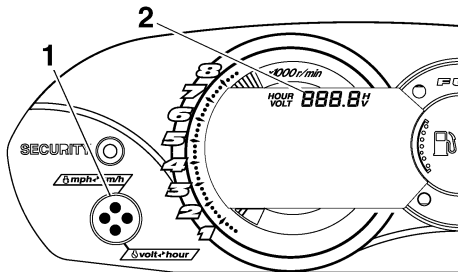

- 1 Select button
- 2 Hour meter/voltmeter

Hour meter

The hour meter is provided to make it easy to follow the maintenance schedule.

The meter shows the hours of engine operation that have elapsed since the watercraft was new.

Voltmeter

The voltmeter is provided to display the voltage of the battery.

When the battery voltage is normal, the voltmeter displays approximately 12 volts.

If the battery voltage is less than 8.0 volts, "LO" is displayed on the voltmeter and if the voltage is above 18.1 volts, "HI" is displayed on the voltmeter. If "HI" or "LO" is displayed, return to shore and, if necessary, have a

Yamaha dealer check the charging system and the battery.

EJU31560

Fuel level warning indicator

If the fuel remaining in the fuel tank drops to about 13 L (3.4 US gal, 2.9 Imp gal), the lowest two fuel level segments, the fuel level warning indicator, and the "WARNING" light begin to blink. The buzzer also starts sounding intermittently.

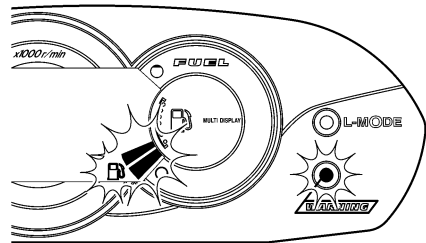

If this occurs, refill the fuel tank as soon as possible.

The warning signals will be cleared when the engine is restarted after the fuel tank is refilled.

EJU31622

Oil pressure warning indicator

If the oil pressure does not rise to specification, the "WARNING" light and the oil pressure warning indicator begin to blink, and the buzzer sounds intermittently. At the same time, the engine speed is limited to help prevent damage.

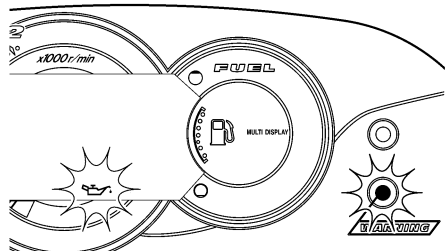

Features and functions

If this occurs, reduce the engine speed, return to shore, and then check the engine oil level. (See page 42 for engine oil level checking procedures.) If the oil level is low, add enough engine oil to raise it to the proper level. If the oil level is sufficient, have a Yamaha dealer check the watercraft.

NOTE:

Press the select button on the multifunction information center to stop the buzzer.

engine speed is limited to help prevent damage.

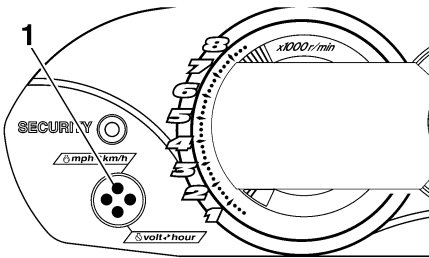
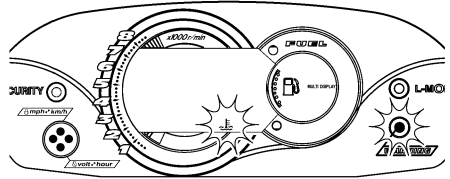

1 Select button

EJU31604

Engine overheat warning indicator

This model is equipped with an engine overheat warning system.

If the engine starts to overheat, the “WARNING” light and the engine overheat warning indicator blink, and then come on. The buzzer also begins to sound intermittently, and then it sounds continuously. After the light and indicator start to blink and the buzzer sounds, the

If this occurs, immediately reduce the engine speed, return to shore, and then check for water discharge at the port (left) cooling water pilot outlet while the engine is running. If there is no discharge of water, shut the engine off, and then check the intake grate and impeller for clogging.

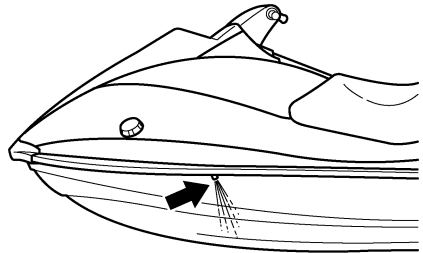

EWJ00050

WARNING

Before attempting to remove weeds or debris from the intake grate or impeller, shut the engine off and remove the clip from the engine shut-off switch. Severe injury or

Features and functions

death could result from coming in contact with the rotating parts of the jet pump.

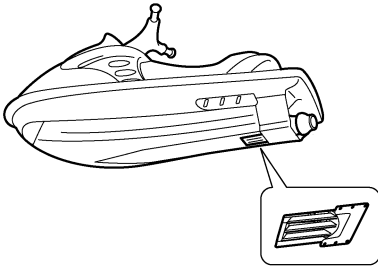
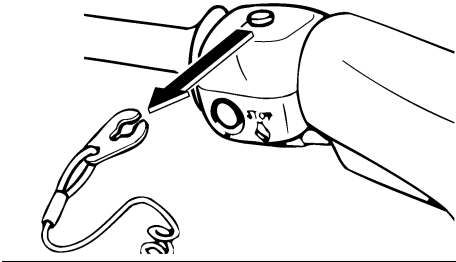

ECJ00040

CAUTION:

If you cannot locate and correct the cause of the overheating, consult a Yamaha dealer. Continuing to operate at higher speeds could result in severe engine damage.

NOTE: Press the select button on the multifunction information center to stop the buzzer.

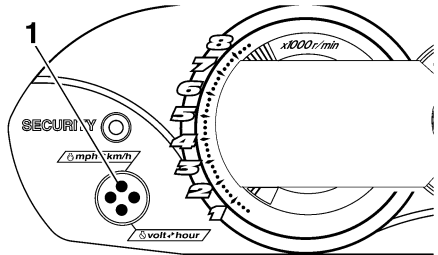

1 Select button

EJU31630

Check engine warning indicator

If a sensor malfunction or a short circuit is detected, the "WARNING" light and the check engine warning indicator begin to blink, and the buzzer sounds intermittently.

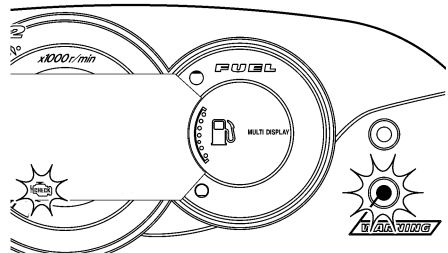

If this occurs, reduce the engine speed, return to shore, and have a Yamaha dealer check the engine.

EJU35001

"SECURITY" indicator light (for VX Deluxe/VX Cruiser)

The "SECURITY" indicator light comes on when the unlock mode of the Yamaha Security System is selected. The watercraft can be

Features and functions

ridden normally when this light is on. (See page 29 for more information.)

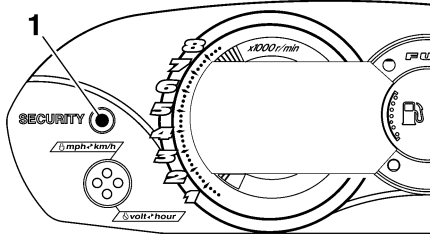

1 "SECURITY" indicator light

EJU35010

"L-MODE" indicator light (for VX Deluxe/VX Cruiser)

The "L-MODE" indicator light comes on when the low-RPM mode is selected. (See page 30 for more information.)

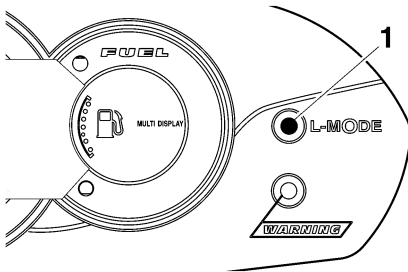

1 "L-MODE" indicator light

EJU31680

Storage compartments

A front storage compartment and a glove compartment are provided.

NOTE:

- Make sure that the storage compartments are securely closed before operating the watercraft.
- The storage compartments are not designed to be waterproof. If you carry objects that must be kept dry, such as the manuals, put them in a waterproof bag.

EJU31711

Front storage compartment

The front storage compartment is located at the bow.

To open the front storage compartment, pull the hood latch up, and then lift up the hood.

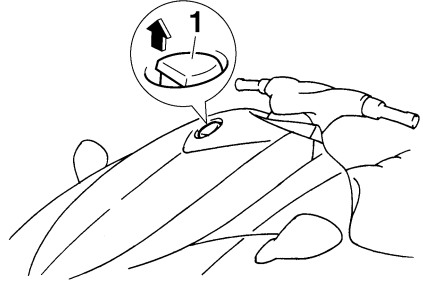

1 Hood latch

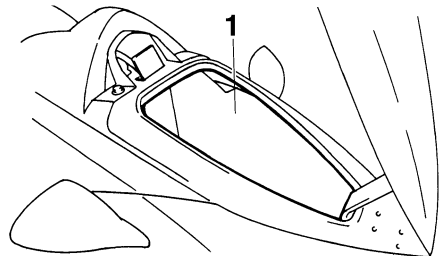
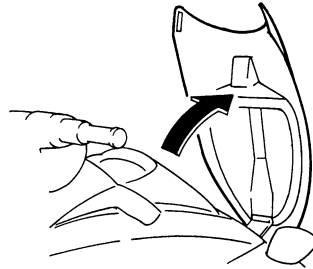

1 Front storage compartment

Features and functions

Front storage compartment:

Capacity:

62.0 L (16.4 US gal) (13.6 Imp.gal)

Load limit:

5.0 kg (11 lb)

To close the front storage compartment, push down on the rear of the hood until it latches securely.

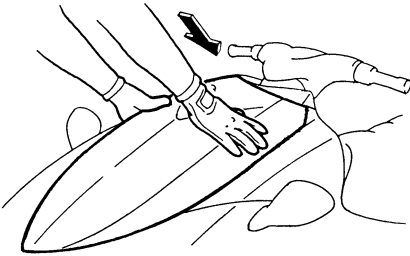

NOTE:

Make sure that the hood is securely closed before operating the watercraft.

EJU31752

Glove compartment

The glove compartment is located in front of the seat.

To open the glove compartment, slide the glove compartment latch toward you, and then lift up the lid.

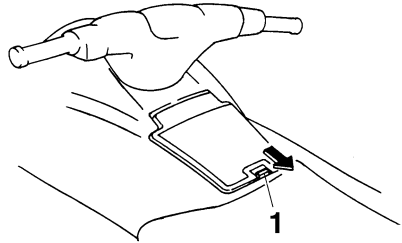

1 Glove compartment latch

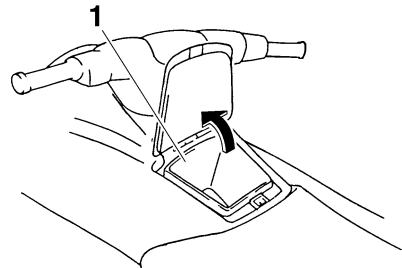

1 Glove compartment

Glove compartment:

Capacity:

5.2 L (1.4 US gal) (1.1 Imp.gal)

Load limit:

1.0 kg (2 lb)

To close the glove compartment, push the lid down until it latches securely.

For VX Deluxe/VX Cruiser:

A removable beverage holder, which includes a transmitter holder, is provided in the glove compartment.

NOTE:

- Do not place beverages in the beverage holder when operating the watercraft.

Features and functions

- Keep the remote control transmitter in the transmitter holder when operating the watercraft.
-

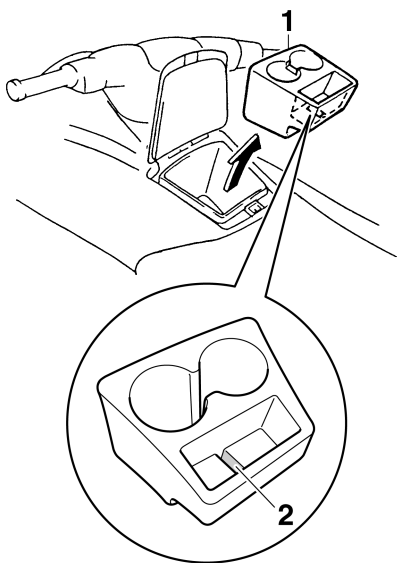

- 1 Beverage holder
- 2 Transmitter holder

EJU31820

Fuel and oil

This watercraft is equipped with a 4-stroke engine. Conventional 2-stroke engine oil cannot be used.

The engine utilizes an electronic fuel injection system to deliver the optimal air-fuel ratio required by the engine. By ensuring the optimal combustion conditions, this system is able to increase startability and improve fuel economy.

EJU31841

Gasoline

EWJ00280



GASOLINE AND ITS VAPORS ARE HIGHLY FLAMMABLE AND EXPLOSIVE!

- Do not smoke when refueling, and keep away from sparks, flames, and other sources of ignition.
- Stop the engine before refueling.
- Refuel in a well-ventilated area with the watercraft in a horizontal position.
- Do not stand or sit on the watercraft while refueling in case of fire.
- Take care not to spill gasoline. If gasoline spills, wipe it up immediately with dry rags. Always properly dispose of gasoline-soaked rags.
- Avoid overfilling the fuel tank. Stop filling when the fuel level reaches approximately 50 mm (2 in) from the top of the fuel tank. Fuel expands as it warms up and could overflow if the fuel tank has been overfilled. If temporarily leaving the watercraft with a full fuel tank, do not leave it in direct sunlight. Leave it in a well-ventilated area with the watercraft in a horizontal position.
- Tighten the fuel tank filler cap securely after refueling.

- If you should swallow some gasoline, inhale a lot of gasoline vapor, or get gasoline in your eyes, get immediate medical attention.
- If any gasoline spills on your skin or clothing, immediately wash the affected area with soap and water and change your clothes.

ECJ00310

CAUTION:

Use only fresh gasoline that has been stored in clean containers.

Recommended gasoline:

Regular unleaded gasoline with a minimum octane rating of
 $86 \text{ (Pump octane number)} = (R + M)/2$
90 (Research octane number)

EJU31860

Gasohol

There are two types of gasohol: gasohol containing ethanol and that containing methanol. Gasohol containing ethanol can be used if ethanol content does not exceed 10% and the fuel meets the minimum octane ratings.

Gasohol containing methanol is not recommended by Yamaha because it can cause fuel system damage and engine performance problems.

Operation

EJU31890

Engine oil

Use a combination of the recommended SAE and API engine oil classifications shown in the chart below.

SAE				API
-4	32	68	104 °F	SE
-20	0	20	40 °C	SF
10W-30				SG
20W-40				SH
20W-50				SJ
				SL

ECJ00280

CAUTION:

Use only 4-stroke engine oil.

EJU31931

Filling the fuel tank

ECJ00290

CAUTION:

Be careful when refueling. Avoid getting water and other contaminants in the fuel tank. Contaminated fuel can cause poor running and engine damage.

- (1) Remove the seat. (See page 23 for seat removal and installation procedures.)
- (2) Remove the fuel tank filler cap, and then slowly add fuel to the fuel tank. Stop filling when the fuel level reaches approximate-

ly 50 mm (2 in) from the top of the fuel tank as indicated in the illustration.

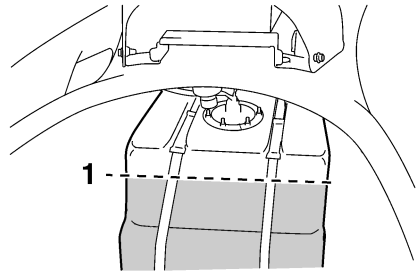
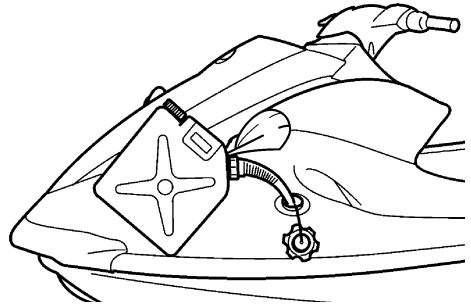

- 1 Approximately 50 mm (2 in) from top of the fuel tank
- (3) Install the fuel tank filler cap and the seat.

Fuel tank capacity:
60 L (15.9 US gal) (13.2 Imp.gal)

EJU31980

Pre-operation checks

EJU31990

Pre-operation check list

Before operating this watercraft, perform the checks in the following check list. See the accompanying text in this chapter for details on how to perform the checks.

EWJ00410



If any item in the pre-operation check list is not working properly, have it inspected and repaired before operating the watercraft, otherwise an accident could occur.

ITEM	ROUTINE	PAGE
BEFORE LAUNCH OR OPERATION		
Engine compartment	Remove the seat to ventilate the engine compartment. Check for fuel vapors and loose electrical connections.	42
Bilge	Check for water and fuel and drain if necessary.	43
Stern drain plugs	Check for proper installation.	44
Throttle lever	Check that the throttle lever springs back smoothly.	45
Steering system	Check for proper operation.	45
Shift lever and reverse gate (VX Deluxe/VX Cruiser)	Check for proper operation.	46
Fuel and oil	Check the fuel and oil levels and replenish if necessary. Check the hoses and tanks for leakage.	42, 42
Water separator	Check for water and drain if necessary.	43
Battery	Check the electrolyte level and battery condition.	44
Hood	Check that the hood is securely closed.	23
Seat	Check that the seat is securely installed.	23
Hull and deck	Check the hull and deck for cracks and other damage.	42
Jet intake	Check for debris and remove if necessary.	47
Fire extinguisher	Check the condition and replace if necessary.	45
Engine shut-off cord	Check the condition and replace if frayed or broken.	47
Switches	Check the start switch, engine stop switch, and engine shut-off switch for proper operation.	48
AFTER LAUNCH		
Cooling water pilot outlet	Check that water is discharged while the engine is running and the watercraft is in the water.	48
Multifunction information center	Check for warning indications and proper operation.	48

Operation

NOTE: _____

Pre-operation checks should be made each time the watercraft is used. These checks can be completed in a short time. It is worth the time spent to ensure safety and reliability.

EJU32280

Pre-operation check points

EJU32310

Engine compartment

Ventilate the engine compartment before each use.

To ventilate the engine compartment, remove the seat. (See page 23 for seat removal and installation procedures.) Leave the engine compartment open for a few minutes to allow any fuel vapors to escape.

While the engine compartment is open, check for loose electrical connections.

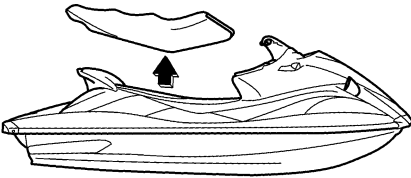

EWJ00460

WARNING

Failure to ventilate the engine compartment could result in a fire or explosion. Do not start the engine if there is a fuel leak or a loose electrical connection.

EJU32350

Hull and deck

Check the hull and deck for cracks and other damage. If any damage is found, have a Yamaha dealer repair the watercraft.

EJU32390

Fuel level

Check the fuel system for leakage, cracks, and malfunctions before each use. (See page 70 for check points and correct procedures.)

- (1) Remove the fuel tank filler cap to release any pressure that might have built up in the fuel tank.

- (2) Remove the seat. (See page 23 for seat removal and installation procedures.)
- (3) Check the fuel level in the fuel tank and replenish if necessary. (See page 39 for filling procedures.)
- (4) Install the fuel tank filler cap and the seat.

EJU32400

Engine oil level

Check the engine oil level before each use.

ECJ00390

CAUTION:

- When checking the engine oil level on water, be careful of other watercraft, boats, swimmers, and obstacles. The water current and wind can cause the watercraft to move and lead to a collision.
- When checking the engine oil level on land, supply water to the cooling water passages. (See page 63 for procedures on supplying water.)
- Make sure that the engine has enough oil, but do not overfill it. If there is too little oil, the engine can be damaged. If there is too much oil, the air filter can become saturated with oil, permanently damaging the filter and reducing engine performance. Follow the checking procedure carefully.
- Make sure that debris and water do not enter the oil tank filler hole. Debris and water in the engine oil can cause serious engine damage.

To check the engine oil level:

- (1) Place the watercraft in a horizontal position or launch the watercraft, and then start the engine.
- (2) Run the engine at trolling speed for 6 minutes or more, and then stop the engine.

Operation

NOTE:

If the ambient temperature is 20 °C (68 °F) or less, warm up the engine for an additional 5 minutes.

- (3) Remove the seat. (See page 23 for seat removal and installation procedures.)
- (4) Remove the oil tank filler cap, wipe the dipstick clean, and then screw the filler cap into the filler hole completely. Remove the filler cap again and check that the engine oil level is between the minimum level mark and maximum level mark on the dipstick.

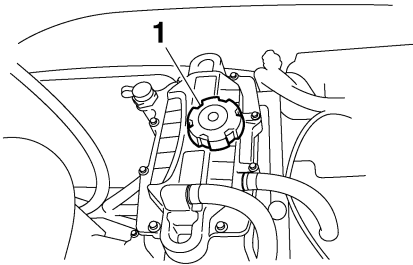

1 Oil tank filler cap

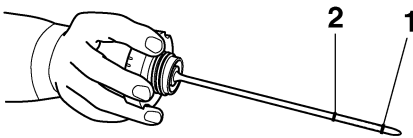

- 1 Minimum level mark
- 2 Maximum level mark

- (5) If the engine oil level is below the minimum level mark, add enough oil so that the oil level is between the minimum and maximum level marks on the dipstick,

and then install the filler cap. If the engine oil level is significantly above the maximum level mark, the oil tank is overfilled. Have a Yamaha dealer remove the excessive amount of engine oil.

EJU32420

Water separator

Check the water separator for water. The water separator retains any water that may have entered through the fuel tank breather hose if the watercraft was capsized. Normally, the water separator is empty.

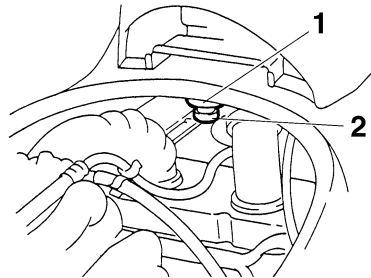

- 1 Water separator
- 2 Drain screw

If water remains in the water separator, drain it by removing the drain screw. Place a drain pan under the water separator to catch the draining water or use a dry cloth to soak up any water that could spill into the watercraft. If any water spills into the watercraft, be sure to wipe it up with a dry cloth. Also, be sure to install the drain screw after draining the water separator.

EJU32460

Bilge

Check the bilge for moisture and fuel residue.

ECJ00370

CAUTION:

Excessive water in the bilge can splash into the engine, which can result in severe damage.

To drain water from the bilge:

- (1) Remove the stern drain plugs.
- (2) Raise the bow of the watercraft until the water drains.
- (3) After the water has drained, wipe the bilge with dry rags to make sure that it is thoroughly dry.
- (4) Install the stern drain plugs.

ECJ00360

CAUTION:

- Before installing the stern drain plugs, clean the drain plug threads to remove any foreign materials, such as dirt or sand. Otherwise, the stern drain plugs could be damaged, allowing water to enter the engine compartment.
- Make sure that the stern drain plugs are tightened securely before launching the watercraft. Otherwise, water may flood the engine compartment and cause the watercraft to submerge.

EJU32470

Stern drain plugs

Check the stern drain plugs for proper installation.

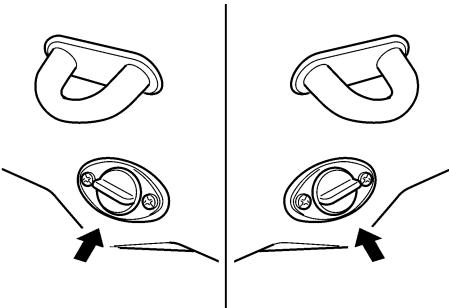

ECJ00360

CAUTION:

- Before installing the stern drain plugs, clean the drain plug threads to remove any foreign materials, such as dirt or sand. Otherwise, the stern drain plugs

could be damaged, allowing water to enter the engine compartment.

- Make sure that the stern drain plugs are tightened securely before launching the watercraft. Otherwise, water may flood the engine compartment and cause the watercraft to submerge.

EJU32481

Battery

Check the battery electrolyte level and check that the battery has sufficient power to start the engine easily. Recharge the battery or replace it if it is not in good condition. (See page 74 for battery recharging procedures.)

Also, check that the battery leads are tightened securely and that there is no corrosion on the battery terminals. Check that the breather hose is securely connected to the battery and that it is not pinched.

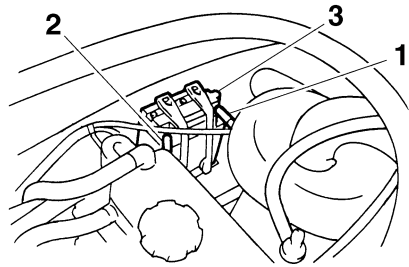

- 1 Positive (+) battery terminal: Red lead
- 2 Negative (-) battery terminal: Black lead
- 3 Breather hose

EWJ00450

WARNING

- The battery must always be fully charged and in good condition. Loss of battery power may leave you stranded. Never operate the watercraft if the battery does not have sufficient power to start the engine or if it shows any other signs of decreased power.

Operation

- Be sure to connect the breather hose to the battery. Fire or explosion could result if the breather hose is damaged, obstructed, or not connected properly.

Make sure that the battery is securely held in place.

EJU32540

Fire extinguisher

Check that there is a full fire extinguisher on board.

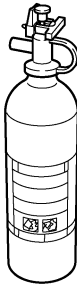

The fire extinguisher holder and cover are located in the front storage compartment.

To store the fire extinguisher, unhook the band and remove the cover. Place the fire extinguisher in the holder, and then place the cover over the fire extinguisher. Fasten the cover and the fire extinguisher with the band securely.

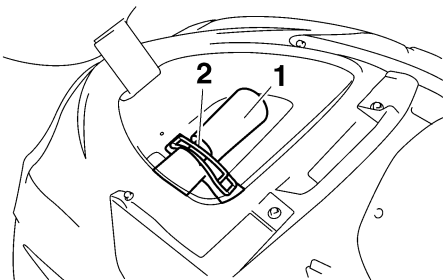

- 1 Fire extinguisher holder and cover
- 2 Band

NOTE:

- To check the fire extinguisher, see the instructions supplied by the fire extinguisher manufacturer. Always keep the fire extinguisher secured in the holder with its cover in place.
- Always carry a fire extinguisher on board. A fire extinguisher is not standard equipment with this watercraft. If you do not have one, contact a Yamaha dealer or a fire extinguisher dealer to obtain one meeting the proper specifications.

EJU32590

Throttle lever

Check the throttle lever for proper operation. Squeeze and release the throttle lever several times to make sure that there is no hesitation in its travel. It should be smooth over the complete range and spring back to the idle position when released.

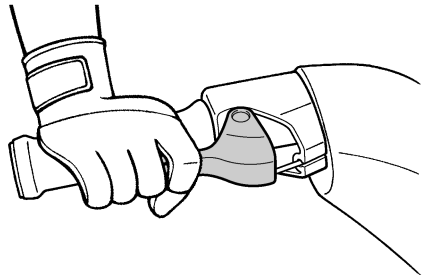

EWJ00490

WARNING

Before starting the engine, always check the operation of the throttle lever.

EJU32600

Steering system

Check the handlebars for looseness.

Turn the handlebars as far as possible to the right and left to make sure that operation is smooth and unrestricted throughout the whole range. Also, make sure that the jet

thrust nozzle moves as the handlebars are turned, and that there is no free play between the handlebars and the jet thrust nozzle.

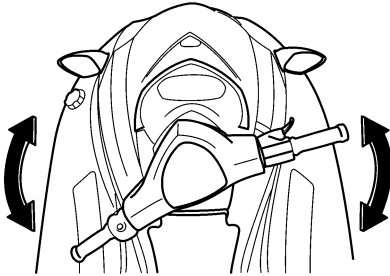

Also, make sure that the reverse gate goes up completely when the shift lever is pushed down.

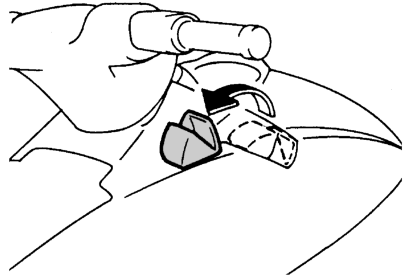

EJU32631

Shift lever and reverse gate (for VX Deluxe/VX Cruiser)

Check the shift lever and reverse gate for proper operation.

Make sure that the reverse gate goes down completely when the shift lever is pulled up.

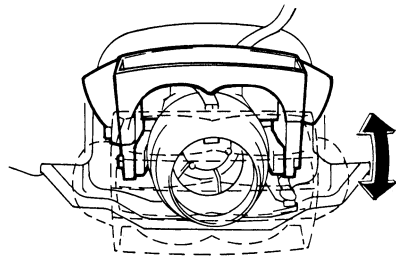

EWJ00030

WARNING

- Make sure that the throttle lever is completely released and that the engine is at idle before shifting into reverse.
- Do not use the reverse function to slow down or stop the watercraft as it could cause you to lose control, be ejected, or impact the handlebars.
- Use reverse for slow-speed maneuvering only.
- Make sure that there are no obstacles or people behind you before shifting into reverse.
- Do not touch the reverse gate while the shift lever is being operated, otherwise you could be pinched.

Operation

EJU32650

Jet intake

Carefully check the jet intake for weeds, debris, or anything else that might restrict the intake of water. If the jet intake is clogged, cavitation could occur, reducing jet thrust, and possibly damaging the jet pump.

In some cases, the engine may overheat because of lack of cooling water, and damage to the engine could result. Cooling water is fed to the engine by the jet pump. (See page 80 for jet intake cleaning procedures.)

EWJ00470

WARNING

- Keep away from the intake grate while the engine is on. Items such as long hair, loose clothing, or PFD straps can become entangled in moving parts, resulting in severe injury or drowning.
- Stop the engine and remove the clip from the engine shut-off switch before removing any debris or weeds, which

may have collected around the jet intake.

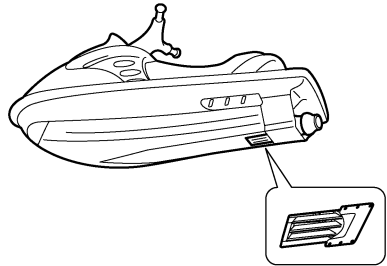
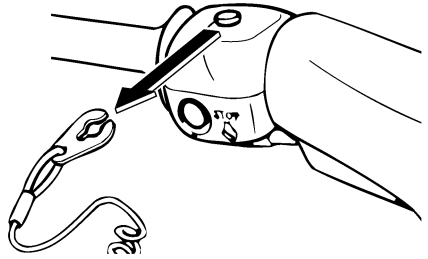

EJU32660

Engine shut-off cord

Check that the engine shut-off cord is not frayed or broken. If the cord is damaged, replace it; never try to repair it or tie it together.

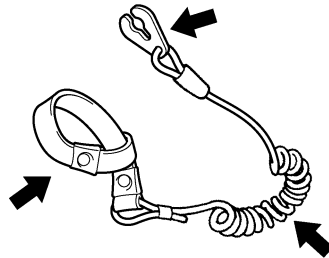

EJU32670

Switches

ECJ00410

CAUTION:

Do not run the engine for more than 15 seconds when checking the switches on land without supplying water, otherwise the engine could overheat.

Check the start switch, the engine stop switch, and the engine shut-off switch for proper operation.

Push the start switch to start the engine. As soon as the engine starts running, push the engine stop switch to verify that the engine stops immediately. Restart the engine, and then pull the engine shut-off cord to remove the clip from the engine shut-off switch to verify that the engine stops immediately. (See pages 25 to 26 for information on proper operation of the start switch, the engine stop switch, and the engine shut-off switch.)

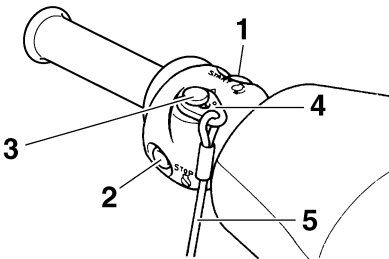

- 1 Start switch
- 2 Engine stop switch
- 3 Engine shut-off switch
- 4 Clip
- 5 Engine shut-off cord

EJU32680

Cooling water pilot outlet

Check that water comes out from the cooling water pilot outlet while the engine is running

and the watercraft is in the water. (See page 26 for more information.)

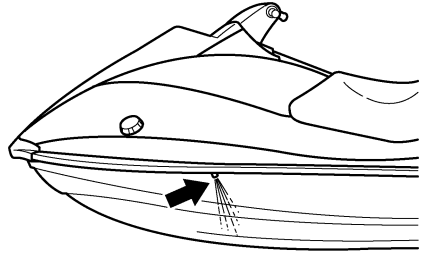

EJU32710

Multifunction information center

Check the multifunction information center for proper operation. (See page 30 for information on proper operation of the multifunction information center.)

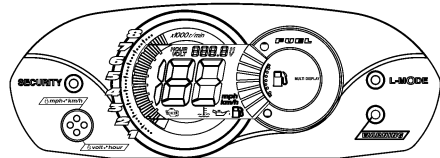

Operation

EJU32740

Operation

EWJ00510

WARNING

Before operating your watercraft, become familiar with all of the controls. Consult a Yamaha dealer about any control or function that you do not fully understand. Failure to understand how the controls work could cause an accident or prevent you from avoiding an accident.

ECJ00460

CAUTION:

Make sure that the stern drain plugs are tightened securely before launching the watercraft.

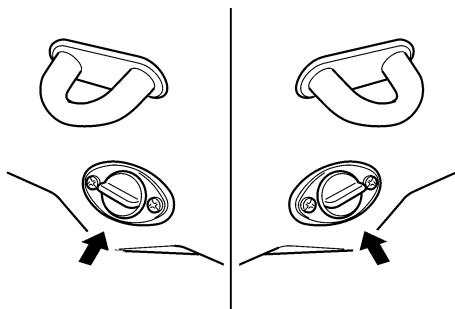

EJU32781

Engine break-in

The engine break-in period is essential to allow the various components of the engine to wear and polish themselves to the correct operating clearances. This ensures proper performance and promotes longer component life.

ECJ00440

CAUTION:

Be sure to check the engine oil level before operating the watercraft for the first time. (See page 42 for engine oil checking procedures.)

- (1) Launch the watercraft and start the engine. (See page 49 for engine starting procedures.)
- (2) For the first 5 minutes, run the engine at trolling speed only. For the 30 minutes of operation after that, keep the engine speed below 5000 r/min. For the 1 hour of operation after that, keep the engine speed below 6500 r/min.
- (3) Proceed with normal operation.

ECJ00430

CAUTION:

Failure to follow the engine break-in procedure could result in reduced engine life or even severe engine damage.

EJU32811

Launching the watercraft

When launching the watercraft, make sure that there are no obstacles around you.

If there are waves, someone should make sure that the watercraft is not pushed into the trailer after launching the watercraft.

- For VX Deluxe/VX Cruiser:
Use the remote control transmitter to select the unlock mode. (See page 29 for Yamaha Security System and low-RPM mode selection procedures.)
After the watercraft is in the water, start the engine. Shift into reverse and move the watercraft back slowly.
- For VX:
After the watercraft is in the water, turn it around so that the bow faces the direction you wish to go. Start the engine, and then slowly move away from the launching area.

EJU32851

Starting the engine

EWJ00560

WARNING

Never start the engine or let it run for any length of time in an enclosed area. Exhaust fumes contain carbon monoxide, a

colorless, odorless gas that may cause loss of consciousness and death within a short time. Always operate the watercraft in an open area.

- (1) If the lock mode of the Yamaha Security System is selected (for VX Deluxe/VX Cruiser), use the remote control transmitter to select the unlock mode. (See page 29 for Yamaha Security System lock and unlock mode selection procedures.)
- (2) Launch the watercraft in water free from weeds and debris and at least 60 cm (2 ft) deep.

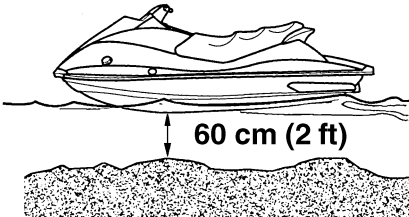

EWJ00570

WARNING

Never operate in water that is less than 60 cm (2 ft) deep, otherwise you increase your chance of hitting a submerged object, which could result in injury.

ECJ00470

CAUTION:

Never operate in water that is less than 60 cm (2 ft) deep, otherwise pebbles or sand could be sucked into the jet intake, causing impeller damage and engine overheating.

- (3) Attach the engine shut-off cord to your left wrist, and then attach the clip to the engine shut-off switch.

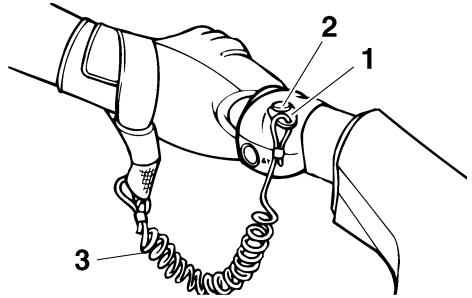

- 1 Clip
- 2 Engine shut-off switch
- 3 Engine shut-off cord

EWJ00580

WARNING

Check that the engine shut-off cord is not frayed or broken, and keep it free from the handlebars so that the engine stops if the operator falls off. The engine shut-off cord may not pull free if wrapped around the handlebars when the operator falls off, allowing the watercraft to continue to run and cause an accident.

NOTE:

It is not possible to start the engine with the clip removed from the engine shut-off switch.

Operation

- (4) Push the start switch (green button), and then release it as soon as the engine starts to run.

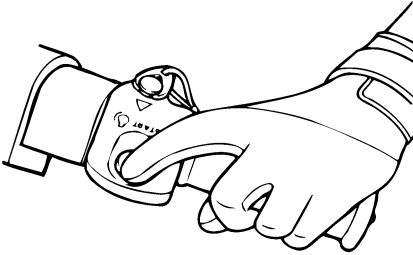

NOTE: _____

The engine will not start if the throttle lever is squeezed.

ECJ00480

CAUTION: _____

- Never push the start switch while the engine is running.
- Do not operate the start switch for more than 5 seconds, otherwise the battery will be discharged and the engine will not start. Also, the starter motor could be damaged. If the engine does not start in 5 seconds, release the start switch, wait 15 seconds, and then try again.

EJU32860

Stopping the engine

To stop the engine, release the throttle lever, and then push the engine stop switch (red button).

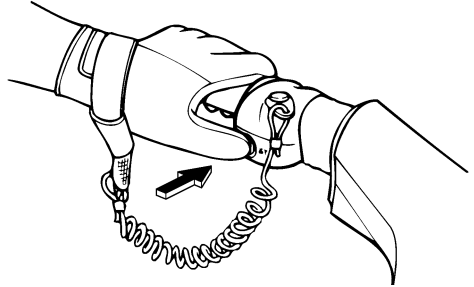

EWJ00600

WARNING _____

You need throttle to steer. Shutting the engine off can cause you to hit an obstacle you are attempting to avoid. A collision could result in severe injury or death.

EJU32890

Leaving the watercraft

If leaving the watercraft, select the lock mode of the Yamaha Security System (for VX Deluxe/VX Cruiser) and remove the engine shut-off cord to reduce the chance of accidental starting or unauthorized use by children or others. (See page 29 for Yamaha Security System and low-RPM mode selection procedures.)

EJU32900

Operating your watercraft

EJU32960

Getting to know your watercraft

Operating your watercraft requires skills acquired through practice over a period of time. Take the time to learn the basic techniques well before attempting more difficult maneuvers.

Operating your new watercraft can be a very enjoyable activity, providing you with hours of pleasure. However, it is essential to familiarize yourself with the operation of the watercraft to achieve the skill level necessary to enjoy riding safely.

Before operating this watercraft, read this owner's/operator's manual, the Riding Practice Guide, and all warning and caution labels on the watercraft. Pay particular attention to the safety information on page 9. These materials should give you an understanding of the watercraft and its operation.

Remember: This watercraft is designed to carry the operator and up to 2 passengers. Never exceed the maximum load limit or allow more than 3 persons (or 2 persons if a water-skier is being pulled) to ride the watercraft at any time.

Maximum load:
240 kg (530 lb)
Load is the total weight of cargo, operator, and passengers.

EJU33000

Learning to operate your watercraft

Before operating the watercraft, always perform the pre-operation checks listed on page 40. The short time spent checking the watercraft will reward you with added safety and reliability.

Check local laws before operating your watercraft.

Operate defensively at safe speeds and keep a safe distance away from people, objects, and other watercraft. Select a wide area to learn in, where there is good visibility and light boat traffic.

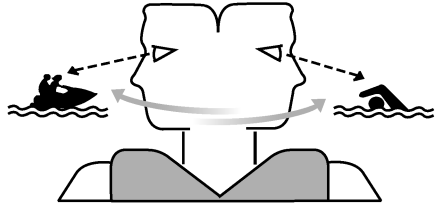

Use the buddy system—operate with someone nearby. Scan constantly for people, objects, and other watercraft. Be alert for conditions that limit your visibility or block your vision of others.

Attach the engine shut-off cord to your left wrist and keep it free from the handlebars so that the engine stops if you, the operator, fall off.

Wear a personal flotation device (PFD). All riders must wear a PFD that is approved by the appropriate authorities and is suitable for personal watercraft use.

Wear protective clothing. Severe internal injuries can occur if water is forced into body cavities as a result of falling into the water or being near the jet thrust nozzle. Normal swimwear does not adequately protect against forceful water entry into the rectum and vagina. All riders must wear a wetsuit bottom or clothing that provides equivalent protection. Such clothing includes thick, tightly woven, sturdy and snug-fitting apparel such as denim, but does not include spandex or similar fabrics, like those used in bicycle shorts. A full wetsuit can also protect against hypothermia

Operation

(subnormal body temperature) and abrasions.

Footwear and gloves are recommended.

Eye protection is recommended to keep wind, water, and glare from the sun out of your eyes while you operate your watercraft. Restraining straps for eyewear are made which are designed to float should your eyewear fall in the water.

You should grip the handlebars firmly and keep both feet on the floor of the footwell. Do not attempt to ride with passengers until your operating skills are fully developed.

EJU33060

Riding with passengers

When 2 or 3 persons (including the operator) are on board, the watercraft handles differently, and is not as easy to maneuver, so operating it requires a higher degree of skill. Before attempting to operate the watercraft with passengers on board, the operator must practice operating the watercraft alone enough to be able to acquire the necessary skills.

The passengers must always wear a PFD that is approved by the appropriate authorities and a wetsuit bottom or equivalent.

EWJ00540

WARNING

Do not apply throttle when anyone is at the rear of the watercraft. Turn the engine off or keep it at idle. Water and/or debris exiting the jet thrust nozzle can cause severe injury. Passengers should not attempt to board the watercraft if the operator is applying throttle.

Do not give a ride to children whose feet cannot reach the floor of the footwell. The passengers should hold on firmly, either to the person in front of them or to the handgrip provided, and keep their feet on the floor of the

footwell. Never allow a passenger to ride in front of the operator.

EWJ00550

WARNING

When passengers are on board, make sure that they are holding on firmly and have their feet on the floor of the footwell before you start to accelerate.

When pulling a water-skier, the spotter should face to the rear while holding the handgrip with both hands. The spotter should always sit astride the seat with both feet placed firmly on the floor of the footwell for proper balance. Follow all local laws regarding water-skiing, such as those for skier-down flags, rearward-facing spotter, and other requirements.

EJU33080

Starting the watercraft

EWJ00710

WARNING

- **Scan constantly for people, objects, and other watercraft. Be alert for conditions that limit your visibility or block your vision of others.**
- **Operate defensively at safe speeds and keep a safe distance away from people, objects, and other watercraft.**
- **Do not follow directly behind watercraft or other boats. Do not go near others to spray or splash them with water. Avoid sharp turns or other maneuvers that make it hard for others to avoid you or understand where you are going. Avoid areas with submerged objects or shallow water.**
- **Take early action to avoid collisions. Remember, watercraft and other boats do not have brakes. Do not release the throttle lever when trying to steer away from objects—you need throttle to steer.**

- Practice reboarding in shallow water before riding in deep water.

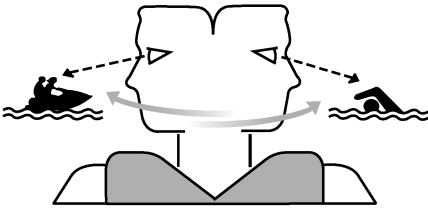

EJU33091

Boarding and starting in shallow water

- (1) Launch the watercraft in water free from weeds and debris and at least 60 cm (2 ft) deep.

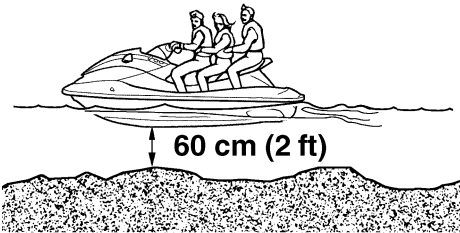

EWJ00570

WARNING

Never operate in water that is less than 60 cm (2 ft) deep, otherwise you increase your chance of hitting a submerged object, which could result in injury.

ECJ00470

CAUTION:

Never operate in water that is less than 60 cm (2 ft) deep, otherwise pebbles or sand could be sucked into the jet intake, causing impeller damage and engine overheating.

- (2) Board the watercraft from the side or the rear.
- (3) Attach the engine shut-off cord to your left wrist, and then attach the clip to the engine shut-off switch.
- (4) Grip the handlebars with both hands, place both feet on the floor of the footwell, start the engine, and then look in all directions before starting off.

EJU33110

Boarding and starting from a dock

- (1) Board the watercraft from the side.
- (2) Attach the engine shut-off cord to your left wrist, and then attach the clip to the engine shut-off switch.
- (3) Push the watercraft away from the dock, grip the handlebars with both hands, place both feet on the floor of the footwell, start the engine, and then look in all directions before starting off.

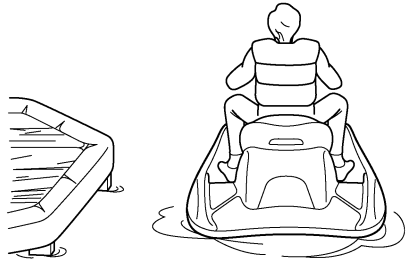

EJU36080

Boarding and starting in deep water

EWJ01110

WARNING

- The operator and passengers should practice boarding in shallow water before riding in deep water. Boarding in deep water requires more skill.
- The fatigue and exposure that could result after unsuccessful attempts to get back on the watercraft may increase the risk of injuries and drowning.

Operation

EJU33140

Boarding alone

- (1) Swim to the rear of the watercraft and place both hands on the boarding platform, pull yourself up, and then grasp the handgrip with one hand.

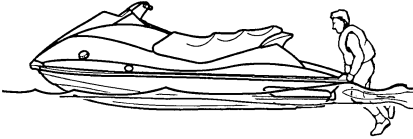

- (2) Pull yourself up to a kneeling position on the platform, and then move to the seat and sit astride.

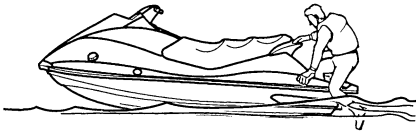

- (3) Attach the engine shut-off cord to your left wrist, and then attach the clip to the engine shut-off switch.
- (4) Grip the handlebars with both hands, place both feet on the floor of the footwell,

start the engine, and then look in all directions before starting off.



EWJ00610

WARNING

Before starting off, make sure that there are no boats, swimmers, or obstacles around you.

EJU33162

Boarding with passengers

EWJ00660

WARNING

Severe internal injuries can occur if water is forced into body cavities as a result of being near the jet thrust nozzle. Do not apply throttle until the passengers are seated with their feet on the floor of the footwell and are securely holding on to the person in front of them or to the handgrip provided.

- (1) Climb on board as noted in the previous section, and sit astride the seat.

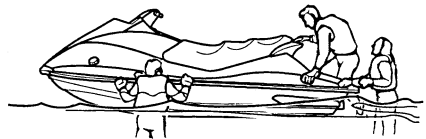

- (2) Attach the engine shut-off cord to your left wrist, and then attach the clip to the engine shut-off switch.
- (3) Have the passengers move to the rear of the watercraft.



- (4) Have a passenger board and sit astride the seat. If a second passenger is boarding, have him or her follow the same procedure.



NOTE: _____
When a passenger is boarding, both the passengers and the operator should try to balance the watercraft.

- (5) Check that the passengers have their feet on the floor of the footwell and are securely holding on to the person in front of them or to the handgrip provided. Nev-

er allow a passenger to ride in front of the operator.



- (6) Start the engine, look in all directions, and then accelerate to planing speed.

EWJ00610

⚠ WARNING

Before starting off, make sure that there are no boats, swimmers, or obstacles around you.

NOTE: _____

The heavier the total weight of the operator and passengers, the more difficult it will be to balance the watercraft. Do not operate the watercraft when the total weight exceeds 240 kg (530 lb) including any cargo. If it is difficult to balance the watercraft at a standstill, proceed as follows:

- (1) While the passengers are steadying the watercraft, pull yourself up onto the boarding platform into a kneeling posi-

Operation

tion, and then move to the seat and sit astride to balance the watercraft.

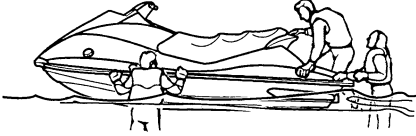

- (2) Have a passenger pull him or herself up onto the boarding platform into a kneeling position, then move to the seat and sit astride to balance the watercraft.
- (3) Attach the engine shut-off cord to your left wrist, and then attach the clip to the engine shut-off switch.
- (4) Start the engine and keep it at idle.
- (5) Have the second passenger pull him or herself up onto the boarding platform into a kneeling position, then crawl onto the seat as the watercraft accelerates.



- (6) Gradually increase the speed to balance the watercraft.



EJU33230

Capsized watercraft

If the watercraft capsizes, turn it over immediately.

Be sure to carefully follow the procedures below to prevent injury, or damage to the watercraft.

EWJ00670

WARNING

IMPROPER UPRIGHTING CAN CAUSE INJURY:

- Be sure to shut the engine off by pulling on the engine shut-off cord to remove the clip from the engine shut-off switch.
- Do not put your hands in the intake grate.

ECJ00530

CAUTION:

If the watercraft capsizes, release the throttle lever immediately. Oil could flow into the air filter case and the engine could be damaged.

- (1) Remove the clip from the engine shut-off switch.
- (2) Swim to the rear of the watercraft. Pull the watercraft over with your left hand on the

ride plate while pushing down on the gunwale with your right hand or foot.

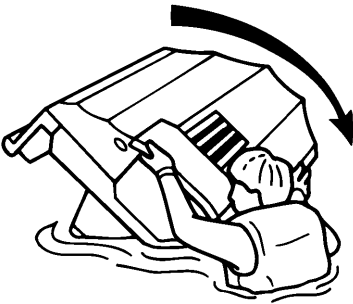
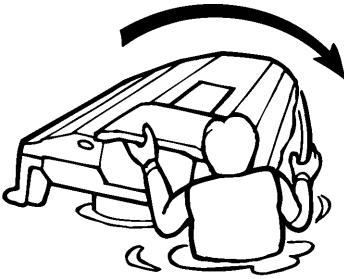

NOTE: _____

If the port (left) side of the capsized watercraft is tilting up, push down on the gunwale so that the port (left) side is down before turning the watercraft clockwise.

ECJ00540

CAUTION: _____

Do not turn the watercraft over counter-clockwise, otherwise water can enter the engine, which can result in severe damage.

- (3) Start the engine and operate the watercraft to discharge any water remaining in the engine compartment. (If the engine does not start, see “Towing the watercraft” on page 83 or “Submerged watercraft” on page 83.)

ECJ00550

CAUTION: _____

Do not operate the engine at full throttle for at least 1 minute after the engine has been restarted. Excessive water in the bilge can splash into the engine, which can result in severe damage.

NOTE: _____

To efficiently discharge water from the engine compartment, operate the watercraft as straight as possible and above planing speed for at least 2 minutes.

EJU33250

Turning the watercraft

Steering control depends on the combination of handlebar position and the amount of throttle.

Water sucked in through the intake grate is pressurized by the impeller in the jet pump. As the pressurized water is expelled from the pump through the jet thrust nozzle, it creates thrust to move and steer the watercraft. The higher the engine speed, the more thrust produced.

The amount of jet thrust, in addition to the position of the handlebars, determines how sharply you turn.

- A. More throttle produces higher thrust, so the watercraft will turn more sharply.

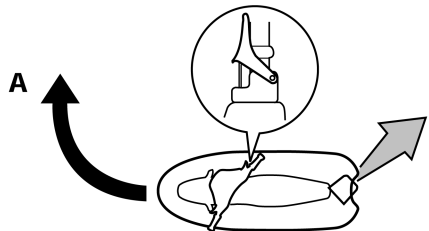

Operation

B. Less throttle produces lower thrust, so the watercraft will turn more gradually.

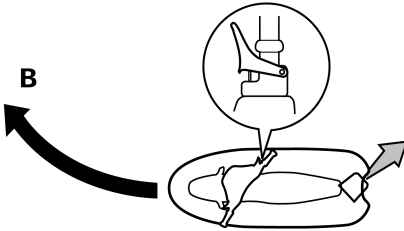

C. Releasing the throttle lever completely produces only minimum thrust. If you are traveling at speeds above trolling, you will have rapidly decreasing ability to steer without throttle. You may still have some turning ability immediately after releasing the throttle lever, but once the engine slows down, the watercraft will no longer respond to handlebar input until you apply throttle again or you reach trolling speed.

At trolling speed, the watercraft can be turned gradually by handlebar position alone using just the amount of thrust available at idle.

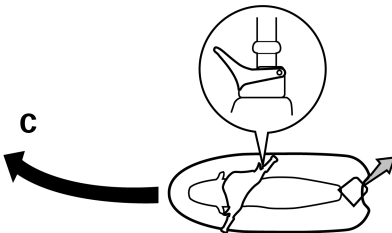

D. If the engine is stopped while riding, there is no thrust. The watercraft will go straight even though the handlebars are turned.

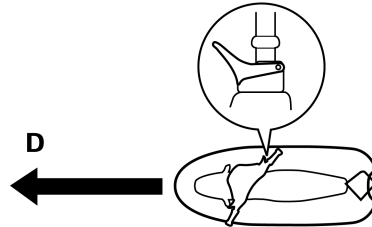

You need throttle to steer.

EWJ00770

WARNING

- **Do not release the throttle lever when trying to steer away from objects—you need throttle to steer. A collision could result in severe injury or death.**
- **When operating at higher speeds, make gradual turns or slow down before turning. Sharp high-speed turns may cause the watercraft to slide sideways or spin, throwing the operator and passengers overboard, which could cause an injury.**

This model is equipped with the Yamaha Engine Management System (YEMS) that includes an off-throttle steering (OTS) system. It will activate at planing speeds should you attempt to steer the watercraft after releasing the throttle lever (see condition C above).

The OTS system assists in turning by continuing to supply some thrust while the watercraft is decelerating, but you can turn more sharply if you apply throttle while turning the handlebars. The OTS system does not function below planing speeds or when the engine is off. Once the engine slows down, the watercraft will no longer turn in response to handlebar in-

put until you apply throttle again or you reach trolling speed.

EJU33280

Stopping the watercraft

The watercraft is not equipped with a separate braking system. It is stopped by water resistance when the throttle lever is released. From full speed, the watercraft comes to a complete stop in approximately 100 m (330 ft) after the throttle lever is released or the engine is stopped, although this distance will vary depending on many factors, including gross weight, water surface conditions, and wind direction.

The watercraft slows down as soon as the throttle lever is released, but will coast for a distance before fully stopping. If you are not sure you can stop in time before hitting an obstacle, apply throttle and turn in another direction.

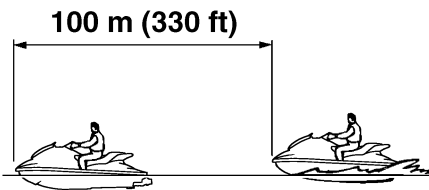

EWJ00730

WARNING

- Allow adequate stopping distance.
- Take early action to avoid collisions. Remember, watercraft and other boats do not have brakes.
- Operate defensively at safe speeds and keep a safe distance away from people, objects, and other watercraft to give you time to stop.
- Do not shut the engine off when slowing down in case you need engine power to

steer away from a boat or other obstacle that comes into your path.

- For VX Deluxe/VX Cruiser:

Do not use the reverse function to slow down or stop the watercraft as it could cause you to lose control, be ejected, or impact the handlebars.

EJU35960

Beaching the watercraft

- (1) Make sure that there are no boats, swimmers, or obstacles near the beach. Release the throttle lever about 100 m (330 ft) before you reach the intended beaching area.
- (2) Approach the beach slowly and stop the engine before reaching land. Remember, you need throttle to steer.
- (3) Get off the watercraft and pull it up on the beach.

EGJ00490

CAUTION:

Small pebbles, sand, seaweed, and other debris can be sucked into the jet intake and impair or damage the impeller. Always stop the engine and get off the watercraft before beaching it.

EJU36060

Docking the watercraft

- (1) Make sure that there are no boats, swimmers, or obstacles near the watercraft. Reduce speed about 100 m (330 ft) away from the dock.
- (2) Slowly approach the dock and stop the engine just before coming alongside it.

EJU33320

Reverse on waterways (for VX Deluxe/VX Cruiser)

Reverse can be used for slow-speed maneuvering when it is necessary to back up out of tight spots where you cannot turn around. Reverse can be used to slow down or stop only

Operation

during slow-speed maneuvering, such as when docking.

Once the engine is idling, shift into reverse and gradually increase engine speed. Make sure that there are no obstacles or people behind you before shifting into reverse.

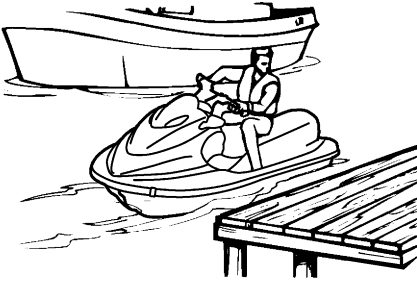

EJU33350

Rough water operation

The force of landing after jumping can cause a strong impact on both the watercraft and the operator and passengers. It is possible for the operator to hit his or her chest or jaw on the watercraft or handlebars and be injured. The passengers could also impact the watercraft and be injured.

Do not operate the watercraft with your chin right above the handlebars. In addition, the operator and passengers should keep their feet on the floor of the footwell.

Operating in rough water or jumping waves can also crack the watercraft hull and deck, and damage internal parts. Avoid operating in rough water or bad weather conditions.

EJU33381

Post-operation care

To keep your watercraft in top shape, always take it out of the water after using it and perform the following procedures. Leaving the watercraft in the water for extended periods will accelerate the rate of normal deterioration of the jet unit components and hull finish. Marine organisms and corrosion are some of the conditions that can adversely affect the life of many watercraft components.

- (1) Remove the watercraft from the water.
- (2) Wash down the hull, handlebars, and jet unit with fresh water.
- (3) Remove the seat and check the engine compartment for water. To drain excess water, remove the stern drain plugs, and then raise the bow of the watercraft enough to allow the water in the bilge to drain out.

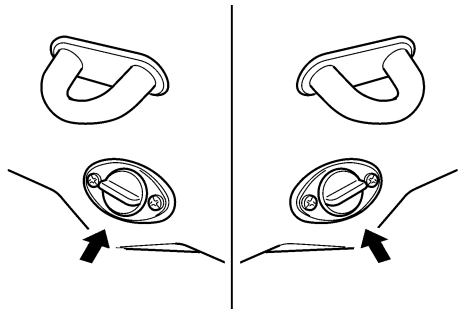

NOTE:

This watercraft is equipped with an automatic bilge draining system that removes water from the engine compartment while you are underway. However, some residual water will remain.

- (4) Place the watercraft in a horizontal position.
- (5) Flush the cooling system to prevent it from clogging with salt, sand, or dirt. (See page 63 for flushing procedures.)

- (6) Drain residual water from the exhaust system by alternately squeezing and releasing the throttle lever for 10 to 15 seconds while the engine is running.

ECJ00561

CAUTION:

Do not run the engine for more than 15 seconds without supplying water, otherwise the engine could overheat.

- (7) If the watercraft will be stored for a week or more, lubricate internal engine components to help prevent corrosion. (See page 64 for lubrication procedures.)
- (8) Rinse the engine and engine compartment with a small amount of water.

ECJ00570

CAUTION:

Do not use high-pressure water when rinsing the engine or engine compartment as severe engine damage could result.

- (9) Wipe the engine and engine compartment dry with a clean cloth (repeat step 3, if necessary).
- (10) Wipe the hull, handlebars, and jet unit dry with a clean cloth.
- (11) Spray a rust inhibitor on metallic parts to minimize corrosion.
- (12) Allow the engine compartment to air dry completely before installing the seat.

EJU33451

Transporting

When transporting the watercraft on a trailer, secure the tie downs to the trailer through the bow eye and stern eyes.

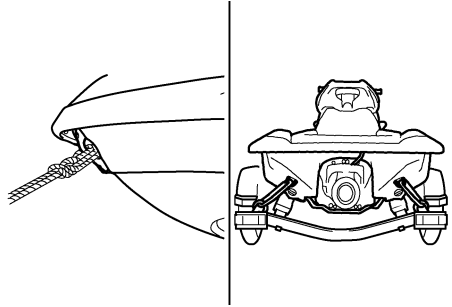

ECJ00621

CAUTION:

- Do not attach ropes or tie downs to any part of the watercraft other than the bow eye and stern eyes to secure the watercraft to the trailer. Otherwise, the watercraft may be damaged.
- Do not route ropes or tie downs over the seat, as they may leave permanent marks on the seat's surface. Also, wrap the ropes or tie downs with towels or rags where they touch the body of the watercraft to avoid scratches or damage.
- For VX Deluxe/VX Cruiser: Before putting the watercraft on the trailer or transporting it, be sure to put the shift lever in the forward position, otherwise the reverse gate may hit an obstacle, which may cause damage.

Maintenance and care

EJU33490

Storage

EWJ00330

WARNING

Always place the watercraft upright in a horizontal position when storing it, otherwise fuel could leak out into the engine or engine compartment, which could create a fire hazard.

Storage for long periods of time, such as winter storage, requires preventive maintenance to ensure against deterioration. It is advisable to have the watercraft serviced by a Yamaha dealer prior to storage. However, the following procedures can be performed by the owner.

EJU33542

Flushing the cooling system

Flushing the cooling system is essential to prevent it from clogging with salt, sand, or dirt.

ECJ00121

CAUTION:

- Do not supply water to the cooling water passages when the engine is not running. The water could flow back through the muffler into the crankcase, causing severe engine damage.
- Do not run the engine for more than 15 seconds without supplying water or over 4000 r/min on land, otherwise the engine could overheat.

- (1) Place the watercraft in a horizontal position.
- (2) Remove the seat. (See page 23 for seat removal and installation procedures.)
- (3) Remove the flushing hose connector cap, and then insert the garden hose

adapter into the flushing hose connector and turn it until it is securely connected.

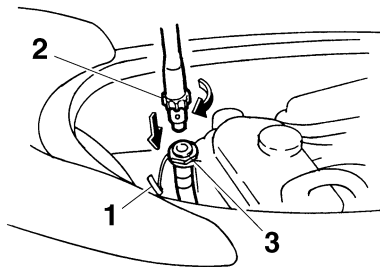

- 1 Flushing hose connector cap
- 2 Garden hose adapter
- 3 Flushing hose connector

- (4) Connect the garden hose adapter to a water tap using a garden hose.

NOTE:

A garden hose is not included and must be purchased separately.

- (5) Start the engine, and then immediately turn the water supply on until water flows out continually from the jet thrust nozzle.

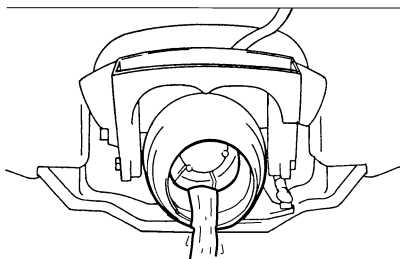

- (6) Run the engine at idling speed for about 3 minutes watching the engine condition. If the engine stops while flushing, turn the water supply off immediately and repeat the above steps.
- (7) Turn the water supply off, and then force the remaining water out of the cooling

Maintenance and care

water passages by alternately squeezing and releasing the throttle lever for 10 to 15 seconds.

- (8) Stop the engine.
- (9) Remove the garden hose adapter and install the flushing hose connector cap.

EJU33622

Lubrication

EWJ00260

WARNING

Do not spray flammable rust inhibitor products on engine surfaces while the engine is hot. The sprayed substance or propellants could catch fire.

- (1) Remove the seat. (See page 23 for seat removal and installation procedures.)
- (2) Loosen the clamp screw and disconnect the air intake duct.

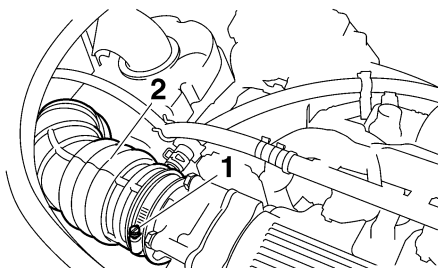

- 1 Clamp screw
- 2 Air intake duct

- (3) Spray a rust inhibitor into the intake opening for 3 seconds.

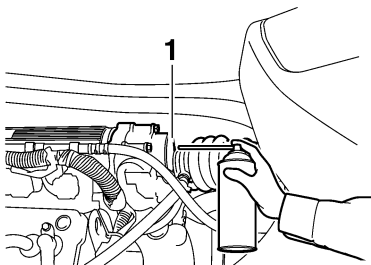

- 1 Intake opening

- (4) Connect the air intake duct and tighten the clamp screw.
- (5) Start the engine in a well-ventilated area and let it run at idle for 15 seconds.

ECJ00561

CAUTION:

Do not run the engine for more than 15 seconds without supplying water, otherwise the engine could overheat.

- (6) Lubricate all cables such as the throttle and steering cables.

NOTE:

Use a suitable marine grease applicator to pressure-lubricate the cables and purge out any moisture between the inner and outer cables.

- (7) Lubricate the areas of the watercraft specified in "Lubrication points" on page 73.

EJU33670

Fuel system

EWJ00280

WARNING

GASOLINE AND ITS VAPORS ARE HIGHLY FLAMMABLE AND EXPLOSIVE!

Maintenance and care

- Do not smoke when refueling, and keep away from sparks, flames, and other sources of ignition.
 - Stop the engine before refueling.
 - Refuel in a well-ventilated area with the watercraft in a horizontal position.
 - Do not stand or sit on the watercraft while refueling in case of fire.
 - Take care not to spill gasoline. If gasoline spills, wipe it up immediately with dry rags. Always properly dispose of gasoline-soaked rags.
 - Avoid overfilling the fuel tank. Stop filling when the fuel level reaches approximately 50 mm (2 in) from the top of the fuel tank. Fuel expands as it warms up and could overflow if the fuel tank has been overfilled. If temporarily leaving the watercraft with a full fuel tank, do not leave it in direct sunlight. Leave it in a well-ventilated area with the watercraft in a horizontal position.
 - Tighten the fuel tank filler cap securely after refueling.
 - If you should swallow some gasoline, inhale a lot of gasoline vapor, or get gasoline in your eyes, get immediate medical attention.
 - If any gasoline spills on your skin or clothing, immediately wash the affected area with soap and water and change your clothes.
- (1) Disconnect the negative (–) battery lead first, then the positive (+) battery lead and breather hose, and then remove the battery from the watercraft.
 - (2) Clean the battery casing using fresh water.
 - (3) If the battery terminals are dirty or corroded, clean them with a wire brush.
 - (4) Fully charge the battery.
 - (5) Apply Yamaha Marine Grease or Yamaha Grease A to the battery terminals, and then store the battery in a cool, dry place.
 - (6) Check the battery at least once every 2 months and fully charge it if necessary.

ECJ00100

CAUTION:

Always keep the battery charged. Storing a discharged battery can cause permanent battery damage.

To check the condition of the battery, check the specific gravity of the electrolyte or measure the voltage at both battery terminals. Charge the battery if the voltage is less than 12 volts.

Specific gravity (for reference): 1.28 at 20 °C (68 °F)
--

It is recommended to have a Yamaha dealer check the specific gravity and charge the battery. If you maintain the battery yourself, be sure to read and follow the instructions provided with the battery tester and charger you use.

EJU33730

Cleaning the watercraft

Clean the watercraft before storing it for a long period.

- (1) Wash down the hull, handlebars, and jet unit with fresh water.

Top off the fuel tank with fresh gasoline and add fuel stabilizer and conditioner to the fuel tank according to the manufacturer's instructions.

EJU33680

Battery

If the watercraft will not be used for more than a month, remove the battery from the watercraft and store it in a cool, dry place.

- (2) Rinse the engine and bilge area with fresh water. Drain all of the water and wipe up any remaining moisture with clean, dry rags.

ECJ00110

CAUTION:

Do not use high-pressure water when rinsing the engine and bilge area as severe engine damage could result.

- (3) Spray the engine's exterior with a rust inhibitor and lubricant.
- (4) Wax the hull with a non-abrasive wax.
- (5) Wipe all vinyl and rubber components, such as the seat and engine compartment seals, with a vinyl protectant.

EJU33761

Maintenance and adjustments

Periodic inspection, adjustment, and lubrication will keep your watercraft in the safest and most efficient condition possible. Safety is an obligation of the watercraft owner. Proper maintenance must be carried out to keep the exhaust emission and sound levels within the regulated limits. The most important points of watercraft inspection, adjustment, and lubrication are explained on the following pages. See a Yamaha dealer for genuine Yamaha replacement parts and optional accessories designed for your watercraft.

Remember, failures that are the result of the installation of parts or accessories which are not qualitatively equivalent to genuine Yamaha parts are not covered by the limited warranty.

Maintenance, replacement, or repair of the emission control devices and system may be performed by any marine SI engine repair establishment or individual. Warranty repair, however, must be performed at an authorized Yamaha marine dealership.

EWJ00310

! WARNING

- **Be sure to shut the engine off when you perform maintenance unless otherwise specified, otherwise an accident or injury could result from unexpected operation, moving parts, or electric shock. If the owner is not familiar with watercraft servicing, this work should be done by a Yamaha dealer. Improperly serviced components could fail or stop operating correctly, which could result in an accident.**
- **Modifications to this watercraft not approved by Yamaha may cause loss of performance or excessive noise and exhaust emissions, or render it unsafe for**

Maintenance and care

use. Consult a Yamaha dealer before attempting any modifications.

EJU33810

Owner's/operator's manual and tool kit

It is advisable to always carry the owner's/operator's manual and tool kit with you whenever you use the watercraft. For your convenience, a storage compartment is provided on the watercraft for the manual and tool kit.

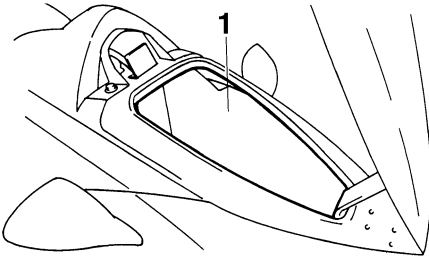

1 Storage compartment

NOTE:

To protect these materials from water damage, it would be a good idea to put them in a waterproof bag.

The service information included in this manual is intended to provide you, the owner, with the necessary information for completing your own preventive maintenance and minor repairs. The tools provided in the tool kit are sufficient for this purpose, except that a torque

wrench may also be necessary to tighten nuts and bolts.

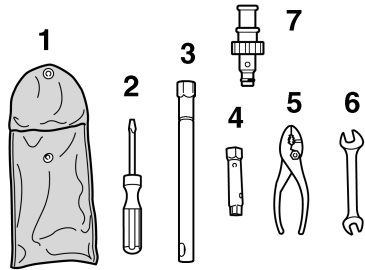

- 1 Tool bag
- 2 Screwdriver
- 3 16 mm box wrench
- 4 10/12 mm box wrench
- 5 Pliers
- 6 Open-end wrench
- 7 Garden hose adapter

Maintenance and care

EJU33821

Periodic maintenance chart

The following chart gives general guidelines for periodic maintenance. However, maintenance may need to be performed more frequently depending on your operating conditions.

This “●” mark indicates maintenance that you may do yourself.

This “○” mark indicates work to be done by a Yamaha dealer.

Item	Operation	Initial			Thereafter every		Page
		10 hours	50 hours	100 hours	100 hours	200 hours	
			6 months	12 months	12 months	24 months	
Spark plugs	Check, clean, adjust	●		●	●		72
Lubrication points	Lubricate			●/○	●/○		73
Fuel system	Check			○	○		70
Fuel tank	Check, clean			●/○	●/○		70
Trolling speed	Check, adjust			●/○	●/○		76
Throttle shaft	Check			○	○		—
Cooling water passages	Flush	●*					63
Water inlet strainer	Check, clean			○	○		—
Bilge strainer	Clean			○	○		—
Impeller	Check			○	○		—
Jet thrust nozzle angle	Check, adjust			●/○	●/○		71
Shift cable and reverse gate (VX Deluxe/VX Cruiser)	Check, adjust			●/○	●/○		71
Throttle cable	Check, adjust	○		●	●		72
Stern drain plugs	Check, replace			○	○		44
Battery	Check, charge			●/○	●/○		74
Rubber coupling	Check					○	—
Engine mount	Check					○	—
Nuts and bolts	Check	○		○	○		—
Air filter element	Check			○	○		71
Engine oil	Replace	○		○	○		70

Maintenance and care

Item	Operation	Initial			Thereafter every		Page
		10 hours	50 hours	100 hours	100 hours	200 hours	
			6 months	12 months	12 months	24 months	
Oil filter	Replace			○	○		70
Valve clearance	Check, adjust					○	—

* This operation should be performed after every use.

EJU34210

Checking the fuel system

EWJ00380

WARNING

Gasoline is highly flammable and explosive. Failure to check for and repair any fuel leakage could result in a fire or explosion. A fire or explosion can cause severe injury or death. Shut the engine off. Do not smoke. Avoid spilling gasoline.

Fuel in the fuel lines is pressurized.

Fuel can spray out and cause injury or a fire hazard if a fuel line is disconnected.

Do not run the engine with a fuel line disconnected.

Check the fuel system for leaks, cracks, and malfunctions. If any problem is found, consult a Yamaha dealer.

Check:

- Fuel tank filler cap and seal for damage.
- Fuel in fuel tank for water and dirt.
- Fuel tank for damage, cracks, and leakage.
- Fuel hoses and joints for damage, cracks, and leakage.
- Air bleeding passages for leakage.

EJU34230

Fuel tank

Check the fuel tank for leakage and for water in the tank. If water is found in the fuel system, or if the fuel tank needs to be cleaned, have a Yamaha dealer service the watercraft.

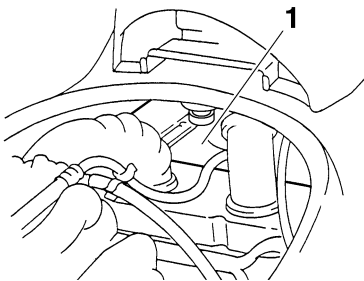

1 Fuel tank

EJU34291

Engine oil and oil filter

EWJ00340

WARNING

Engine oil is extremely hot immediately after the engine is turned off. Coming in contact with or getting any engine oil on your clothes could result in burns.

ECJ00180

CAUTION:

- Do not run the engine with too much or not enough oil in the oil tank. Oil could spray out and the engine could be damaged.
- Be sure to change the engine oil after the first 10 hours of operation, and every 100 hours thereafter or at the start of a new season, otherwise the engine will wear quickly.

The oil filter should be replaced every year or every 100 hours of operation. Have a Yamaha dealer replace the oil filter if necessary.

It is recommended to have a Yamaha dealer change the engine oil. However, if you choose to change the oil on your own, consult a Yamaha dealer.

NOTE:

Dispose of used oil according to local regulations.

Recommended engine oil:

SAE 10W-30, 20W-40, 20W-50

Oil grade:

API SE, SF, SG, SH, SJ, SL

Oil quantity:

With oil filter replacement:

2.2 L (2.33 US qt) (1.94 Imp.qt)

Without oil filter replacement:

2.0 L (2.11 US qt) (1.76 Imp.qt)

Total amount:

4.3 L (4.55 US qt) (3.78 Imp.qt)

Maintenance and care

ECJ00190

CAUTION:

If oil is leaking or the oil pressure warning indicator comes on when the engine is running, immediately shut the engine off and have a Yamaha dealer check the watercraft. Continuing to operate the engine under such conditions could cause severe engine damage.

EJU34310

Air filter element

Have a Yamaha dealer check and clean or replace the air filter element every 12 months or every 100 hours of operation.

EJU34321

Checking the jet thrust nozzle angle

Check the handlebars and jet thrust nozzle for smooth operation.

Turn the handlebars as far as possible to the right and left and check that the difference of distances A and B between the jet thrust nozzle and the nozzle is within specification.

Difference of A and B:
Maximum 5 mm (0.20 in)

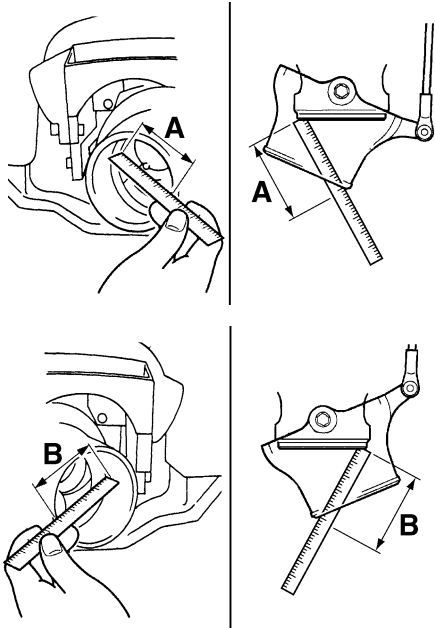

If the steering is stiff or misadjusted, have a Yamaha dealer service it.

EJU34350

Checking the shift cable (for VX Deluxe/VX Cruiser)

Place the shift lever in the reverse position. Make sure that the reverse gate makes contact with the stopper.

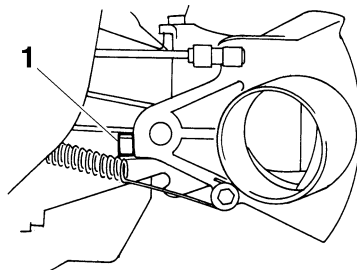

1 Stopper

Maintenance and care

If the reverse gate does not make contact with the stopper, have a Yamaha dealer service it.

EJU36640

Checking and adjusting the throttle cable

Check that the throttle cable moves back to the set position smoothly and that the throttle lever free play is within specification.

Squeeze and release the throttle lever. If the throttle lever does not return smoothly, have a Yamaha dealer service it.

If the specified throttle lever free play cannot be obtained as described below, have a Yamaha dealer make the adjustment.

- (1) Remove the six screws, and then remove the front handlebar cover.

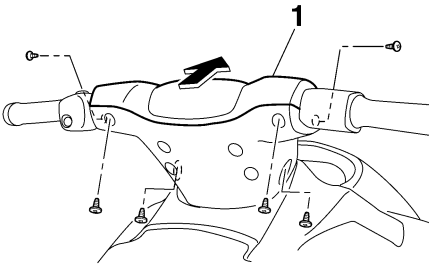

1 Front handlebar cover

- (2) Slide the rubber cover away from the adjuster, and then loosen the locknut.

- (3) Adjust the free play by turning the adjuster.

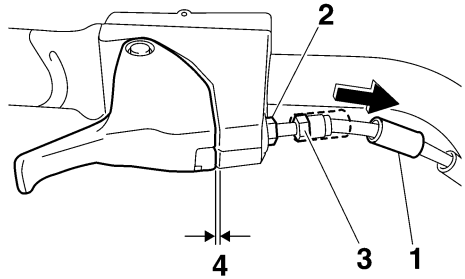

- 1 Rubber cover
- 2 Locknut
- 3 Adjuster
- 4 Throttle lever free play

Throttle lever free play:
4.0–7.0 mm (0.16–0.28 in)

- (4) Hold the adjuster with one wrench while tightening the locknut with another wrench. Slide the rubber cover to its original position.
- (5) Install the front handlebar cover, and then install the six screws.

EJU34391

Cleaning and adjusting the spark plugs

The spark plug is an important engine component and is easy to inspect. The condition of the spark plug can indicate something about the condition of the engine. For example, if one spark plug has a distinctly different color, the engine could require servicing. Do not attempt to diagnose any problems yourself. Have a Yamaha dealer service the watercraft. Remove and inspect the spark plugs periodically; heat and deposits will cause the spark plugs to slowly break down and erode. If electrode erosion becomes excessive, or if carbon and other deposits are excessive, replace the spark plug with the specified plug.

Maintenance and care

Specified spark plug:
CR9EB

To remove a spark plug:

- (1) Remove the seat. (See page 23 for seat removal and installation procedures.)
- (2) Remove the spark plug cap.

ECJ00210

CAUTION:

Do not use any tools to remove or install the spark plug cap, otherwise the ignition coil coupler could be damaged. The spark plug cap may be difficult to remove because the rubber seal on the end of the cap fits tightly. To remove the spark plug cap, simply twist it back and forth while pulling it up; to install it, twist it back and forth while pushing it down.

- (3) Remove the spark plug.
Measure the spark plug gap with a wire thickness gauge. Replace the spark plug or adjust the gap to specification if necessary.

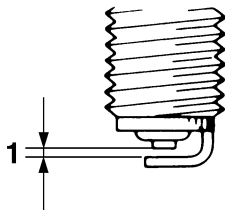

1 Spark plug gap

Spark plug gap:
0.7–0.8 mm (0.028–0.031 in)

To install a spark plug:

- (1) Clean the gasket surface.
- (2) Wipe any dirt from the threads of the spark plug.

- (3) Install the spark plug, and then tighten it to the specified torque.

Spark plug tightening torque:
12.5 Nm (9.2 ft-lb) (1.27 kgf-m)

- (4) Install the spark plug cap.

NOTE:

- Wipe off any water on the spark plug or inside the spark plug cap before installing the cap. Push the spark plug cap down until it is securely installed.
- If a torque wrench is not available when you are installing a spark plug, a good estimate of the correct torque is 1/4 turn to 1/2 turn past finger tight using the spark plug wrench included in the tool kit. Have the spark plug adjusted to the correct torque with a torque wrench as soon as possible.

EWJ00350

WARNING

Be careful not to damage the insulator when removing or installing a spark plug. A damaged insulator could allow sparks to escape, which could result in a fire or explosion.

- (5) Install the seat.

EJU34422

Lubrication points

To keep moving parts sliding or rotating smoothly, coat them with water-resistant grease.

Recommended water-resistant grease:
Yamaha Marine Grease/Yamaha Grease A

- Throttle cable (handlebar end)
Loosen the adjuster and disconnect the outer cable from the bracket. Spray a rust inhibitor into the outer cable. Connect the outer cable, and then adjust the throttle ca-

Maintenance and care

ble free play. (See page 72 for adjustment procedures.)

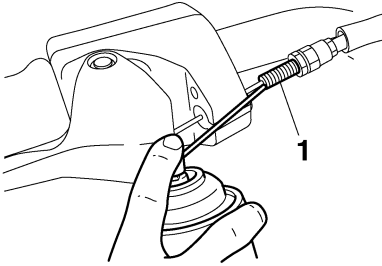

1 Adjuster

- Steering cable (handlebar end)

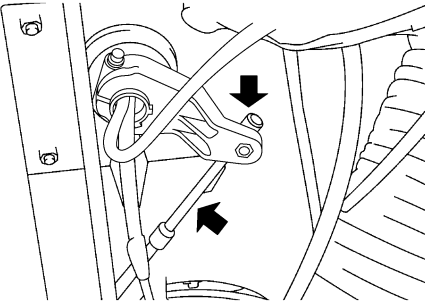

- Steering cable (jet thrust nozzle end)

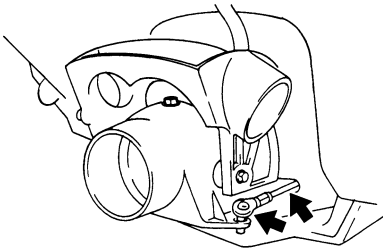

- For VX Deluxe/VX Cruiser:
Shift cable (reverse gate end)

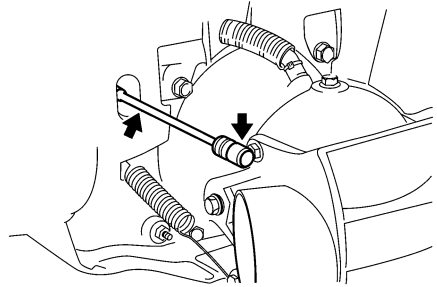

EJU34451

Checking the battery

Check the level of the battery electrolyte and make sure that the negative (-) and positive (+) battery leads are tightened securely.

EWJ00790

! WARNING

Battery electrolyte is poisonous and dangerous, causing severe burns, etc. Electrolyte contains sulfuric acid. Avoid contact with skin, eyes, or clothing.

Antidotes

External: Flush with water.

Internal: Drink large quantities of water or milk. Follow with milk of magnesia, beaten egg, or vegetable oil. Call a physician immediately.

Eyes: Flush with water for 15 minutes and get prompt medical attention.

Batteries produce explosive gases. Keep sparks, flames, cigarettes, etc., well away. If using or charging the battery in an enclosed space, make sure that it is well ventilated. Always shield your eyes when working near batteries.

KEEP OUT OF THE REACH OF CHILDREN.

Maintenance and care

ECJ00230

CAUTION:

- Be careful not to place the battery on its side.
- Be sure to remove the battery from the battery compartment when adding electrolyte or charging the battery.

To remove the battery:

Disconnect the negative (-) battery lead first, then the positive (+) battery lead and breather hose, and then remove the battery from the watercraft.

To replenish the battery:

- (1) Make sure that the electrolyte level is between the maximum and minimum level marks.

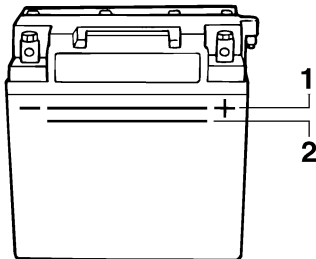

- 1 Maximum level mark
- 2 Minimum level mark

- (2) If the electrolyte level is low, add distilled water to raise it to the specified level.

ECJ00240

CAUTION:

Normal tap water contains minerals that are harmful to a battery. Use only distilled water for replenishing the battery.

To recharge the battery:

ECJ00250

CAUTION:

Do not attempt to charge a battery hastily. Battery life could be shortened.

It is recommended to have a Yamaha dealer charge the battery. If you charge the battery yourself, be sure to read and follow the instructions provided with the battery tester and charger you use.

To install the battery:

- (1) Place the battery in the battery compartment and connect the battery leads to the battery terminals.
- (2) Connect the breather hose to the battery.
- (3) Secure the battery in place.

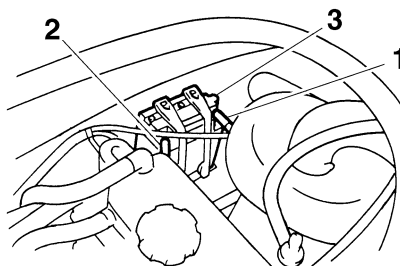

- 1 Positive (+) battery terminal: Red lead
- 2 Negative (-) battery terminal: Black lead
- 3 Breather hose

EWJ00400

WARNING

Be sure to connect the breather hose to the battery. Fire or explosion could result if the breather hose is damaged, obstructed, or not connected properly.

ECJ00260

CAUTION:

After installation, make sure that the battery leads are properly connected to the battery terminals.

EJU34490

Fuel injection system

The fuel injection system was set at the Yamaha factory. If the fuel injection system needs to be adjusted, have a Yamaha dealer service the watercraft.

ECJ00220

CAUTION:

Do not attempt to adjust the fuel injection system. If the settings are disturbed by someone who does not have the necessary technical knowledge, poor engine performance and damage may result.

EJU34500

Checking the trolling speed

- (1) Place the watercraft in the water.
- (2) Start the engine and warm it up. Use the tachometer in the multifunction information center to check the trolling speed.

Trolling speed: 1650 \pm 50 r/min
--

If the trolling speed is out of specification, have a Yamaha dealer service the watercraft.

Specifications

EJU34542

Specifications

Watercraft capacity:

Maximum people on board:

3 person

Maximum load capacity:

240 kg (530 lb)

Dimensions:

Length:

3220 mm (126.8 in)

Width:

1170 mm (46.1 in)

Height:

1150 mm (45.3 in)

Dry weight:

VX 319 kg (703 lb)

VX Deluxe 322 kg (710 lb)

VX Cruiser 323 kg (712 lb)

Performance:

Maximum output (according to ISO 8665/SAE

J1228):

75.00 kW@8000 r/min

Maximum fuel consumption:

28.0 L/h (7.4 US gal/h) (6.2 Imp.gal/h)

Cruising range at full throttle:

2.14 hour

Trolling speed:

1650 ±50 r/min

Engine:

Engine type:

Liquid cooled 4-stroke, DOHC

Number of cylinders:

4

Engine displacement:

1052 cm³

Bore & stroke:

76.0 × 58.0 mm (2.99 × 2.28 in)

Compression ratio:

11.4 : 1

Valve clearance-intake (cold):

0.11–0.20 mm (0.0043–0.0079 in)

Valve clearance-exhaust (cold):

0.25–0.34 mm (0.0098–0.0134 in)

Lubrication system:

Dry sump

Cooling system:

Water

Starting system:

Electric

Ignition system:

T.C.I.

Spark plug:

CR9EB

Spark plug gap:

0.7–0.8 mm (0.028–0.031 in)

Battery capacity:

12 V, 19.0 Ah

Charging system:

Flywheel magneto

Drive unit:

Propulsion system:

Jet pump

Jet pump type:

Axial flow, single stage

Impeller rotation:

Counterclockwise

Jet thrust nozzle angle:

24.0+24.0 °

Fuel and oil:

Recommended fuel:

Regular unleaded gasoline

Minimum octane rating (PON):

86

Minimum octane rating (RON):

90

Recommended engine oil type SAE:

SAE 10W-30, 20W-40, 20W-50

Recommended engine oil grade API:

API SE,SF,SG,SH,SJ,SL

Fuel tank total capacity:

60 L (15.9 US gal) (13.2 Imp.gal)

Engine oil quantity with oil filter replacement:

2.2 L (2.33 US qt) (1.94 Imp.qt)

Engine oil quantity without oil filter replacement:

2.0 L (2.11 US qt) (1.76 Imp.qt)

Engine oil total quantity:

4.3 L (4.55 US qt) (3.78 Imp.qt)

Trouble recovery

EJU34560

Troubleshooting

If you have any trouble with your watercraft, use this section to check for the possible cause. If you cannot find the cause, or if the procedure for replacement or repair is not described in this owner's/operator's manual, have a Yamaha dealer perform the necessary service.

EJU34592

Troubleshooting chart

TROUBLE	POSSIBLE CAUSE		REMEDY	PAGE
Engine does not start (Starter motor does not turn over)	Yamaha Security System (VX Deluxe/VX Cruiser)	Lock mode selected	Select unlock mode	29
	Engine shut-off switch	Clip not in place	Install clip	25
	Fuse	Burned out	Replace the fuse and check wiring	82
	Battery	Run down	Recharge	74
		Poor terminal connections	Tighten as required	74
		Terminal corroded	Clean	65
	Starter motor	Faulty	Have serviced by Yamaha dealer	—
Engine does not start (Starter motor turns over)	Throttle lever	Squeezed	Release	26
	Fuel	Empty	Refill as soon as possible	39
		Stale or contaminated	Have serviced by Yamaha dealer	70
	Fuel tank	Water or dirt present	Have serviced by Yamaha dealer	70
	Spark plug	Fouled or defective	Clean or replace	72
	Spark plug cap	Not connected or loose	Connect properly	72
		Connected to wrong cylinder	Connect properly	72
Fuel injection system	Fuel pump faulty	Have serviced by Yamaha dealer	—	

Trouble recovery

TROUBLE	POSSIBLE CAUSE		REMEDY	PAGE
Engine runs irregularly or stalls	Fuel	Empty	Refill as soon as possible	39
		Stale or contaminated	Have serviced by Yamaha dealer	70
	Fuel tank	Water or dirt present	Have serviced by Yamaha dealer	70
	Spark plug	Fouled or defective	Replace	72
		Incorrect heat range	Replace	72
		Gap incorrect	Adjust	72
	Spark plug cap	Loose	Connect properly	72
		Cracked, torn, or damaged	Have serviced by Yamaha dealer	—
	Electrical wiring	Loose connection	Have serviced by Yamaha dealer	—
Fuel injection system	Faulty or clogged injectors	Have serviced by Yamaha dealer	—	
Warning light or indicator blinks	Fuel level	Empty	Refill as soon as possible	39
	Engine overheated	Jet intake clogged	Clean	80
	Check engine warning	Faulty sensors	Have serviced by Yamaha dealer	34
Watercraft slow or loses power	Yamaha Security System (VX Deluxe/VX Cruiser)	Low-RPM mode selected	Select normal mode	30
	Cavitation	Jet intake clogged	Clean	80
		Impeller damaged or worn	Have serviced by Yamaha dealer	80
	Engine overheat warning	Engine speed reduction control activated	Clean jet intake and cool engine	33
	Oil pressure warning	Engine speed reduction control activated	Add oil	32
	Spark plug	Fouled or defective	Replace	72
		Incorrect heat range	Replace	72
		Gap incorrect	Adjust	72
	Spark plug caps	Loose	Connect properly	72
	Electrical wiring	Loose connection	Have serviced by Yamaha dealer	—
	Fuel	Stale or contaminated	Have serviced by Yamaha dealer	70
	Air filter	Clogged or oil buildup	Have serviced by Yamaha dealer	71

Trouble recovery

EJU34620

Emergency procedures

EJU34630

Cleaning the jet intake and impeller

If weeds or debris get caught in the jet intake or impeller, cavitation can occur, causing jet thrust to decrease even though engine speed rises. If this condition is allowed to continue, the engine will overheat and may seize. If there is any sign that the jet intake or impeller is clogged with weeds or debris, return to shore and check the intake and impeller. Always stop the engine before beaching the watercraft.

EWJ00780

WARNING

Before attempting to remove weeds or debris from the jet intake or impeller area, shut the engine off and remove the clip from the engine shut-off switch. Severe injury or death could result from coming in

contact with the rotating parts of the jet pump.

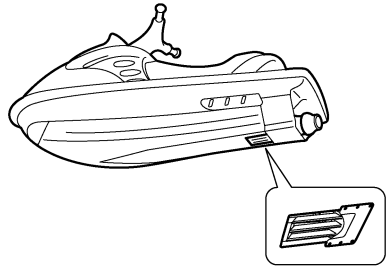
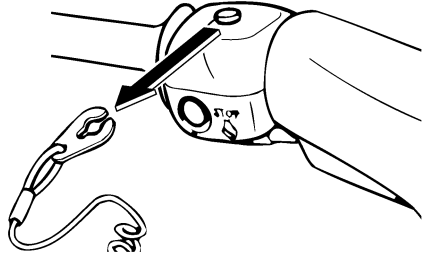

ECJ00650

CAUTION:

If weeds or debris get caught in the jet intake, do not operate the watercraft above trolling speed until they have been removed.

(1) Turn the watercraft on its side as shown.

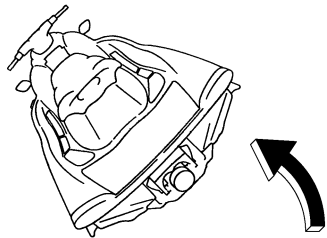

Trouble recovery

ECJ00660

CAUTION:

- Place a suitable clean cloth or carpeting underneath the watercraft to protect it from abrasions and scratches.
- Always turn the watercraft over onto its port (left) side.
- When turning the watercraft on its side, support the bow so that the handlebars are not bent or damaged.

(2) Remove any weeds or debris from around the drive shaft, impeller, jet pump housing, and jet thrust nozzle.

If debris is difficult to remove, consult a Yamaha dealer.

ECJ00670

CAUTION:

Always avoid operating your watercraft in areas where weed growth is thick. If traveling in weeded areas is unavoidable, operate the engine alternately at partial throttle and full throttle. Weeds tend to accumulate more at a steady speed and at trolling speed. If weeds clog the jet intake or impeller area and cause cavitation, follow the cleaning procedure above.

EJU34640

Jumping the battery

If the watercraft battery has run down, the engine can be started using a 12-volt booster battery and jumper cables.

EWJ00790

WARNING

Battery electrolyte is poisonous and dangerous, causing severe burns, etc. Electrolyte contains sulfuric acid. Avoid contact with skin, eyes, or clothing.

Antidotes

External: Flush with water.

Internal: Drink large quantities of water or milk. Follow with milk of magnesia, beaten

egg, or vegetable oil. Call a physician immediately.

Eyes: Flush with water for 15 minutes and get prompt medical attention.

Batteries produce explosive gases. Keep sparks, flames, cigarettes, etc., well away. If using or charging the battery in an enclosed space, make sure that it is well ventilated. Always shield your eyes when working near batteries.

KEEP OUT OF THE REACH OF CHILDREN.

EJU34661

Connecting the jumper cables

- (1) Connect the positive (+) jumper cable to the positive (+) battery terminals of both batteries.
- (2) Connect one end of the negative (-) jumper cable to the negative (-) battery terminal of the booster battery.
- (3) Connect the other end of the negative (-) jumper cable to an engine hanger.

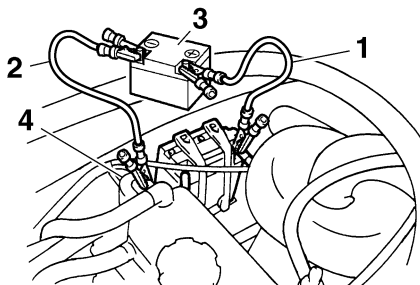

- 1 Positive (+) jumper cable
- 2 Negative (-) jumper cable
- 3 Booster battery
- 4 Engine hanger

ECJ00680

CAUTION:

Do not connect the end of the negative (-) jumper cable to the negative (-) battery terminal of the watercraft battery! Make sure that all connections are secure and correct before attempting to start the en-

Trouble recovery

gine. Any wrong connection could damage the electrical system.

- (4) Start the engine, and then disconnect the jumper cables by reversing the steps above.

ECJ00480

CAUTION:

- Never push the start switch while the engine is running.
- Do not operate the start switch for more than 5 seconds, otherwise the battery will be discharged and the engine will not start. Also, the starter motor could be damaged. If the engine does not start in 5 seconds, release the start switch, wait 15 seconds, and then try again.

EJU34690

Replacing the fuses

The fuses are located in the electrical box.

To replace a fuse:

- (1) Remove the cap on the electrical box.

- (2) Replace the blown fuse with the spare fuse of the correct amperage by using the fuse puller on the reverse side of the cap.

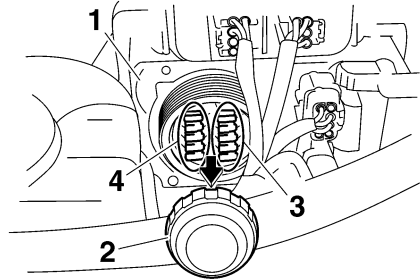

- 1 Electrical box
2 Cap
3 Fuse
4 Spare fuse

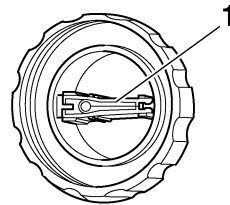

- 1 Fuse puller

Fuse amperage:

Battery fuse:

30 A

Main relay drive fuse:

10 A

Electronic throttle valve fuse:

10 A

Security system fuse:

3 A

Main fuse:

20 A

Trouble recovery

EWJ00800

WARNING

Do not use fuses of higher amperage than recommended. Substitution with a fuse that has an improper rating can cause extensive electrical system damage and possible fire.

EJU34710

Towing the watercraft

If the watercraft becomes inoperative in the water, it can be towed to shore.

If the watercraft must be towed in an emergency using a towline, the operator should ride the watercraft, holding onto the handlebars.

ECJ00720

CAUTION:

- **Tow the watercraft at 5 mph (8 km/h) or less, otherwise water could enter the engine through the exhaust passages or through the air intake and flood the engine compartment if it is towed too fast.**
- **Tow the watercraft using the bow eye only.**
- **The bow must be kept up out of the water during towing to prevent water from entering the engine compartment.**

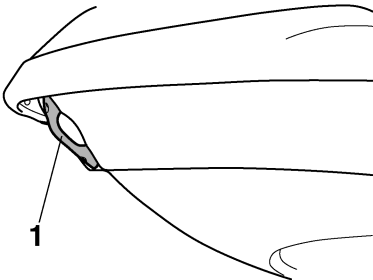

1 Bow eye

EWJ00810

WARNING

- **The watercraft should only be towed in an emergency.**
- **The towline should be long enough so that the watercraft will not collide with the towing boat when slowing down. A good rule of thumb is a towline that is three times the combined length of the towing boat and the watercraft.**
- **The operator of the towing boat must keep speed to a minimum and avoid traffic or obstacles which could be a hazard to the rider on the watercraft.**

EJU36150

Submerged watercraft

If the watercraft is submerged or flooded with water, follow the procedure below and consult a Yamaha dealer as soon as possible. Failure to do so could result in serious engine damage!

In an emergency:

- (1) Beach the watercraft and remove the stern drain plugs to drain the water from the engine compartment. (See page 43 for more information.) Remove the storage compartment drain plugs to drain the water from the storage compartments.
- (2) Install the stern drain plugs and storage compartment drain plugs.
- (3) Disconnect the spark plug caps, and then remove the spark plugs.

ECJ00760

CAUTION:

Do not connect the spark plugs to the spark plug caps.

- (4) Disconnect the fuel injector couplers.

ECJ00770

CAUTION:

Cover the disconnected fuel injector couplers so that they do not get wet. If the cou-

plers get wet, they could corrode, which could lead to poor connections.

- (5) Crank the engine for 5 seconds at wide open throttle. Repeat this step until all of the water in the cylinders has been expelled.
- (6) Spray a rust inhibitor into each spark plug hole for 5 seconds.
- (7) Crank the engine for 5 seconds at wide open throttle. Repeat this step several times.
- (8) Install the spark plugs, and then connect the spark plug caps and fuel injector couplers.

ECJ00780

CAUTION:

Do not start the engine even after completing the previous steps. Any water remaining in the engine could cause serious engine damage.

- (9) Have the watercraft inspected by a Yamaha dealer as soon as possible.

ECJ00790

CAUTION:

Be sure to have a Yamaha dealer inspect the watercraft. Otherwise, serious engine damage could result.

Index

A		
Air filter element	71	
B		
Battery	44, 65	
Battery, checking	74	
Battery, jumping	81	
Beaching the watercraft	60	
Bilge	43	
Boarding alone	55	
Boarding and starting from a dock	54	
Boarding and starting in deep water	54	
Boarding and starting in shallow water	54	
Boarding with passengers	55	
Bow eye	28	
Builder's plate	2	
C		
Capsized watercraft	57	
Check engine warning indicator	34	
Cleaning the watercraft	65	
Cooling water pilot outlet	26, 48	
Craft Identification Number (CIN)	1	
Cruising limitations	10	
D		
Docking the watercraft	60	
E		
Emergency procedures	80	
Engine break-in	49	
Engine compartment	42	
Engine oil	39	
Engine oil and oil filter	70	
Engine oil level	42	
Engine overheat warning indicator	33	
Engine serial number	1	
Engine shut-off cord	47	
Engine shut-off switch	25	
Engine stop switch	25	
Enjoy your watercraft responsibly	18	
F		
Fire extinguisher	45	
Flushing the cooling system	63	
Front storage compartment	35	
Fuel and oil	38	
Fuel injection system	75	
Fuel level	42	
Fuel level meter	31	
Fuel level warning indicator	32	
Fuel system	64	
Fuel system, checking	70	
Fuel tank	70	
Fuel tank filler cap	24	
Fuel tank, filling	39	
Fuses, replacing	82	
G		
Gasohol	38	
Gasoline	38	
Getting to know your watercraft	52	
Glove compartment	36	
H		
Handgrip	28	
Hazard information	14	
Hood	23	
Hour meter/voltmeter	32	
Hull and deck	42	
I		
Identification numbers	1	
Important labels	3	
J		
Jet intake	47	
Jet intake and impeller, cleaning	80	
Jet thrust nozzle angle, checking	71	
Jumper cables, connecting	81	
L		
Labels, other	7	
Labels, warning	4	
Launching the watercraft	49	
Learning to operate your watercraft	52	
Leaving the watercraft	51	
Limitations on who may operate the watercraft	9	
"L-MODE" indicator light (for VX Deluxe/ VX Cruiser)	35	
Lubrication	64	
Lubrication points	73	
M		
Main components, location of	19	
Maintenance and adjustments	66	
Model information	2	
Multifunction information center	30, 48	
O		
Oil pressure warning indicator	32	

Operating your watercraft.....	52	Submerged watercraft.....	83
Operation	49	Switches	48
Operation of controls and other functions	23	T	
Operation requirements	11	Tachometer	31
Owner's/operator's manual and tool kit....	67	Throttle cable, checking and adjusting.....	72
P		Throttle lever	26, 45
Periodic maintenance chart.....	68	Towing the watercraft.....	83
Post-operation care.....	61	Transporting	62
Pre-operation check list.....	40	Trolling speed, checking	76
Pre-operation check points	42	Troubleshooting	78
Pre-operation checks	40	Troubleshooting chart	78
Primary Identification (PRI-ID) number	1	Turning the watercraft	58
R		W	
Recommended equipment.....	13	Water separator	43
Remote control transmitter (for VX Deluxe/VX Cruiser).....	24	Watercraft characteristics.....	14
Reverse on waterways (for VX Deluxe/VX Cruiser).....	60	Water-skiing	16
Riding with passengers.....	53	Y	
Rough water operation.....	61	Yamaha Engine Management System (YEMS)	28
S		Yamaha Security System and low-RPM mode (for VX Deluxe/VX Cruiser).....	29
Safe boating rules	17	Yamaha Security System (for VX Deluxe/VX Cruiser).....	29
Seat.....	23	Yamaha Security System lock and unlock modes (for VX Deluxe/ VX Cruiser)	29
“SECURITY” indicator light (for VX Deluxe/VX Cruiser).....	34		
Selecting the normal mode/low-RPM mode (for VX Deluxe/VX Cruiser).....	30		
Shift cable, checking (for VX Deluxe/ VX Cruiser)	71		
Shift lever and reverse gate (for VX Deluxe/VX Cruiser).....	46		
Shift lever (for VX Deluxe/VX Cruiser)	27		
Spark plugs, cleaning and adjusting	72		
Speedometer.....	31		
Start switch.....	26		
Starting the engine	49		
Starting the watercraft	53		
Steering system	27, 45		
Stern drain plugs	44		
Stern eyes	28		
Stopping the engine	51		
Stopping the watercraft	60		
Storage.....	63		
Storage compartments.....	35		



Printed in USA
August 2007-0.7 x 1 CR