



**2005
WaveRunner
VX110 Sport
VX110 Deluxe**

**OWNER'S/OPERATOR'S
MANUAL**

**READ THIS MANUAL
CAREFULLY BEFORE OPERATION!**

YAMAHA MOTOR CO., LTD.
F1K-F8199-70

EC declaration of conformity

E

THE MANUFACTURER:

Yamaha Motor Europe N.V.

P.O.Box 75033; 1117 ZN Schiphol; The Netherlands

HEREBY DECLARES THAT THE

**Yamaha Personal Watercraft,
type and serial number :
VX110 Sport/VX110 Deluxe (F1K800501-)**

COMPLIES WITH THE PROVISIONS OF THE

Directive 89/336/EEC relating to electromagnetic compatibility (EMC),

COMPLIES WITH THE PROVISIONS OF THE FOLLOWING
HARMONIZED STANDARD:

- EN 50082-2

ALSO COMPLIES WITH THE FOLLOWING EUROPEAN STANDARDS,
NATIONAL STANDARDS AND TECHNICAL PROVISIONS:

- CISPR 12.

Done at Schiphol, (The Netherlands),

On, 2004-10-19



M. Inumaru,

President

Yamaha Motor Europe N.V.

EC declaration of conformity

Hereby, **Mitsubishi Electric Corporation Himeji Works**,
declares that this Remocon-Key System (Model: SKEA6S-01)
is in compliance with the essential requirements and other
relevant provisions of Directive 1999/5/EC.



TYPE SKEA6S-01
MITSUBISHI ELECTRIC
CORP. JAPAN

To the owner/operator

Thank you for choosing a Yamaha watercraft.

This Owner's/Operator's Manual contains information you will need for proper operation, maintenance, and care. A thorough understanding of these simple instructions will help you to obtain maximum enjoyment from your new Yamaha. If you have any questions about the operation or maintenance of your watercraft, please consult a Yamaha dealer.

Because Yamaha has a policy of continuing product improvement, this product may not be exactly as described in this Owner's/Operator's Manual. Specifications are subject to change without notice.

This manual should be considered a permanent part of this watercraft and should remain with it even if the watercraft is subsequently sold.

EJU12040

Important manual information:

In this manual, information of particular importance is distinguished in the following ways:



The Safety Alert Symbol means **ATTENTION! BECOME ALERT! YOUR SAFETY IS INVOLVED!**

!WARNING

Failure to follow WARNING instructions could result in severe injury or death to the machine operator, passengers, a bystander, or a person inspecting or repairing the watercraft.

CAUTION:

A CAUTION indicates special precautions that must be taken to avoid damage to the watercraft.

NOTE:

A NOTE provides key information to make procedures easier or clearer.

EJU09910

**WaveRunner VX110 Sport/VX110 Deluxe
OWNER'S/OPERATOR'S MANUAL
©2004 by Yamaha Motor Co., Ltd.
1st Edition, October 2004
All rights reserved.
Any reprinting or unauthorized use
without the written permission of
Yamaha Motor Co., Ltd.
is expressly prohibited.
Printed in USA**

CONTENTS



GENERAL AND SAFETY INFORMATION

1



FEATURES AND FUNCTIONS

2



OPERATION

3



MAINTENANCE AND CARE

4



TROUBLESHOOTING AND EMERGENCY PROCEDURES

5



APPENDIX

6

**READ THIS OWNER'S/OPERATOR'S MANUAL CAREFULLY
BEFORE OPERATING YOUR WATERCRAFT.**

GENERAL AND SAFETY INFORMATION



Identification numbers	1-1
Primary Identification (PRI-ID) number	1-1
Hull Identification Number (HIN)	1-2
Engine serial number	1-2
Emission control information (For Canada only)	1-3
Approval label of emission control certificate	1-3
Manufactured date label	1-3
Important labels	1-4
Label location	1-4
Warning labels	1-5
Other labels	1-9
Safety information	1-11
Limitations on who may operate the watercraft	1-11
Cruising limitations	1-12
Operation requirements	1-13
Recommended equipment	1-15
Hazard information	1-16
Watercraft characteristics	1-16
Water-skiing	1-18
Safe boating rules	1-20
Enjoy your watercraft responsibly	1-20



EJU18300

Identification numbers

Record the Primary Identification (PRI-ID) number, Hull Identification Number (HIN) and engine serial number in the spaces provided for assistance when ordering spare parts from a Yamaha dealer. Also record and keep these ID numbers in a separate place in case your watercraft is stolen.

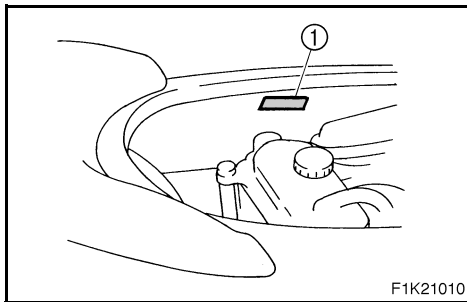

EJU20140

Primary Identification (PRI-ID) number

MODEL	PRI-ID
F1K	
YAMAHA MOTOR MANUFACTURING CORPORATION OF AMERICA. ASSEMBLED IN U.S.A. FROM AMERICAN AND JAPANESE COMPONENTS. ASSEMBLÉ AUX ÉTATS-UNIS DE PIÈCES AMÉRICAINES ET JAPONAISES.	

MODEL: VX1100-D (VX110 Sport)
VX1100A-D (VX110 Deluxe)

F1K - [][][][][][][][]

The PRI-ID number is stamped on a label ① attached inside the engine compartment.

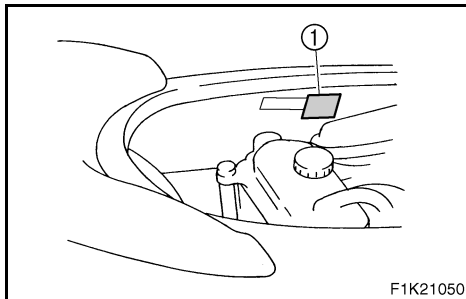

EJU19870

Emission control information (For Canada only)

This engine conforms to 2005 U.S. Environmental Protection Agency (EPA) regulations for marine SI engines.

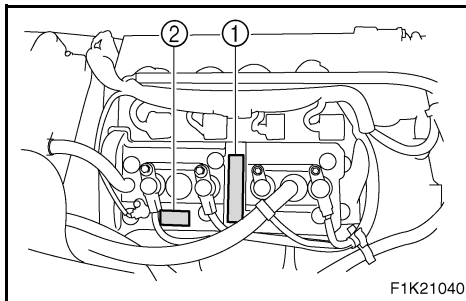

EJU21140

Approval label of emission control certificate

This label is attached to the top of the cylinder head and to the inside of the engine compartment.

① Emission control information label

EMISSION CONTROL INFORMATION		EM
ENGINE FAMILY :		
THIS ENGINE CONFORMS TO :		
THIS ENGINE CONFORMS TO :		
REFER TO THE OWNER'S MANUAL FOR MAINTENANCE SPECIFICATIONS AND ADJUSTMENTS.		
FEL :	g/kW-hr	ADVERTISED POWER :
kW		
DISPLACEMENT :		
cm ³ FUEL : UNLEADED REGULAR GASOLINE		
INFORMATION ANTIPOLLUTION		EM
CATÉGORIE DU MOTEUR :		
CE MOTEUR EST CONFORME AUX NORMES U.S. :		
EPA E - U. POUR MOTEURS NAUTIQUES SI		
CE MOTEUR EST CONFORME AUX NORMES :		
CONCERNANT LES EMISSIONS DE LA CALIFORNIE		
POUR MOTEURS NAUTIQUES SI.		
POUR CONNAITRE LES SPECIFICATIONS ET LES RÉGLAGES / EFFECTUER, CONSULTEZ LE MANUAL		
DU PROPRIÉTAIRE.		
FEL :	g/kW-hr	PUISSANCE AFFICHÉE :
kW		
CYLINDREE :	cm ³	CABURANT : ESSENCE NORMALE SANS PLOMB
YAMAHA MOTOR CO.,LTD.		

EJU17800

Manufactured date label

This label is attached to the top of the cylinder head.

② Manufactured date label

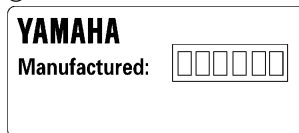



EJU09980

Important labels

EJU13510

Label location

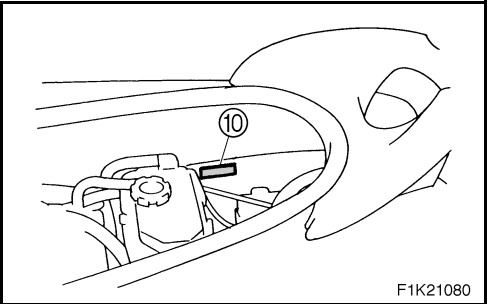
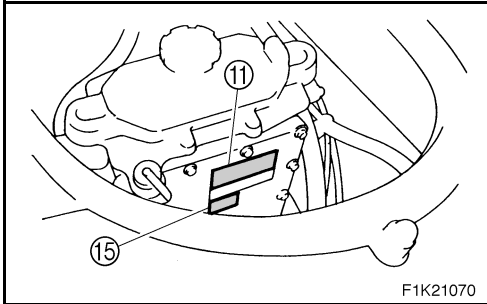
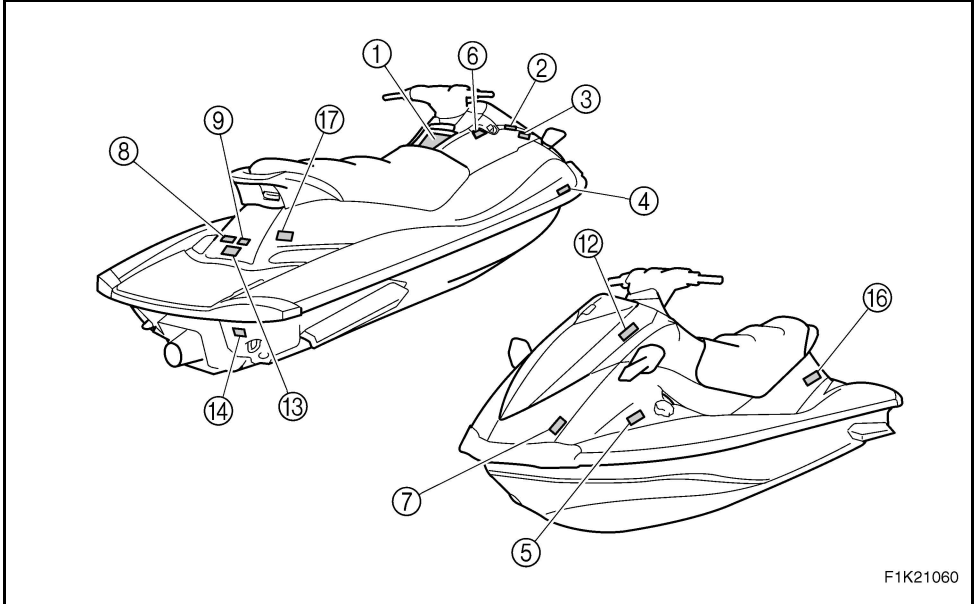



EJU19891

Warning labels

①

⚠ WARNING

To reduce the risk of SEVERE INJURY or DEATH:

WEAR A PERSONAL FLOTATION DEVICE (PFD).

All riders must wear an authority-approved PFD that is suitable for personal watercraft (PWC) use.



PFD

WEAR PROTECTIVE CLOTHING. Severe internal injuries can occur if water is forced into body cavities as a result of falling into water or being near jet thrust nozzle. Normal swimwear does not adequately protect against forceful water entry into rectum or vagina. All riders must wear a wet suit bottom or clothing that provides equivalent protection (See Owner's Manual).



Wet Suit Bottom

Footwear, gloves, and goggles/glasses are recommended.

KNOW BOATING LAWS. Yamaha Motor Co., Ltd. recommends a minimum operator age of 16 years old. Know the operator age and training requirements for your state. A boating safety course is recommended and may be required in your state.

ATTACH ENGINE SHUT-OFF CORD (LANYARD) to wrist and keep it free from handlebars so that engine stops if operator falls off. After riding, remove cord from PWC to avoid unauthorized use by children or others.

RIDE WITHIN YOUR LIMITS AND AVOID AGGRESSIVE MANEUVERS to reduce the risk of loss of control, ejection, and collision. This is a high performance boat - not a toy. Sharp turns or jumping wakes or waves can increase the risk of back/spinal injury (paralysis), facial injuries, and broken legs, ankles, and other bones. **Do not jump wakes or waves.**

DO NOT APPLY THROTTLE WHEN ANYONE IS AT REAR OF PWC - turn engine off or keep engine at idle. Water and/or debris exiting jet thrust nozzle can cause severe injury.

KEEP AWAY FROM INTAKE GRATE while engine is on. Items such as long hair, loose clothing, or PFD straps can become entangled in moving parts resulting in severe injury or drowning.

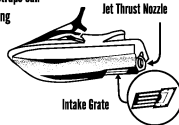

Intake Grate

NEVER RIDE AFTER CONSUMING DRUGS OR ALCOHOL

READ AND FOLLOW OWNER'S MANUAL

⚠ WARNING

Collisions result in more INJURIES AND DEATHS than any other type of accident for personal watercraft (PWC).

TO AVOID COLLISIONS:

SCAN CONSTANTLY for people, objects, and other watercraft. Be alert for conditions that limit your visibility or block your vision of others.

OPERATE DEFENSIVELY at safe speeds and keep a safe distance away from people, objects, and other watercraft.

- Do not follow directly behind PWCs or other boats.
- Do not go near others to spray or splash them with water.
- Avoid sharp turns or other maneuvers that make it hard for others to avoid you or understand where you are going.
- Avoid areas with submerged objects or shallow water.

TAKE EARLY ACTION to avoid collisions. Remember, PWCs and other boats do not have brakes.

DO NOT RELEASE THROTTLE WHEN TRYING TO STEER away from objects - you need throttle to steer.

Always check throttle and steering controls for proper operation before starting PWC.

Follow navigation rules and state/province and local laws that apply to PWCs. See Owner's Manual for more information.



YAMAHA

FIK-U41B1-10



②

▲ AVERTISSEMENT

Afin de limiter les risques de **BLESSURES GRAVES**, voire **MORTELLES**: **PORTER UN GILET DE SAUVETAGE**. Tout utilisateur doit porter un gilet de sauvetage homologué pour les scooters des mers. **PORTER DES VÊTEMENTS PROTÉCTEURS**. Le choc infligé par la pénétration forcée d'eau dans les orifices corporels lors d'une chute ou lors du contact avec le jet d'eau de la pompe risque de provoquer des lésions graves. Le port d'un simple maillot de bain ne constitue pas une protection adéquate contre la puissance de pénétration de l'eau dans le rectum et/ou le vagin. Tout utilisateur doit porter le pantalon d'une tenue de plongée ou tout autre élément offrant une protection semblable. (Voir le manuel d'utilisation.) Le port de chaussures, de gants et de lunettes de plongée est recommandé. **CONNAÎTRE LES LOIS DE NAVIGATION**. La Yamaha Motor Co., Ltd. recommande la limite d'âge de pilotage de 16 ans. Vérifier l'âge du pilote ainsi que les exigences quant à l'âge prévues par la législation locale. Il est préférable, et parfois requis par certaines législations, de suivre un cours de sécurité maritime. **ATTACHER LA LANIÈRE DE L'INTERRUPTEUR D'ARRÊT DU MOTEUR** au poignet et l'éloigner du guidon afin que le moteur se coupe bien en cas de chute. Après utilisation, retirer la lanière du scooter afin de prévenir toute utilisation par des enfants ou des personnes non-autorisées.



YAMAHA

F1B-U41B1-20

③

▲ AVERTISSEMENT

Afin de limiter les risques de **BLESSURES GRAVES**, voire **MORTELLES**:

RESPECTER SES LIMITES ET ÉVITER LES MANŒUVRES BRUTALES afin de limiter tout risque de perte de contrôle, d'éjection et de collision. Il s'agit d'un véhicule à hautes performances et pas d'un jouet. Des virées brusques ou le saut de sillages ou de vagues accroît le risque de blessures au dos, voire de paralysie, de blessures au visage et de fractures diverses. **Ne jamais sauter des sillages ni des vagues.**

NE PAS DONNER DES GAZ LORSQUE QUELQU'UN SE TROUVE DERRIÈRE LE VÉHICULE: couper le moteur ou laisser tourner au ralenti. Eau et/ou débris projetés par la pompe pourraient causer des blessures graves.

NE PAS S'APPROCHER DE LA GRILLE D'ADMISSION lorsque le moteur tourne. Cheveux longs, vêtements amples ou lanières de gilet de sauvetage risquent d'être happés, ce qui pourrait provoquer des blessures, ou même une noyade.

NE JAMAIS PILOTER APRÈS AVOIR ABSORBÉ DE L'ALCOOL, DES DROGUES OU CERTAINS MÉDICAMENTS.

LIRE ET RESPECTER LES INSTRUCTIONS DONNÉES DANS LE MANUEL D'UTILISATION.

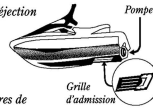

YAMAHA

F1B-U41B1-30

④

▲ AVERTISSEMENT

Les collisions sont la cause principale des **BLESSURES ET DÉCÈS** d'utilisateurs de scooter des mers. **POUR ÉVITER LES COLLISIONS: ÊTRE CONSTAMMENT à l'affût de personnes, d'objets et d'autres bateaux.** Être conscient des conditions limitant sa visibilité ou celle des autres embarcations. **PILOTER AVEC PRUDENCE** à des vitesses raisonnables et garder une distance de sécurité entre le scooter et toute personne, objet et embarcation.

- Ne pas suivre une autre embarcation de trop près.
- Ne pas se rapprocher d'autrui en vue de l'éclabousser.
- Éviter les virages brusques ou toute manœuvre qui risque de mettre un autre pilote en danger ou qui l'empêche de pouvoir déterminer clairement la direction que l'on prend.
- Éviter les endroits où flottent des objets et les eaux peu profondes.

RÉAGIR RAPIDEMENT en vue d'éviter les collisions. Garder à l'esprit que les bateaux n'ont pas de freins.

NE PAS LACHER LES GAZ LORSQUE L'ON ESSAYE DE S'ÉLOIGNER d'objets - une poussée est nécessaire à la direction du scooter des mers. Toujours s'assurer avant le départ que l'accélérateur et la direction fonctionnent correctement. Suivre les lois de navigation ainsi que les législations nationales,

provinciales et locales concernant les scooters des mers.

Voir le manuel d'utilisation pour plus d'informations.

YAMAHA

F1B-U41B2-00



⑤

⚠ WARNING	⚠ AVERTISSEMENT
Gasoline is highly flammable and explosive. A fire or explosion could cause severe injury or death. Shut engine off. Refuel in well ventilated area away from flames or sparks. Do not smoke. Avoid spilling gasoline. Wipe up spilled gasoline immediately. Remove all seats to ventilate fuel vapors from engine compartment before starting engine. Do not start engine if there is a fuel leak or a loose electrical connection.	<i>L'essence est très inflammable et explosive. Un incendie ou une explosion risquent de provoquer des blessures graves, voire mortelles. Couper le moteur. Faire le plein dans un endroit bien aéré et éloigné de toute flamme ou étincelle. Ne pas fumer. Éviter de renverser de l'essence. Essayer immédiatement toute coulure d'essence. Déposer les selles pour évacuer les vapeurs d'essence du compartiment du moteur avant de mettre le moteur en marche. Ne jamais mettre le moteur en marche en cas de fuite d'essence ou si un branchement électrique est desserré.</i>
REGULAR UNLEADED GASOLINE ONLY	ESSENCE NORMALE SANS PLOMB UNIQUEMENT

F1B-U415B-10
F1S-U415B-10

⑥ (For VX110 Deluxe only)

⚠ WARNING
REVERSE SHIFT LEVER OPERATION:
<ul style="list-style-type: none"> • Shift only while engine is idling or off. • Reverse is for low speed maneuvering only. • Do not use reverse function to slow down or stop PWC as it could cause you to lose control, be ejected, or impact handlebars. • Make sure that there are no obstacles or people behind you before shifting to reverse.
⚠ AVERTISSEMENT
FONCTIONNEMENT DU LEVIER D'INVERSION DE MARCHE:
<ul style="list-style-type: none"> • Inverser la marche uniquement lorsque le moteur tourne au ralenti ou lorsqu'il est coupé. • La marche arrière est destinée exclusivement aux manœuvres à vitesse réduite. • Ne pas sélectionner la marche arrière en vue de ralentir ou d'arrêter le scooter des mers, car il y a risque de perte de contrôle, d'éjection ou de heurt sur le guidon. • S'assurer qu'il n'y a ni obstacle ni personne derrière le scooter avant d'engager la marche arrière.

FOV-U4105-30

⑦ (For Europe only)

⚠ AVERTISSEMENT
APPLICABLE POUR LA FRANCE SEULEMENT
<ul style="list-style-type: none"> • En France : permis de conduire et immatriculation obligatoire. • Navigation en mer autorisée entre 300 mètres et 2 milles nautiques. • Entré 0 et 300 mètres, se référer aux instructions nautiques locales affichées. Sinon, règle générale : vitesse maxi 5 noeuds (9Km/h) dans cette zone. • Utiliser les chenaux obligatoires de sortie lorsqu'ils existent. • Respecter les règles de priorité. • Gilet de sauvetage obligatoire-Fusée et bout de remorquage à bord. • Ne jamais conduire sous l'influence de l'alcool ou de drogues. • Consulter la météo avant de sortir en mer. • Une conduite responsable et un contrôle quotidien de votre machine suivant le manuel d'entretien YAMAHA seront garants de votre sécurité.

YAMAHA

GJB-U410H01



8

⚠ WARNING

Do not use cleat or grips to lift PWC. PWC could fall, which could result in severe injury.

⚠ AVERTISSEMENT

Ne pas soulever le scooter à l'aide du taquet ou des poignées. Le scooter pourrait tomber et provoquer des blessures graves.

(FOV-U41E1-40)
(F1S-U41E1-10)

9

⚠ WARNING

- Severe internal injuries can occur if water is forced into body cavities as a result of being near jet thrust nozzle.
- Wear a wetsuit bottom or clothing that provides equivalent protection.
- Do not board PWC if operator is applying throttle.

⚠ AVERTISSEMENT

- Le choc infligé par la pénétration forcée d'eau dans les orifices corporels lors du contact avec le jet de la pompe risque de provoquer des lésions graves.
- Porter le pantalon d'une tenue de plongée ou tout autre vêtement offrant une protection semblable.
- Ne pas embarquer lorsque la pilote donne des gaz.

(FOV-U41E1-40)
(F1S-U41E1-10)

10

⚠ WARNING

Be sure to connect breather hose to battery. Fire or explosion could result if not connected properly.

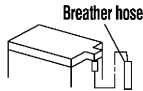
**⚠ AVERTISSEMENT**

Bien veiller à brancher la durit de mise à l'air à la batterie. Un mauvais branchement risque d'être à l'origine d'un incendie ou d'une explosion.

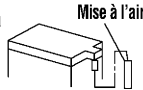

YAMAHA

FOV-U41DB-11

11

⚠ WARNING / AVERTISSEMENT / 警告

Do not touch or remove electrical parts when starting or running the engine.

Ne pas toucher ou retirer les pièces électriques lors du démarrage ou de la marche du moteur.

運転中は電装品には触らないでください。

YAMAHA

6B6-83623-00



EJU19900

Other labels

⑫ (For Canada only)

**FIRE EXTINGUISHER CONTAINER
COMPARTMENT DE L'EXTINCTEUR**

F1B-U41F5-20

⑬

**RATED PERSON CAPACITY: 3
MAXIMUM LOAD: 240 kg (530 lb)
CAPACITÉ MAXIMALE: 3 personnes
CHARGE MAXIMALE: 240 kg(530 lb)**

(F0V-U41E1-40)
(F1S-U41E1-10)

⑭

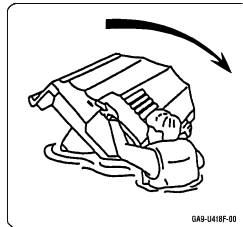

GAB-U41BF-00



15 (For Europe only)

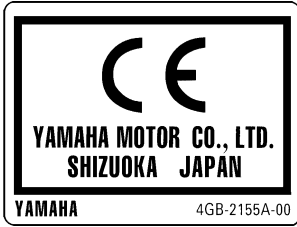

16 (For Canada only)

This spark ignition system meets all requirements of the Canadian Interference Causing Equipment Regulations.
Ce système d'allumage par étincelle de véhicule respecte toutes les exigences du Règlement sur le matériel brouilleur du Canada.

YAMAHA

GJ3-U419E-00
F1S-U419E-00

17 (For Canada only)

Fisheries and Oceans Canada Coast Guard		
BUILDER - CONSTRUCTEUR	MODEL - MODELE	
YAMAHA MOTOR CANADA LTD. (YAM)	WAVE RUNNER [] []	
THE MANUFACTURER CERTIFIES THAT THIS PRODUCT COMPLIES WITH THE CONSTRUCTION STANDARDS FOR SMALL VESSELS.	LE FABRICANT CERTIFIE QUE CE PRODUIT EST CONFORME AUX NORMES DE CONSTRUCTION DES PETITS BATEAUX.	
<div style="border: 1px solid black; padding: 5px; display: inline-block;">NO. - no</div>		



EJU09990



Safety information

The safe use and operation of this watercraft is dependent upon the use of proper riding techniques, as well as upon the common sense, good judgment, and expertise of the operator. Before using this watercraft, make sure that its use is permitted under local laws, bylaws and regulations and always operate the watercraft in full conformity with any requirements and limitations imposed. Every operator should know the following requirements before riding the watercraft.

- Before operating the watercraft, read this Owner's/Operator's Manual, the Riding Practice Guide, and all warning and caution labels on the watercraft. These materials should give you an understanding of the watercraft and its operation.
- Never allow anyone to operate this watercraft until they too have read this Owner's/Operator's Manual, the Riding Practice Guide and all warning and caution labels.

EJU12070

Limitations on who may operate the watercraft

- Yamaha recommends a minimum operator age of 16 years old. Adults must supervise use by minors. Know your local operator age and training requirements.



- This watercraft is designed to carry the operator and up to 2 passengers. Never exceed the maximum load limit or allow more than 3 persons (or 2 persons if a water-skier is being pulled) to ride the watercraft at one time.

Maximum load: 240 kg (530 lb)
Load is the total weight of cargo,
operator and passengers.

- Do not operate the watercraft with any passengers on board until you have considerable practice and experience riding alone. Operating the watercraft with passengers requires more skill. Take the time to become accustomed to the handling characteristics of the watercraft before trying any difficult maneuvers.



EJU10010

Cruising limitations

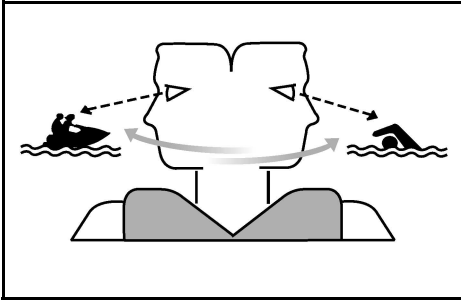

- Scan constantly for people, objects, and other watercraft. Be alert for conditions that limit your visibility or block your vision of others.
- Operate defensively at safe speeds and keep a safe distance away from people, objects, and other watercraft.
- Do not follow directly behind watercraft or other boats.
- Do not go near others to spray or splash them with water.
- Avoid sharp turns or other maneuvers that make it hard for others to avoid you or understand where you are going.
- Avoid areas with submerged objects or shallow water.
- Ride within your limits and avoid aggressive maneuvers to reduce the risk of loss of control, ejection, and collision.
- This is a high performance boat—not a toy. Sharp turns or jumping wakes or waves can increase the risk of back/spinal injury (paralysis), facial injuries, and broken legs, ankles and other bones. Do not jump wakes or waves.

- Do not operate the watercraft in rough water, bad weather or when visibility is poor; this may lead to an accident causing injury or death. Be alert to the possibility of adverse weather. Take note of weather forecasts and the prevailing weather conditions before setting out on your watercraft.
- As with any water sport, you should not ride your watercraft without someone else near by. If you ride further than swimming distance from shore, you should ride by another boat or watercraft, but make sure you stay a safe distance away. It's good common sense!

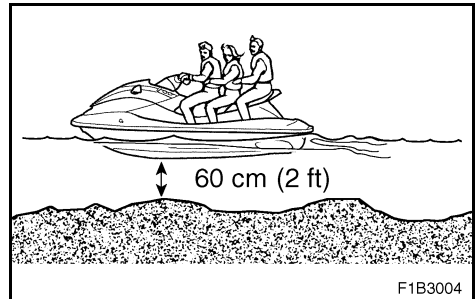

- Never operate in water that is less than 60 cm (2 ft) deep, otherwise you increase your chance of hitting a submerged object, which could result in injury.



- This watercraft is not equipped with lighting required for night operation. Do not operate the watercraft after sunset or before dawn, otherwise you increase the risk of colliding with another boat, which could result in severe injury or death.

EJU12083

Operation requirements

- All riders must wear a personal flotation device (PFD) that is approved by the appropriate authorities and suitable for personal watercraft use.
- Wear protective clothing. Severe internal injuries can occur if water is forced into body cavities as a result of falling into water or being near the jet thrust nozzle. Normal swimwear does not adequately protect against forceful water entry into rectum or vagina. All riders must wear a wetsuit bottom or clothing that provides equivalent protection. Such clothing includes thick, tightly woven, sturdy and snug-fitting apparel such as denim, but does not include spandex or similar fabrics, like those used in bicycle shorts.

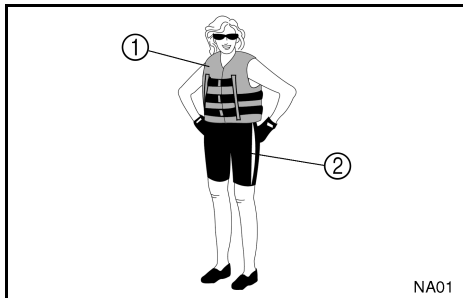

- ① Authority-approved PFD
- ② Wetsuit bottom
- Eye protection is recommended to keep wind, water, and glare from the sun out of your eyes while you operate your watercraft. Restraining straps for eyewear are made which are designed to float should your eyewear fall in the water. Footwear and gloves are recommended.



- You must decide whether to wear a helmet while you ride for recreation. You should know that a helmet could help protect you in certain kinds of accidents and that it could injure you in others.

A helmet is designed to provide some head protection. Although helmets cannot protect against all foreseeable impacts, a helmet might reduce your injuries in a collision with a boat or other obstacle.

A helmet may have potential safety hazards, as well. Falling into the water could risk the chance of the helmet catching water, commonly known as “bucketing,” and the resulting strain on your neck could cause choking, severe and permanent neck injuries, or death. A helmet could also increase the risk of an accident if it reduces your vision or hearing, or if it distracts you or increases your fatigue.

How should you decide if a helmet’s potential safety benefits outweigh its potential risks for you? Consider your particular riding conditions. Consider factors such as your riding environment and your riding style and ability. Also consider the likelihood of traffic congestion, and the water surface conditions. If you decide to wear a helmet based upon your riding circumstances, choose one carefully. Look for a helmet designed for personal watercraft use, if possible. If you will be engaging in closed-course competition, follow the helmet requirements of the sanctioning organization.



- NEVER operate the watercraft after consuming alcohol or taking other drugs.
- For reasons of safety and proper care of the watercraft, always perform the pre-operation checks listed on page 3-5 before operating the watercraft.
- The operator and passengers should always keep both feet in the footwell when the watercraft is in motion. Lifting your feet increases your chances of losing your balance, and your feet being hit by objects outside the watercraft. Do not give a ride to children if their feet cannot reach the floor of the footwell.

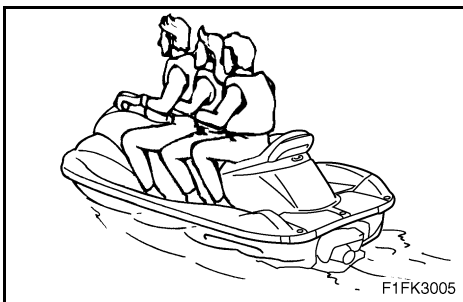

- The passengers should hold on firmly, either to the person in front of them or to the handgrip provided.
- Always consult your doctor on whether it is safe for you to ride this watercraft if you are pregnant or in poor health.



- Do not attempt to modify this watercraft! Modifications to your watercraft may reduce safety and reliability, and render the watercraft unsafe or illegal for use.

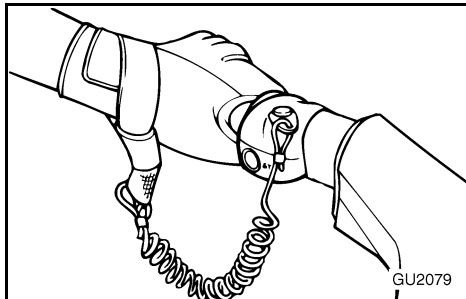

- Attach the engine shut-off cord (lanyard) to wrist and keep it free from the handlebars so that the engine stops if the operator falls off. After riding, remove the engine shut-off cord from the watercraft to avoid accidental starting or unauthorized use by children or others.
- Scan carefully for swimmers and stay away from swimming areas. Swimmers are hard to see and you could accidentally hit someone in the water.
- Avoid being hit by another boat! You should always take the responsibility to watch for traffic; other boaters may not be watching for you. If they do not see you, or you maneuver more quickly than other boaters expect, you risk a collision.
- Maintain a safe distance from other boats or watercraft, and also watch for boats' ski ropes or fishing lines. Obey the "Safe boating rules," and be sure to check behind you before making a turn. (See Safe boating rules on page 1-20.)

EJU13820

Recommended equipment

The following items should be carried on board your watercraft:

- Sound-signaling device
You should carry a whistle or other sound-signaling device that can be used to signal other boats.
- Visual distress signals
It is recommended that an authority-approved pyrotechnic device be stored in a waterproof container on your watercraft. A mirror can also be used as an emergency signal. Contact your Yamaha dealer for more information.
- Watch
A watch is helpful so you will know how long you have been operating.
- Towline
A towline can be used to tow a disabled watercraft in an emergency.



EJU17810

Hazard information

- Never start the engine or let it run for any length of time in an enclosed area. Exhaust fumes contain carbon monoxide, a colorless, odorless gas that may cause loss of consciousness and death within a short time. Always operate the watercraft in an open area.
- Hot oil tank, muffler, and engine surfaces can cause serious burns. Do not touch the oil tank, muffler, or engine immediately after turning the engine off.

EJU21150

Watercraft characteristics

- Jet thrust turns the watercraft. Releasing the throttle lever completely produces only minimum thrust. If you are traveling at speeds above trolling, you will have rapidly decreasing ability to steer without throttle. This model has the Yamaha Engine Management System (YEMS) that includes an Off-Throttle Steering (OTS) system. It will activate at planing speeds should you attempt to steer the watercraft after releasing the throttle lever. The OTS system assists in turning by continuing to supply some thrust while the watercraft is decelerating, but you can turn more sharply if you apply throttle while turning the handlebars. The OTS system does not function below planing speeds or when the engine is off. Once the engine slows down, the watercraft will no longer turn in response to handlebar input until you apply throttle again or you reach trolling speed. Practice turning in an open area without obstructions until you have a good feel for this maneuver.
- This watercraft is water-jet propelled. The jet pump is directly connected to the engine. This means that jet thrust will produce some movement whenever the engine is running. There is no “neutral” position. You are in either “forward” or “reverse,” depending upon the shift lever position (for VX110 Deluxe).



- For VX110 Deluxe:
Do not use the reverse function to slow down or stop the watercraft as it could cause you to lose control, be ejected, or impact the handlebars. You could also damage the shift mechanism.
This could increase the risk of back/spinal injury (paralysis), facial injuries, and broken legs, ankles, and other bones.

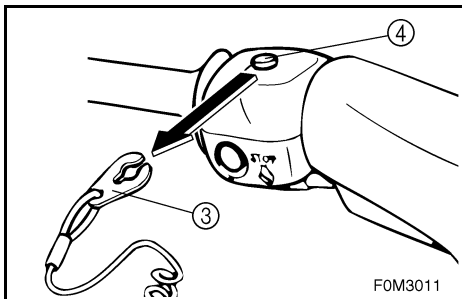

- For VX110 Deluxe:
Reverse can be used to slow down or stop during slow-speed maneuvering, such as when docking. Once the engine is idling, shift into reverse and gradually increase engine speed. Make sure that there are no obstacles or people behind you before shifting into reverse.
- Keep away from the intake grate ① while the engine is on. Items such as long hair, loose clothing, or PFD straps can become entangled in moving parts resulting in severe injury or drowning.
- Never insert any object into the jet thrust nozzle ② while the engine is running. Severe injury or death could result from coming in contact with the rotating parts of the jet pump.

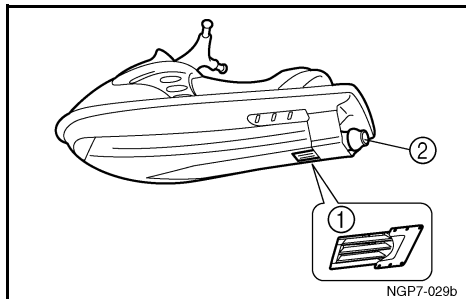

- Stop the engine and remove the clip ③ from the engine shut-off switch ④ before removing any debris or weeds, which may have collected around the jet intake.



EJU18630

Water-skiing

You can use the watercraft for water-skiing if it has the seating capacity to carry the operator, a rearward-facing spotter, and the water-skier when he or she is not skiing.

The watercraft must also have a cleat ① designed to pull a ski towrope; do not attach the towrope to any other location.

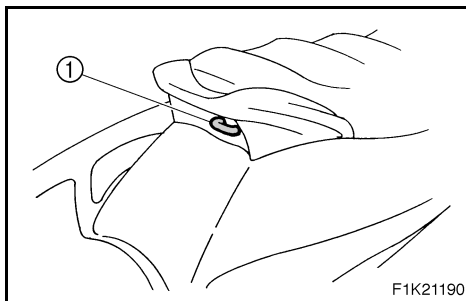

It is the watercraft operator's responsibility to be alert to the safety of the water-skier and others. Know and follow all local water-skiing regulations in effect for the waters in which you will be operating.

The operator should be comfortable carrying passengers before attempting to pull a skier.

The following are some important considerations for minimizing risks while water-skiing.

- The skier should wear an approved PFD, preferably a brightly colored one so boat operators can see the skier.
- The skier should wear protective clothing. Severe internal injuries can occur if water is forced into body cavities as a result of falling into the water. Normal swimwear does not adequately protect against forceful water entry into rectum or vagina. The skier should wear a wetsuit bottom or clothing that provides equivalent protection.

- A second person should be on board as a spotter to watch the skier; in many places it is required by law. Let the skier direct the operator's control of speed and direction with hand signals.

The spotter should sit securely on the passenger seat and hold onto the hand-grip ② with feet firmly on the floor of the footwell for proper balance while facing to the rear to watch the skier's hand signals and his or her condition.

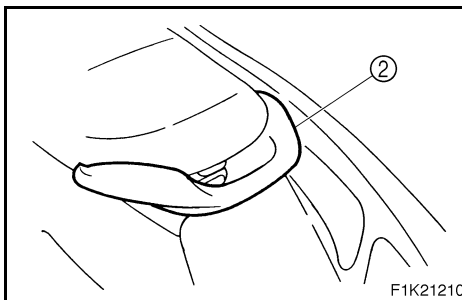
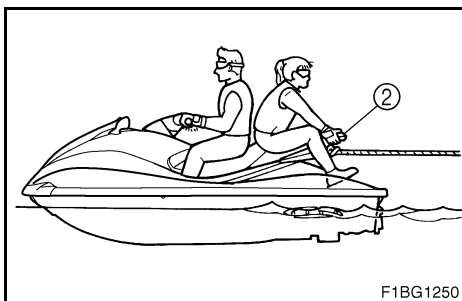



- Your control while pulling a skier is affected by the skier's ability, as well as water and weather conditions.
- When preparing to pull a skier, operate the watercraft at the slowest possible speed until the watercraft is well away from the skier and slack in the towrope is taken up. Make sure that the rope is not looped around anything.
After checking that the skier is ready and that there is no traffic or other obstacles, apply enough throttle to raise the skier.
- Make smooth, wide turns. The watercraft is capable of very sharp turns, which could exceed the abilities of the skier. Keep the skier at least 50 m (150 ft), about twice the distance of a standard towrope, from any potential hazard.
- Be alert to the hazard of the towrope handle snapping back at the watercraft when the skier falls or is unable to get up on the skis.
- Towing heavy or bulky objects other than skiers, such as another boat or watercraft, can cause loss of steering control and create a hazardous condition. If you must tow another boat in an emergency situation, operate slowly and cautiously.



Safe boating rules

Your Yamaha watercraft is legally considered a powerboat. Operation of the watercraft must be in accordance with the rules and regulations governing the waterway on which it is used.

Enjoy your watercraft responsibly

You share the areas you enjoy when riding your watercraft with others and with nature. So your enjoyment includes a responsibility to treat these other people, and the lands, waters, and wildlife with respect and courtesy.

Whenever and wherever you ride, think of yourself as the guest of those around you. Remember, for example, that the sound of your watercraft may be music to you, but it could be just noise to others. And the exciting splash of your wake can make waves others won't enjoy. Avoid riding close to shoreline homes and waterfowl nesting areas or other wildlife areas, and keep a respectful distance from fishermen, other boats, swimmers, and populated beaches. When travel in areas like these is unavoidable, ride slowly and obey all laws.

Remember that pollution can be harmful to the environment. Do not refuel or add oil where a spill could cause damage to nature. Remove your watercraft from the water and move it away from the shoreline before refueling. And keep your surroundings pleasant for the people and wildlife that share the waterways: don't litter!

When you ride responsibly, with respect and courtesy for others, you help ensure that our waterways stay open for the enjoyment of a variety of recreational opportunities.



-MEMO-

EJU10070

FEATURES AND FUNCTIONS



Location of main components2-1

Operation of controls and other functions	2-5
Seat	2-5
Hood	2-6
Fuel tank filler cap	2-6
Remote control transmitter (for VX110 Deluxe)	2-7
Engine stop switch	2-9
Engine shut-off switch	2-9
Start switch	2-10
Throttle lever	2-10
Cooling water pilot outlet	2-11
Steering system	2-12
Shift lever (for VX110 Deluxe)	2-13
Handgrip	2-14
Yamaha Engine Management System (YEMS)	2-15
Yamaha Security System/Low-RPM mode (for VX110 Deluxe)	2-15
Multifunction meter	2-18
Storage compartments	2-24



EJU10080

Location of main components

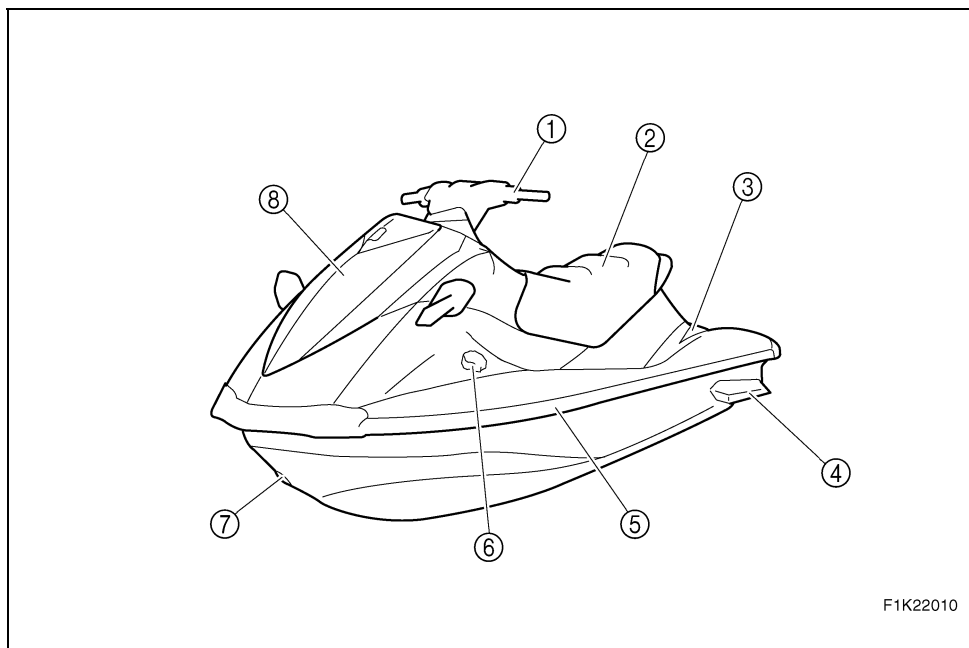

F1K22010

- ① **Handlebars**
Use to control direction.
- ② **Seat**
- ③ **Footwell**
Use to place feet for balance.
To keep proper balance while facing to the rear to watch the skier.
- ④ **Sponsons**
- ⑤ **Gunwale**
- ⑥ **Fuel tank filler cap**
- ⑦ **Bow eye**
Use to attach rope for transporting, mooring or towing the watercraft in an emergency.
- ⑧ **Hood**

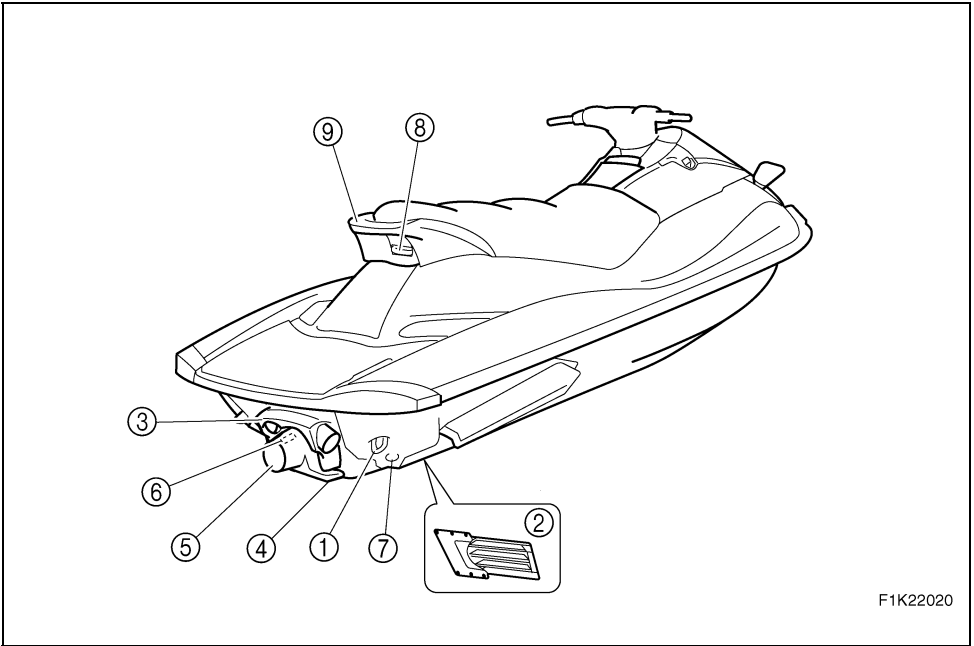

F1K22020

- ① **Stern eye**
Use to attach rope for transporting or mooring.
- ② **Intake grate**
Prevents debris from getting into the jet pump.
- ③ **Reverse gate (VX110 Deluxe)**
Controls direction of jet thrust when in reverse.
- ④ **Ride plate**
- ⑤ **Jet thrust nozzle**
Changes the direction of jet thrust according to handlebar position.
- ⑥ **Speed sensor**
- ⑦ **Stern drain plugs**
Use to drain water in the bilge when the watercraft is on dry land.
- ⑧ **Cleat**
Use to attach a towrope for pulling water-skier, or a rope for mooring the watercraft.
- ⑨ **Handgrip**
Use for support when boarding the watercraft or when seated facing rearward and acting as a spotter for a water-skier.

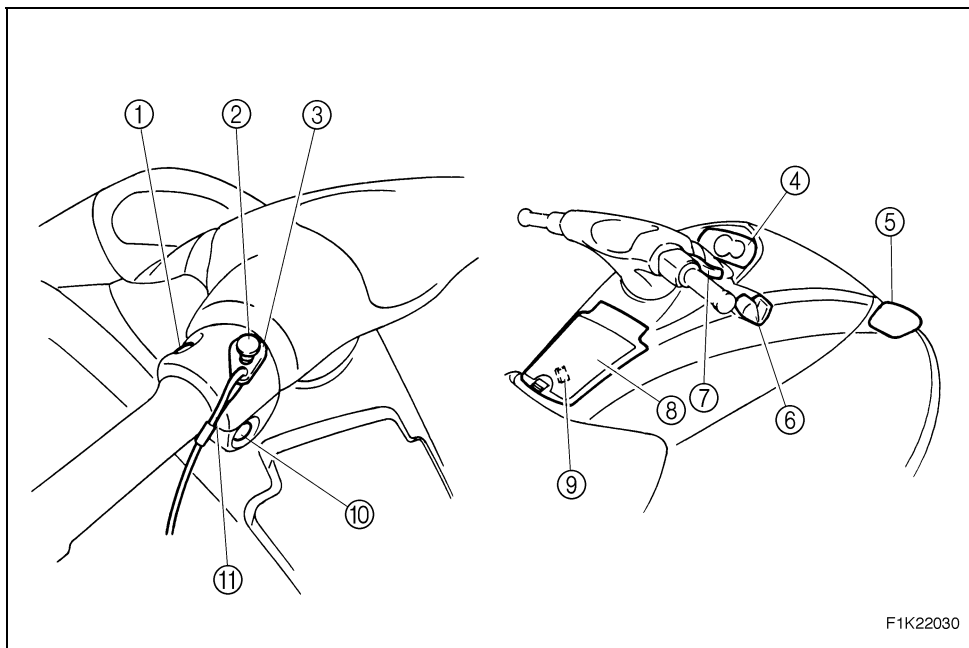

F1K22030

- ① **Start switch**
Push to start the engine.
- ② **Engine shut-off switch**
Remove the clip to stop the engine and disable it from starting.
- ③ **Clip**
Insert into the engine shut-off switch to enable starting of the engine.
Remove to stop the engine or prevent accidental starting of the engine or unauthorized use of the watercraft.
- ④ **Multifunction meter**
Use to check watercraft operation.
- ⑤ **Rearview mirrors (VX110 Deluxe)**
- ⑥ **Shift lever (VX110 Deluxe)**
Use to put the watercraft into forward or reverse.
- ⑦ **Throttle lever**
Use to accelerate and decelerate.
- ⑧ **Glove compartment**
- ⑨ **Remote control transmitter (VX110 Deluxe)**
- ⑩ **Engine stop switch**
Push to stop the engine normally.
- ⑪ **Engine shut-off cord (lanyard)**
Attach to wrist so that the engine stops if the operator falls off the watercraft.

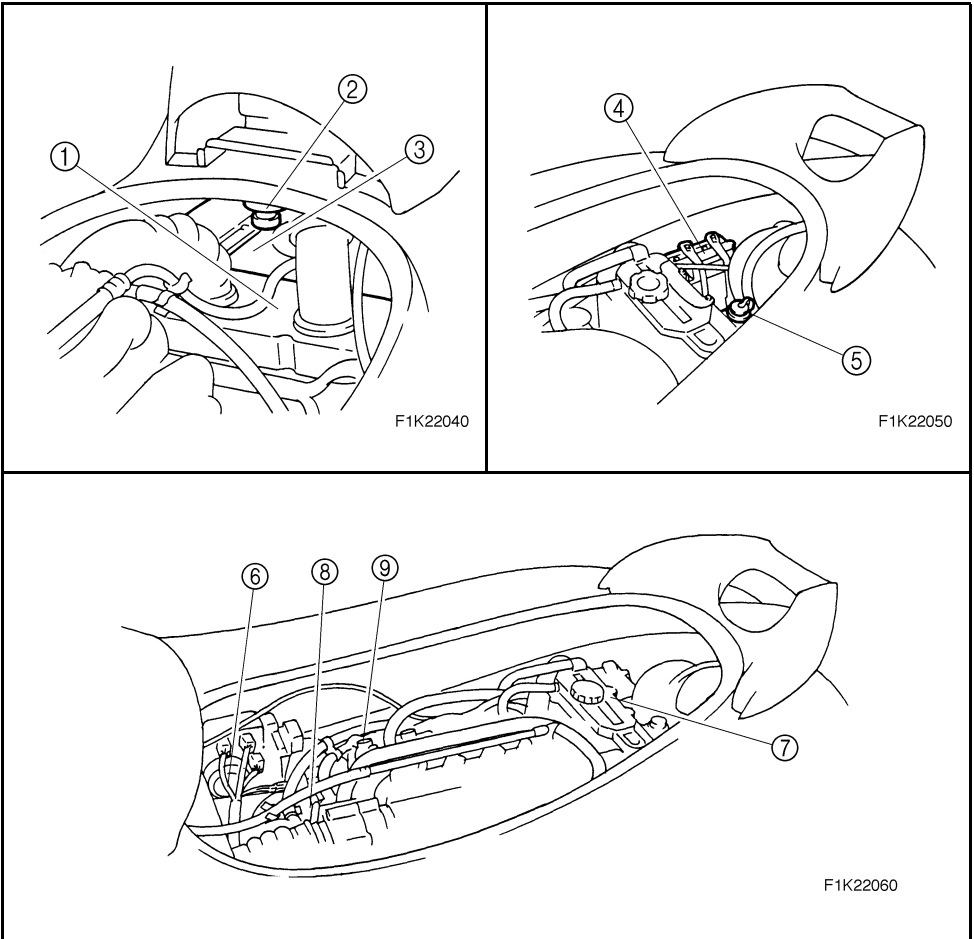

- ① **Air filter case**
- ② **Water separator**
- ③ **Fuel tank**
- ④ **Battery**
- ⑤ **Flush hose connector**
Use to flush the engine cooling water passages.
- ⑥ **Electrical box**
Protects electrical components from water.
- ⑦ **Oil tank**
- ⑧ **Muffler**
- ⑨ **Spark plugs/Spark plug caps/ignition coils**

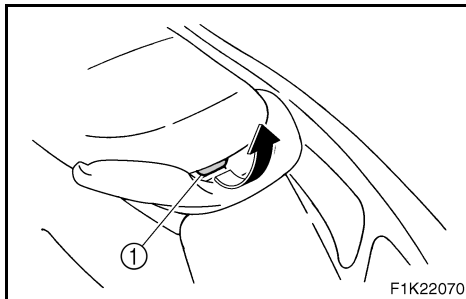

EJU10090

Operation of controls and other functions

EJU10100

Seat

There is a seat latch ① at the rear of the seat to remove the seat.

To remove the seat:

Pull the seat latch up, and then pull the seat off.

To install the seat:

Insert the projection on the front of the seat into the stay on the deck, and then push the rear of the seat down to lock it in place securely.

NOTE:

Make sure that the seat is properly secured before operating the watercraft.

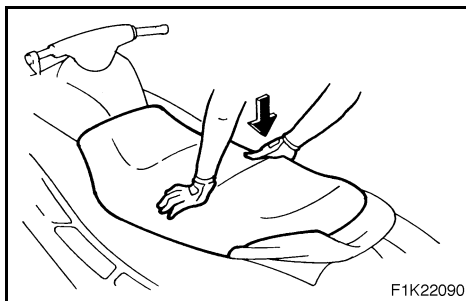
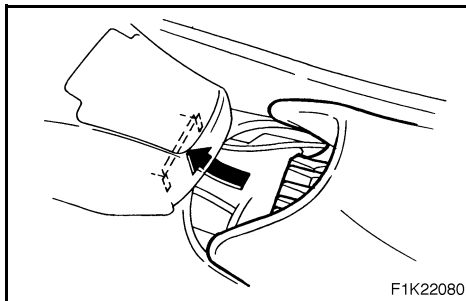

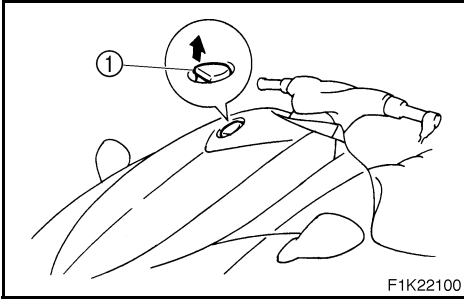

EJU12130

Hood

To open the hood, pull the latch ① up, and then lift the hood up.

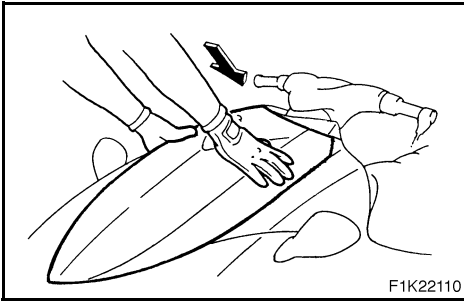

To close the hood, push the hood down to lock it in place.

NOTE: _____
Make sure that the hood is properly secured before operating the watercraft.

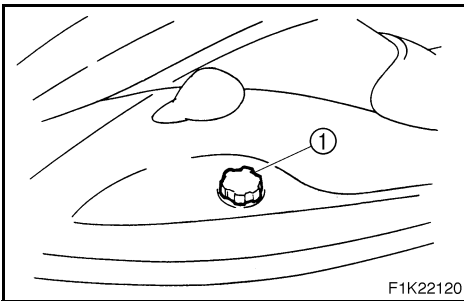

EJU10120

Fuel tank filler cap

To remove the fuel tank filler cap ①, turn it counterclockwise.

NOTE: _____
Make sure that the fuel tank filler cap is properly secured before operating the watercraft.



EJU21111

Remote control transmitter (for VX110 Deluxe)

The Yamaha Security System and low-RPM mode settings are selected using the remote control transmitter. (See “Yamaha Security System/Low-RPM mode” on page 2-15 for information on using the remote control transmitter.)

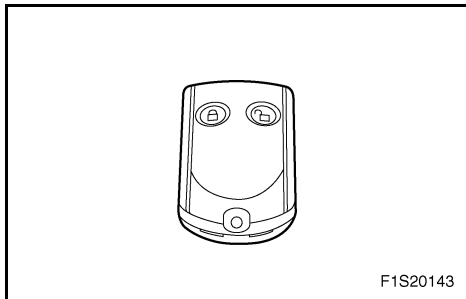

CAUTION:

The Yamaha Security System and low-RPM mode settings can only be selected using the remote control transmitter. Observe the following precautions to protect your remote control transmitter:

- Store the remote control transmitter carefully so it will not be lost. When operating the watercraft, use the transmitter holder ① in the glove compartment. If you accidentally lose your remote control transmitter, contact a Yamaha dealer.
- While the remote control transmitter has been designed for use in wet environments, it should not be operated under water or submerged for an extended length of time. If it gets wet, dry it with a soft, dry cloth.
- Keep the remote control transmitter away from high temperatures and do not place it in direct sunlight.
- Do not drop the remote control transmitter, subject it to strong shocks, or place any heavy items on it.
- Use a soft, dry cloth to clean the transmitter. Do not use detergent, alcohol, or other chemicals.
- If the remote control transmitter needs a new battery or is not operating properly, contact a Yamaha dealer. Do not attempt to replace the battery yourself.

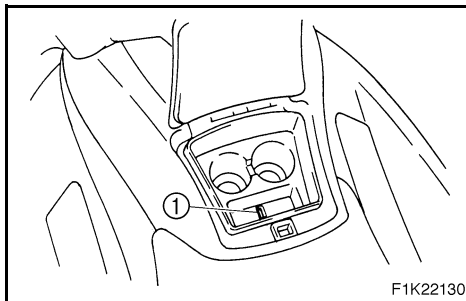



NOTE: _____
While the engine is running, input from the remote control transmitter is not received.

For Canada only

IC (Industry Canada) rules:

Operation is subject to the following two conditions; (1) this device may not cause interference, and (2) this device must accept any interference received including interference that may cause undesired operation of the device.

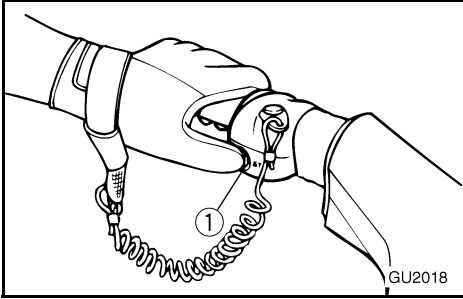

EJU10150

Engine stop switch

Push this switch ① (red button) to stop the engine normally.

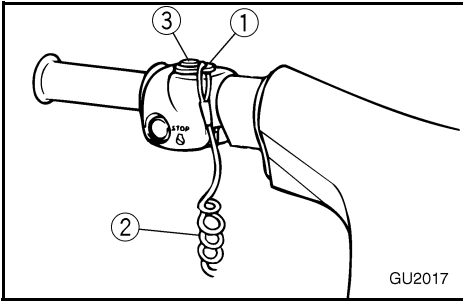

EJU10160

Engine shut-off switch

Insert the clip ①, on the end of the engine shut-off cord ②, under the engine shut-off switch ③ (black button). The engine will stop automatically when the clip is removed from the switch, such as if the operator falls off the watercraft.

⚠WARNING

- Always attach the engine shut-off cord to your wrist and the clip to the engine shut-off switch **BEFORE** starting the engine.
- To prevent accidental starting of the engine or unauthorized use by children or others, always remove the clip from the shut-off switch when the engine is not running.

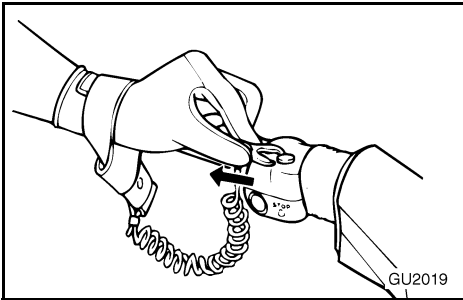

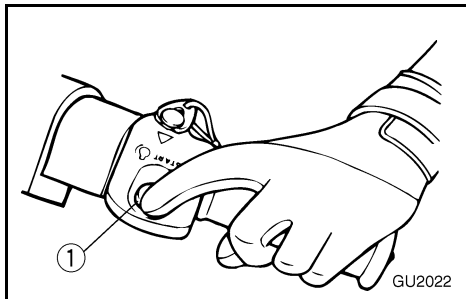

EJU21160

Start switch

Push the start switch ① (green button) to start the engine.

NOTE: _____

The engine will not start when the lock mode of the Yamaha Security System has been selected (for VX110 Deluxe) or the clip is removed from the engine shut-off switch. (See page 2-15 for Yamaha Security System and low-RPM mode selection procedures.)

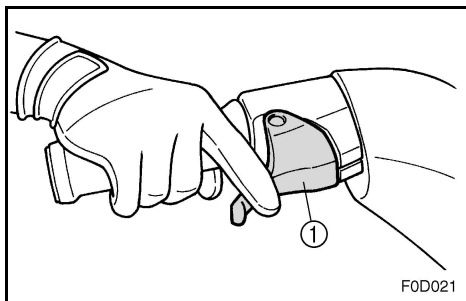

EJU10180

Throttle lever

Squeeze the throttle lever ① to increase engine speed.

Release the throttle lever to decrease engine speed or to return it to the idle position.

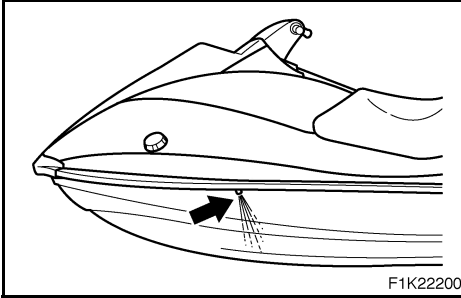

EJU11301

Cooling water pilot outlet

This watercraft is equipped with a cooling water pilot outlet.

When the engine is running, cooling water is circulated in the engine, and then it is discharged from the pilot outlet.

To check for proper operation of the cooling system, check that water is being discharged from the pilot outlet. If water is not being discharged from the outlet, cooling water may not be circulating in the engine. When this occurs, stop the engine and check for the cause. (See pages 2-22 and 5-3 for more information.)

NOTE:

- If the cooling water passages are dry, it will take about 60 seconds for the water to reach the outlet after the engine is started.
- Water discharge may not be constant at idle, therefore, open the throttle a little to check that water discharges properly.



EJU19950

Steering system

Your watercraft can be steered by turning the handlebars ① in the direction you wish to travel.

When the handlebars are turned, the angle of the jet thrust nozzle ② is changed and the direction of the watercraft is changed accordingly. Since the strength of the jet thrust determines the speed and degree of a turn, throttle must always be applied when attempting a turn, except at trolling speed.

This model has the Yamaha Engine Management System (YEMS) that includes an Off-Throttle Steering (OTS) system. It will activate at planing speeds should you attempt to steer the watercraft after releasing the throttle lever. The OTS system assists in turning by continuing to supply some thrust while the watercraft is decelerating, but you can turn more sharply if you apply throttle while turning the handlebars. The OTS system does not function below planing speeds or when the engine is off. Once the engine slows down, the watercraft will no longer turn in response to handlebar input until you apply throttle again or you reach trolling speed.

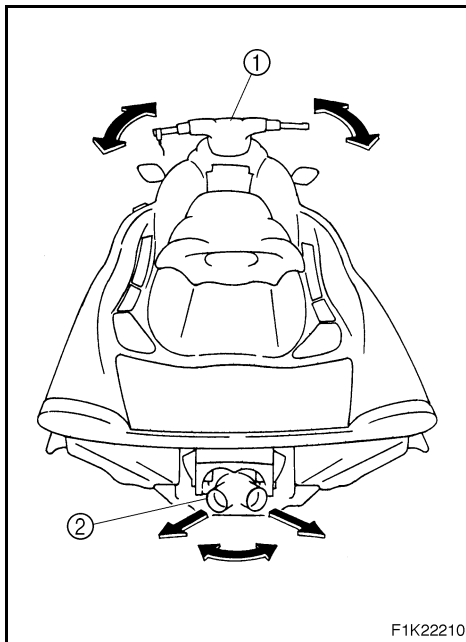

F1K22210



EJU18771

Shift lever (for VX110 Deluxe)

The shift lever is located on the starboard (right) side of the watercraft and is used to control the reverse gate, which allows the watercraft to move in reverse or forward.

When the shift lever is in the reverse position, the watercraft can be launched from a trailer, or backed up out of tight spots where you cannot turn around easily.

To shift into reverse:

1. Release the throttle and let the engine speed return to idle.
2. Pull the shift lever toward you.

⚠WARNING

- **Make sure that the throttle is completely released and that the engine is at idle before shifting into reverse.**
- **Do not use the reverse function to slow down or stop the watercraft as it could cause you to lose control, be ejected, or impact the handlebars.**
- **Use reverse for slow-speed maneuvering only.**
- **Make sure that there are no obstacles or people behind you before shifting into reverse.**
- **Do not touch the reverse gate while the shift lever is being operated, otherwise you could be pinched.**

To shift into forward:

1. Release the throttle and let the engine speed return to idle.
2. Push the shift lever away from you.

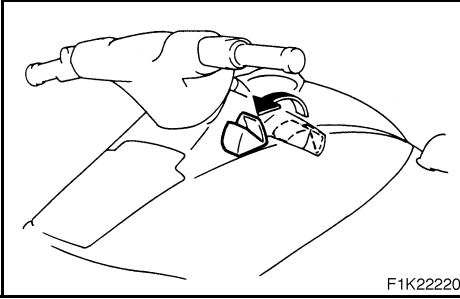

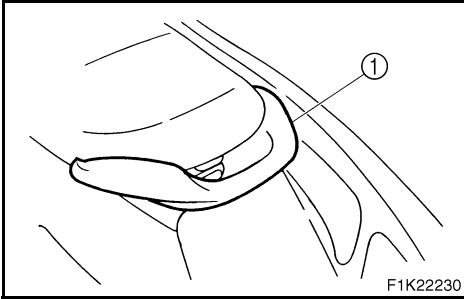

EJU19670

Handgrip

The handgrip ① provides a handhold for boarding the watercraft and for a spotter when facing rearward.

⚠WARNING

Do not use the handgrip to lift the watercraft. The watercraft could fall, which could result in severe injury.



EJU19940

Yamaha Engine Management System (YEMS)

This model is equipped with an integrated, computerized management system that controls and adjusts ignition timing, fuel injection, engine diagnostics, and the Off-Throttle Steering (OTS) system.

EJU20723

Yamaha Security System/ Low-RPM mode (for VX110 Deluxe)

This watercraft is equipped with a remote control transmitter ① that is used to select the security system and low-RPM mode settings. Since the watercraft is programmed to recognize the internal code from this transmitter only, the security system setting can only be changed with this transmitter. If you lose the remote control transmitter or it does not operate properly, contact a Yamaha dealer.

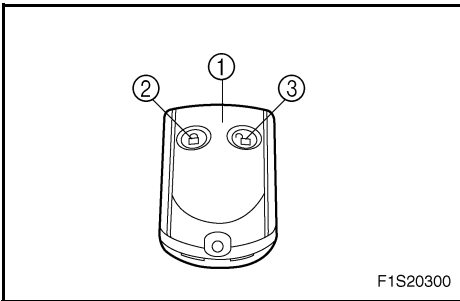

EJU21561

Yamaha Security System (for VX110 Deluxe)

The Yamaha Security System functions to help prevent unauthorized use or theft of the watercraft. The engine cannot be started if the security system is in the lock mode. The engine can only be started in the unlock mode.



EJU21571

Yamaha Security System lock and unlock modes (for VX110 Deluxe)

The lock and unlock modes of this system can only be selected while the engine is stopped.

When the lock button ② is pressed, the beeper sounds once. This indicates the lock mode is selected and the engine cannot be started.

The “SECURITY” indicator light ④ comes on when the security system is in the unlock mode and goes off when the security system is in the lock mode.

When the unlock button ③ is pressed for a short time, the beeper sounds two times for the normal mode or three times for the low-RPM mode. The “SECURITY” indicator light will come on and the engine can be started. (See the items in “Selecting the normal mode/low-RPM mode” for operation mode information.)

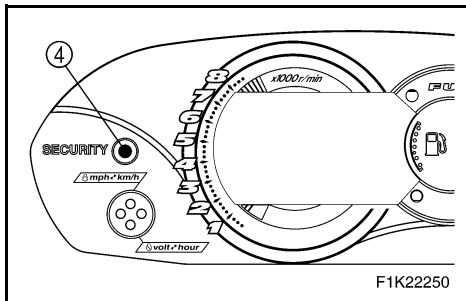
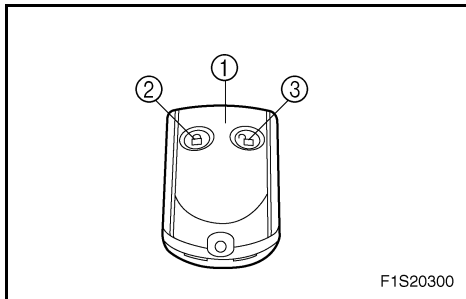

Number of beeps	Yamaha Security System mode	Engine can be started
1 beep	Lock	NO
2 beeps	Unlock (normal mode)	YES
3 beeps	Unlock (low-RPM mode)	YES



EJU21581

Selecting the normal mode/ low-RPM mode (for VX110 Deluxe)

The normal mode and low-RPM mode can only be selected when the engine is stopped in the unlock mode. Press the unlock button for more than 4 seconds to select the normal mode or low-RPM mode.

Normal mode

If the beeper sounds twice, the normal mode is activated.

The watercraft can be ridden normally.

Low-RPM mode

If the beeper sounds three times, the low-RPM mode is activated and the "L-MODE" indicator light ⑤ comes on.

Maximum engine speed (r/min) in the low-RPM mode is limited to approximately 90% of the maximum engine speed in the normal mode.

NOTE:

- If neither the start switch nor the remote control transmitter is operated within 25 seconds after the unlock button is pressed to select the unlock mode, the multifunction meter display and the "L-MODE" indicator light will go off. To change the modes again, press the lock button briefly to select the lock mode, and then press the unlock button again for less than 4 seconds to select the unlock mode.
- While the engine is running, input from the remote control transmitter is not received.

CAUTION:

If the remote control transmitter does not operate when its buttons are pressed, the battery may be low. Have a Yamaha dealer replace the battery.

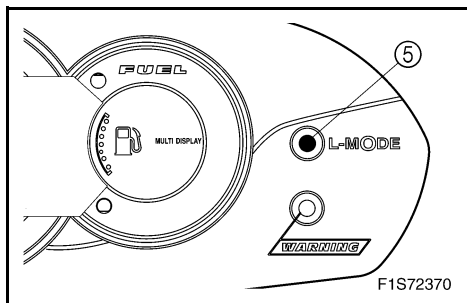



EJU20731

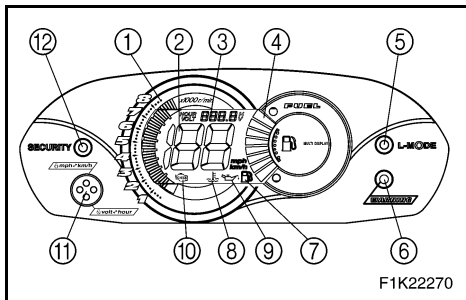

Multifunction meter

This meter contains the following functions for help and convenience in operating the watercraft.

- ① Tachometer
- ② Speedometer
- ③ Hour meter/Voltmeter
- ④ Fuel meter
- ⑤ “L-MODE” indicator light (for VX110 Deluxe)
- ⑥ Warning light
- ⑦ Fuel warning indicator
- ⑧ Engine overheat warning indicator
- ⑨ Oil pressure warning indicator
- ⑩ Check engine warning indicator
- ⑪ Select button
- ⑫ “SECURITY” indicator light (for VX110 Deluxe)

CAUTION:

Do not run the engine for more than 15 seconds when checking the operation of the meter on land. The engine could overheat.

NOTE:

- When the engine is started, all displays light up for 2 seconds and then the meter starts to operate normally.
- The current display will continue to operate for 25 seconds after the engine stops.

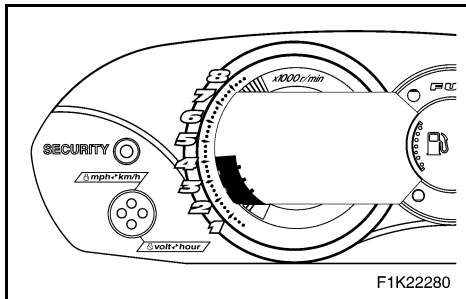

EJU17870

Tachometer

The engine speed (r/min) is displayed by segments. Each segment indicates a 250 r/min increment.

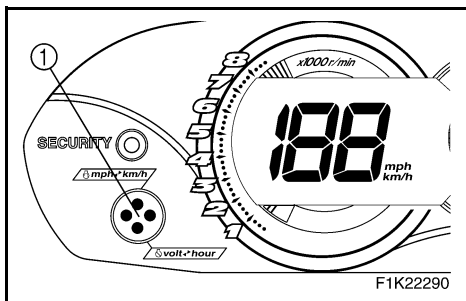

EJU20740

Speedometer

The meter shows the watercraft speed against water.

NOTE: _____
To switch the speedometer display between kilometers and miles, push the select button ① for at least 1 second, within 10 seconds after the meter is displayed.

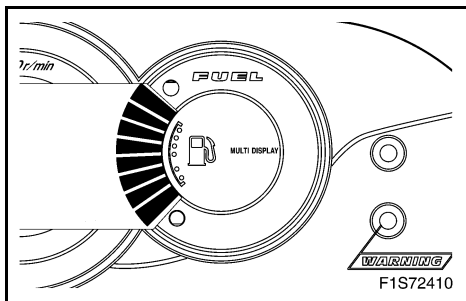

EJU17890

Fuel meter

The fuel meter is provided for convenient fuel level checking while riding. The fuel meter has eight segments which show the amount of fuel remaining in the fuel tank.

NOTE: _____
The fuel level is most accurate when the watercraft is sitting level on a trailer or in the water.



EJU21171

Hour meter/Voltmeter

NOTE:

To switch the display between the hour meter and voltmeter, push the select button ① for at least 1 second after the meter is displayed for more than 10 seconds.

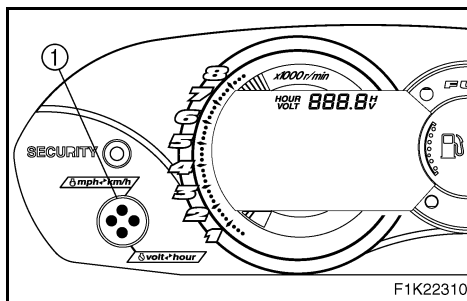

Hour meter

The hour meter is provided to make it easy to follow the maintenance schedule.

The meter shows the hours of engine operation that have elapsed since the watercraft was new.

Voltmeter

The voltmeter is provided to display the voltage of the battery.

When the battery voltage is normal, the voltmeter displays approximately 12 volts.

If the battery voltage is less than 8.0 volts, “LO” is displayed on the voltmeter and if the voltage is above 18.1 volts, “HI” is displayed on the voltmeter. If “HI” or “LO” is displayed, beach the watercraft and, if necessary, have a Yamaha dealer check the charging system and the battery.

EJU20760

Check engine warning indicator

If a sensor malfunction or a short circuit is detected, the warning light and the check engine warning indicator begin to blink and the buzzer sounds intermittently.

If this occurs, reduce the engine speed, beach the watercraft, and have a Yamaha dealer check the engine.

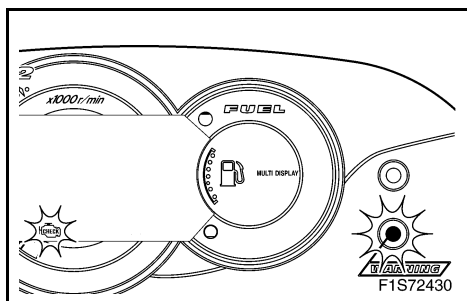

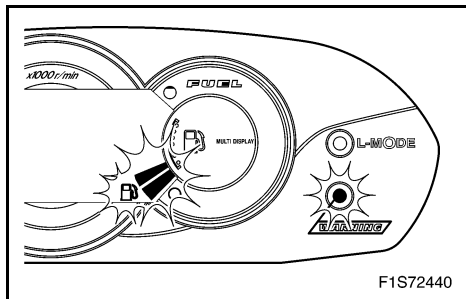

EJU20770

Fuel warning indicator

If the fuel remaining in the tank drops to about 13 L (3.4 US gal, 2.9 Imp gal), the lowest two fuel level segments, the fuel warning indicator, and the warning light all begin to blink. The buzzer also starts sounding intermittently.

The warning signals will be cleared when the engine is restarted after refilling.

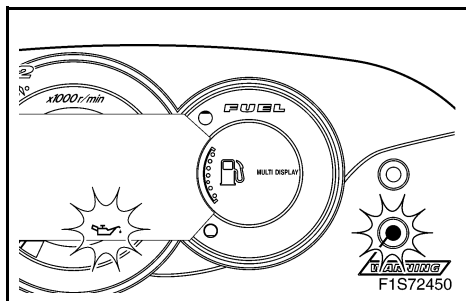

EJU20782

Oil pressure warning indicator

If the oil pressure does not rise to specification, the warning light and the oil pressure warning indicator begin to blink and the buzzer sounds intermittently. At the same time, the engine speed is limited to help prevent damage.

If this occurs, reduce the engine speed, beach the watercraft, and then check the engine oil level. (See page 3-7 for engine oil level checking procedures.) If the oil level is low, add enough engine oil to raise it to the proper level. If the oil level is sufficient, have a Yamaha dealer check the watercraft.

NOTE: _____
Press the select button ① on the multifunction meter to stop the buzzer.

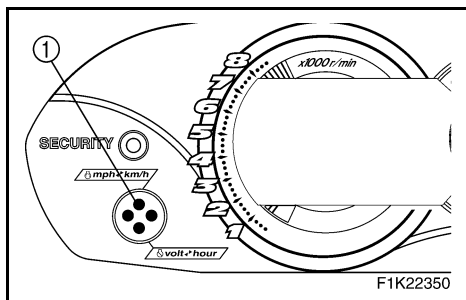



EJU21182

Engine overheat warning indicator

This model is equipped with an engine overheat warning system.

If the engine starts to overheat, the warning light and the overheat warning indicator blink, and then come on. The buzzer also begins to sound intermittently, and then it sounds continuously. After the light and indicator start to blink and the buzzer sounds, the engine speed is limited to help prevent damage.

If this occurs, immediately reduce the engine speed, beach the watercraft, and then check for water discharge at the port (left) cooling water pilot outlet. If there is no discharge of water, check the intake grate and impeller for clogging.

⚠ WARNING

Before attempting to remove weeds or debris from the intake grate or impeller, shut the engine off and remove the clip from the engine shut-off switch. Severe injury or death could result from coming in contact with the rotating parts of the jet pump.

CAUTION:

If you cannot locate and correct the cause of the overheating, consult a Yamaha dealer. Continuing to operate at higher speeds could result in severe engine damage.

NOTE:

Press the select button ① on the multifunction meter to stop the buzzer.

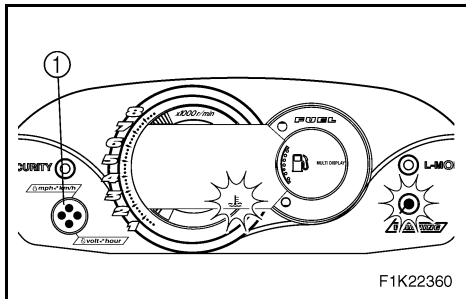

F1K22360

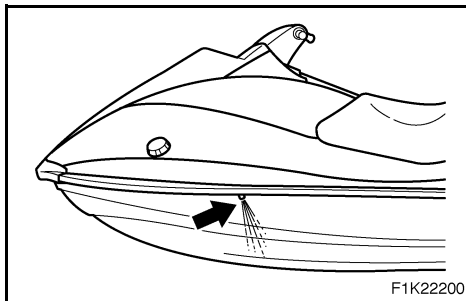

F1K22200

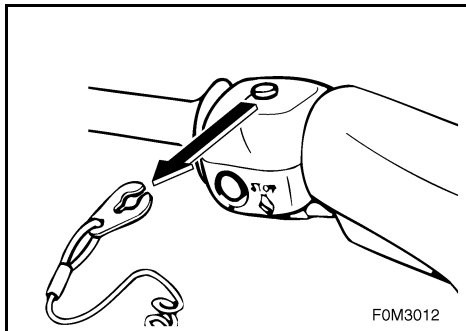

F0M3012

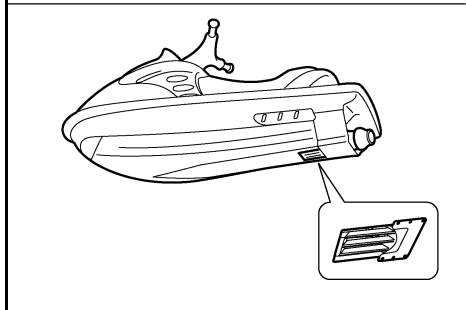

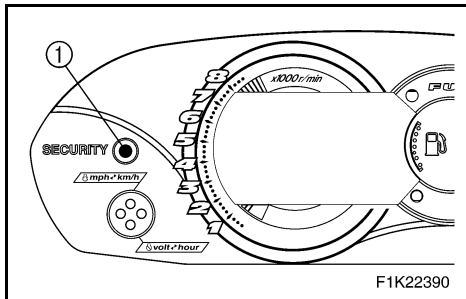

EJU20801

“SECURITY” indicator light (for VX110 Deluxe)

The “SECURITY” indicator light ① comes on when the unlock mode of the Yamaha Security System is selected. The watercraft can be ridden normally when this light is on. (See page 2-15 for more information.)

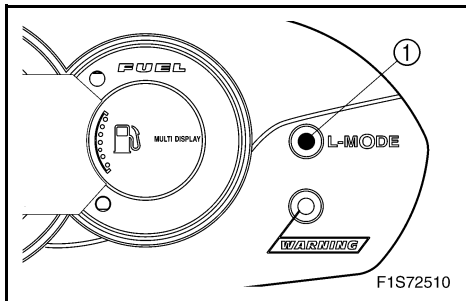

EJU20811

“L-MODE” indicator light (for VX110 Deluxe)

The “L-MODE” indicator light ① comes on when the low-RPM mode is selected. (See page 2-15 for more information.)

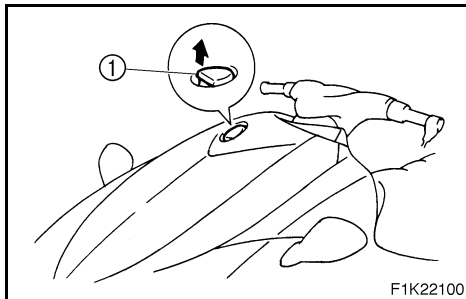

EJU10350

Storage compartments

A front storage compartment and a glove compartment are provided.

NOTE: _____

- Make sure that the storage compartments are properly secured before operating the watercraft.
- The storage compartments are not designed to be waterproof. If you carry objects that must be kept dry, such as the manuals, put them in a waterproof bag.

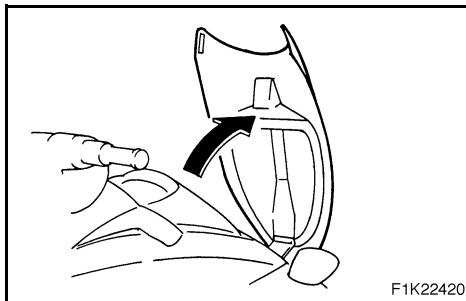

EJU21190

Front storage compartment

The front storage compartment (2) is located at the bow.

To open the front storage compartment, pull the hood latch (1) up, and then open the hood.

To close the front storage compartment, push down on the rear of the hood until it latches securely.

NOTE: _____

Make sure that the front storage compartment is properly secured before operating the watercraft.

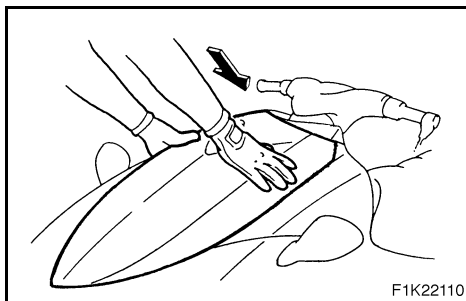
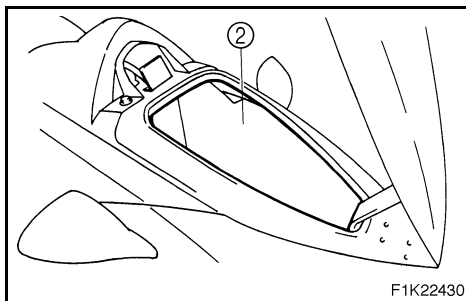

Front storage compartment: Capacity: 62.0 L (16.4 US gal, 13.6 Imp gal) Load limit: 5.0 kg (11 lb)

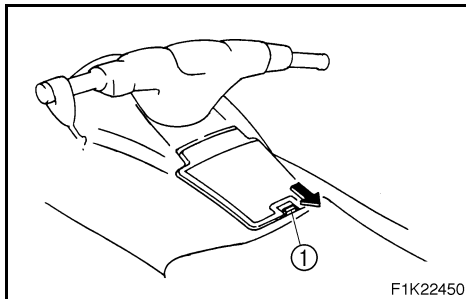

EJU20821

Glove compartment

A glove compartment ② is located in front of the seat.

To open the glove compartment, slide the latch ① toward you, and then lift up the lid.

To close the glove compartment, push the lid down until it locks securely.

Glove compartment:
Capacity: 5.2 L (1.4 US gal, 1.1 Imp gal)
Load limit: 1.0 kg (2.2 lb)

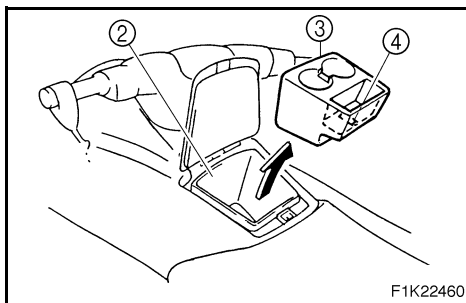

For VX110 Deluxe

NOTE: _____

- A removable beverage holder ③, which includes a transmitter holder ④, is provided in the glove compartment. Do not place beverages in the beverage holder when operating the watercraft.
- Keep the remote control transmitter in the transmitter holder when operating the watercraft.

OPERATION

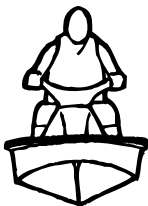

Fuel and oil	3-1
Gasoline	3-1
Engine oil	3-3
Filling the fuel tank	3-4
Pre-operation checks	3-5
Pre-operation check list	3-5
Pre-operation check points	3-6
Operation	3-15
Engine break-in	3-15
Launching the watercraft	3-16
Starting the engine	3-17
Stopping the engine	3-19
Leaving the watercraft	3-19
Operating your watercraft	3-20
Getting to know your watercraft	3-20
Learning to operate your watercraft	3-20
Riding watercraft with passengers	3-21
Starting the watercraft	3-22
Boarding and starting in deep water	3-24
Capsized watercraft	3-27
Turning the watercraft	3-29
Stopping the watercraft	3-31
Beaching the watercraft	3-32
Docking the watercraft	3-32
Reverse on waterways (for VX110 Deluxe)	3-33
Rough water operation	3-33
Post-operation checks	3-34
Transporting	3-36



Fuel and oil

This watercraft is equipped with a 4-stroke engine. Conventional 2-stroke engine oil cannot be used.

The engine utilizes an electronic fuel injection system to deliver the optimal air-fuel mixture ratio required by the engine. With optimal combustion conditions, this system is able to increase startability and improve fuel economy.

Gasoline

⚠WARNING

GASOLINE AND ITS VAPORS ARE HIGHLY FLAMMABLE AND EXPLOSIVE!

- Do not smoke when refueling, and keep away from sparks, flames, or other sources of ignition.
- Stop engine before refueling.
- Refuel in a well-ventilated area with the watercraft in a horizontal position.
- Do not stand or sit on the watercraft while refueling in case of fire.
- Take care not to spill gasoline. If gasoline spills, wipe it up immediately with dry rags. Always properly dispose of gasoline-soaked rags.
- Avoid overfilling the fuel tank. Stop filling when the fuel level reaches approximately 50 mm (2 in) from the top of the fuel tank. Fuel expands as it warms up and could overflow if the fuel tank has been overfilled. If temporarily leaving the watercraft with a full fuel tank, do not leave it in direct sunlight. Leave it in a well-ventilated area with the watercraft in a horizontal position.



- Tighten the filler cap securely after refueling.
- If you should swallow some gasoline, inhale a lot of gasoline vapor, or get gasoline in your eyes, get immediate medical attention.
- If any gasoline spills onto your skin, immediately wash with soap and water. Change clothing if gasoline spills on it.

CAUTION:

Use only fresh gasoline that has been stored in clean containers.

Recommended gasoline:

Regular unleaded gasoline with a minimum octane rating of

86 (Pump octane number) = $(R+M)/2$

90 (Research octane number)

EJU18320

Gasohol

There are two types of gasohol: gasohol containing ethanol and that containing methanol.

Gasohol containing ethanol can be used if ethanol content does not exceed 10% and the fuel meets minimum octane ratings.

Gasohol containing methanol is not recommended by Yamaha because it can cause fuel system damage or engine performance problems.



EJU17990

Engine oil

Use a combination of the recommended SAE and API oil classifications shown in the chart below.

SAE		API		
-4	32	68	104 °F	SE SF SG SH SJ SL
-20	0	20	40 °C	
10W-30				
20W-40				
20W-50				F1K23010

CAUTION:

Use only 4-stroke engine oil.



EJU21200

Filling the fuel tank

CAUTION:

Be careful when refueling. Avoid getting water or other contaminants in the fuel tank. Contaminated fuel can cause poor running or engine damage.

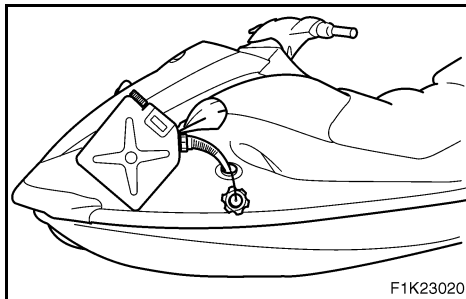

1. Remove the seat. (See page 2-5 for seat removal and installation procedures.)
2. Remove the fuel tank filler cap, and then slowly add fuel to the fuel tank.
3. Stop filling when the fuel level reaches approximately 50 mm (2 in) from the top of the fuel tank as indicated (a) in the illustration.

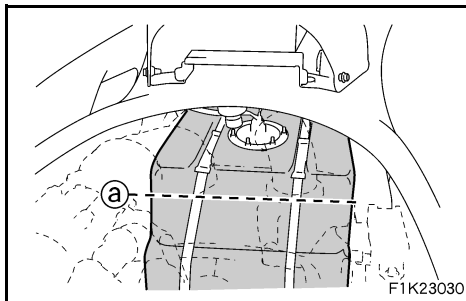

Fuel tank capacity:
60.0 L (15.9 US gal, 13.2 Imp gal)



EJU13460

Pre-operation checks

EJU13470

Pre-operation check list

Before operating this watercraft, perform the checks in the following check list. See the accompanying text in this chapter for details on how to perform the checks.

⚠ WARNING

If any item in the pre-operation check list is not working properly, have it inspected and repaired before operating the watercraft, otherwise an accident could occur.

ITEM	ROUTINE	PAGE
Engine compartment	Remove the seat to ventilate the engine compartment. Check for fuel vapors and loose electrical connections.	3-6
Bilge	Check for water and fuel and remove if necessary.	3-9
Stern drain plugs	Check for proper installation.	3-9
Throttle lever	Check that the throttle lever springs back smoothly.	3-11
Steering system	Check for proper operation.	3-12
Shift lever and reverse gate (VX110 Deluxe)	Check for proper operation.	3-12
Fuel and oil	Check fuel and oil levels and add if necessary. Check the hoses and tanks for leakage.	3-6, 3-7
Water separator	Check for water and drain if necessary.	3-8
Battery	Check electrolyte level, battery terminal connections, breather hose connection, and battery condition.	3-10
Hood	Check that the hood is properly secured.	2-6
Seat	Check that the seat is properly secured.	2-5
Hull and deck	Check the hull and deck for cracks or other damage.	3-6
Jet unit	Check for debris and remove if necessary.	3-13
Fire extinguisher	Check condition and replace if necessary.	3-11
Engine shut-off cord	Check condition and replace if frayed or broken.	3-13
Switches	Check the start switch, engine stop switch, and engine shut-off switch for proper operation.	3-14
Cooling water pilot outlet	Check that water is discharged while the engine is running and the watercraft is in the water.	3-14
Multifunction meter	Check for warning indications and proper operation.	3-14

NOTE:

Pre-operation checks should be made thoroughly each time the watercraft is used. This procedure can be completed in a short time. It is worth the time spent to assure safety and reliability.

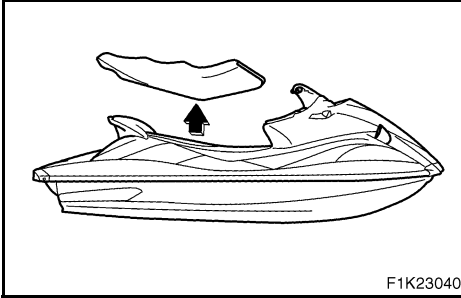

EJU10480

Pre-operation check points

EJU21210

Engine compartment

Ventilate the engine compartment before each use.

To ventilate the engine compartment, remove the seat. (See page 2-5 for seat removal and installation procedures.) Leave the engine compartment open for a few minutes to allow any fuel vapors to escape.

While the engine compartment is open, check for loose electrical connections.

⚠WARNING

Failure to ventilate the engine compartment could result in fire or explosion. Do not start the engine if there is a fuel leak or a loose electrical connection.

EJU20570

Hull and deck

Check the hull and deck for cracks or other damage. If any damage is found, have a Yamaha dealer repair the watercraft.

EJU21220

Fuel level

Check the fuel system for leakage, cracks, or malfunctions before each use. (See page 4-10 for check points and correct procedures.)

1. Remove the fuel tank filler cap to release any pressure that might have built up in the fuel tank.
2. Remove the seat. (See page 2-5 for seat removal and installation procedures.)
3. Check the fuel level in the tank and replenish if necessary. (See page 3-4 for filling instructions.)



EJU21230

Engine oil level

Check the engine oil level before each use.

CAUTION:

- When checking the engine oil level on water, be careful of other watercraft, boats, swimmers, and obstacles. The water current and wind can cause the watercraft to move and lead to a collision.
- When checking the engine oil level on land, supply water to the cooling water passages. (See page 4-1 for procedures on supplying water.)
- Make sure that the engine has enough oil but do not overfill it. If there is too little oil, the engine can be damaged. If there is too much oil, the air filter can become saturated with oil, permanently damaging the filter and reducing engine performance. Follow the checking procedure carefully.
- Make sure that debris and water do not enter the oil tank filler hole. Debris and water in the engine oil can cause serious engine damage.

To check the engine oil level:

1. Place the watercraft in a horizontal position or launch the watercraft, and then start the engine.
2. Run the engine at trolling speed for 6 minutes or more, and then stop the engine.

NOTE:

If the ambient temperature is 20 °C (68 °F) or less, warm up the engine for an additional 5 minutes.

3. Remove the seat. (See page 2-5 for seat removal and installation procedures.)

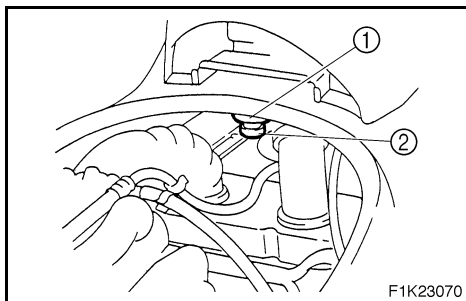
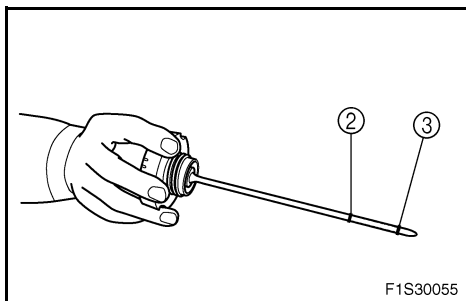
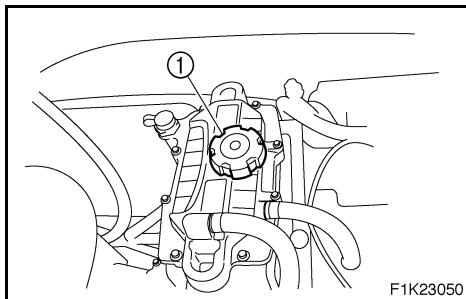

4. Remove the oil tank filler cap ①, wipe the dipstick clean, and then screw the filler cap into the filler hole completely. Remove the filler cap again and check that the oil level is between the minimum level mark ③ and maximum level mark ② on the dipstick.
5. If the oil level is below the minimum level mark, add enough oil so that the oil level is between the minimum and maximum level marks on the dipstick, and then install the filler cap. If the engine oil level is significantly above the maximum level mark, the oil tank is overfilled. Have a Yamaha dealer remove the excessive amount of engine oil.

EJU19610

Water separator

Check the water separator ① for water. Normally the water separator is empty. The water separator retains any water entering through the fuel tank breather hose if the watercraft is capsized.

If water remains in the water separator, drain it by removing the drain screw ②. Place a drain pan under the water separator to catch the draining water or use a dry cloth to soak up any water that could spill into the watercraft. If any water spills into the watercraft, be sure to wipe it up with a dry cloth. Be sure to install the drain screw after draining the water separator.



EJU21490

Bilge

Check for moisture and fuel residue in the bilge.

Excessive water in the bilge can splash into the engine which could cause engine damage.

To remove water from the bilge:

1. Remove the stern drain plugs.
2. Raise the bow of the watercraft until the water drains.
3. After the water has drained, wipe the bilge with dry rags to make sure that the bilge is thoroughly dry.
4. Install the drain plugs.

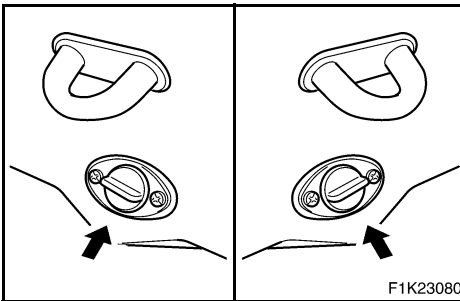

EJU20581

Stern drain plug

Check the stern drain plugs for proper installation.

CAUTION:

- Make sure that the stern drain plugs are tightened securely before launching the watercraft. Otherwise, water may flood the engine compartment and cause the watercraft to submerge.
- Clean any foreign materials, such as dirt or sand, from the drain plug threads before installing the drain plugs. Otherwise, the drain plugs may be damaged and water may enter the engine compartment.



EJU19690

Battery

Check the battery condition and the electrolyte level.

Check that the battery leads are tightened securely and there is no corrosion on the battery terminals.

⚠WARNING

- **The battery must always be fully charged and in good condition. Loss of battery power may leave you stranded. Never operate the watercraft if the battery does not have sufficient power to start the engine or if it shows any other signs of decreased power.**
- **Be sure to connect the breather hose to the battery. Fire or explosion could result if the breather hose is damaged, obstructed, or not connected properly.**

Make sure that the battery is securely held in place.

- ① Positive (+): Red lead
- ② Negative (-): Black lead
- ③ Breather hose

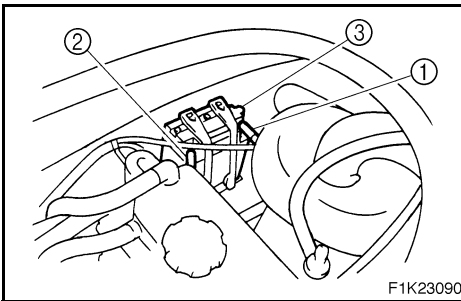

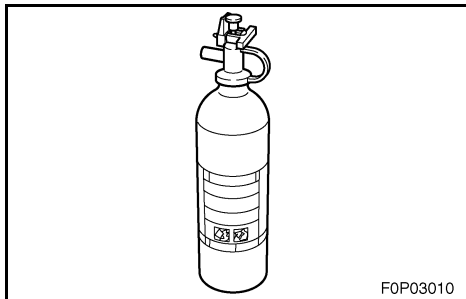

EJU21240

Fire extinguisher

Check that there is a full fire extinguisher on board. The fire extinguisher holder and cover ① are located in the front storage compartment.

To store the fire extinguisher, unhook the band ② and remove the cover. Place the fire extinguisher in the holder, and then place the cover over the fire extinguisher. Fasten the cover and the fire extinguisher with the band securely.

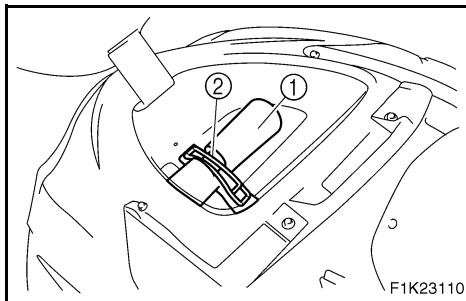

NOTE:

- See the instructions supplied by the fire extinguisher manufacturer for checking the fire extinguisher. Always keep the extinguisher secured in the holder with its cover in place.
- Always carry a fire extinguisher on board. A fire extinguisher is not standard equipment with this watercraft. If you do not have one, contact a Yamaha dealer or a fire extinguisher dealer to obtain one meeting the proper specifications.

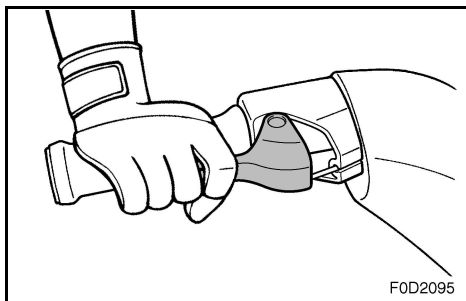

EJU18340

Throttle

Squeeze and release the throttle lever several times to make sure that there is no hesitation in its travel. It should be smooth over the complete range, and spring back to the idle position when released.

⚠WARNING

Before starting the engine, always check the operation of the throttle lever.

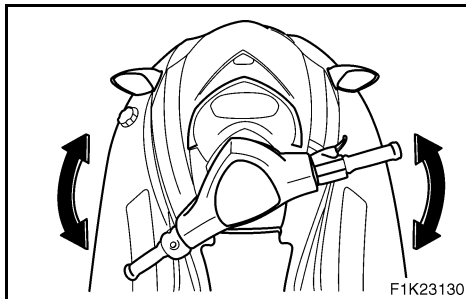

F1K23130

EJU10570

Steering system

Check for looseness in the handlebars.

Turn them as far as possible to the right and left to make sure that operation is smooth and unrestricted throughout the whole range. Make sure that the jet thrust nozzle also changes directions as the handlebars are turned, and that there is no free play between the handlebars and the jet thrust nozzle.

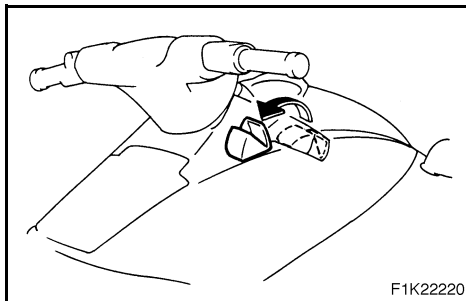

F1K22220

EJU12451

Shift lever and reverse gate (for VX110 Deluxe)

Check for proper operation of the shift lever and reverse gate.

Make sure that the reverse gate goes down completely when the shift lever is pulled up.

Also, make sure that the reverse gate goes up completely when the shift lever is pushed down.

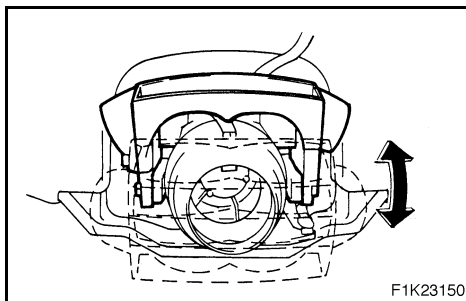

F1K23150

⚠ WARNING

- Make sure that the throttle is completely released and that the engine is at idle before shifting into reverse.
- Do not use the reverse function to slow down or stop the watercraft as it could cause you to lose control, be ejected, or impact the handlebars.
- Use reverse for slow-speed maneuvering only.
- Make sure that there are no obstacles or people behind you before shifting into reverse.
- Do not touch the reverse gate while the shift lever is being operated, otherwise you could be pinched.

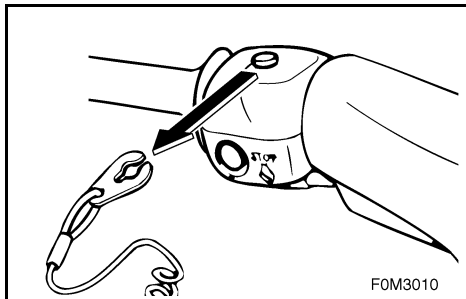

EJU10580

Jet unit

Carefully check the jet intake for weeds, debris, or anything else that might restrict the intake of water. If the intake is clogged, cavitation could occur, reducing jet thrust, and possibly damaging the jet pump.

In some cases, the engine may overheat because of lack of cooling water, and damage to the engine could result. Engine cooling water is fed to the engine by the jet pump. (See page 5-3 for jet intake cleaning procedures.)

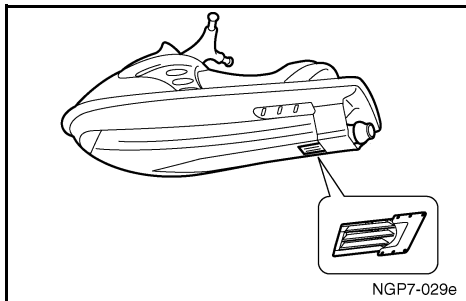

⚠ WARNING

- Keep away from intake grate while engine is on. Items such as long hair, loose clothing, or PFD straps can become entangled in moving parts resulting in severe injury or drowning.
- Stop the engine and remove the clip from the engine shut-off switch before removing any debris or weeds, which may have collected around the jet intake.

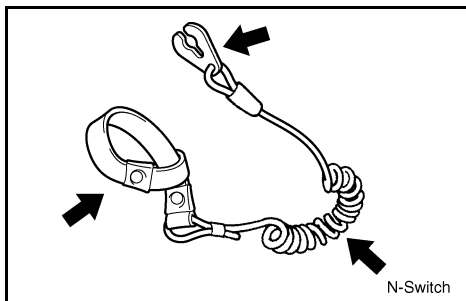

EJU10590

Engine shut-off cord (lanyard)

Check that the engine shut-off cord is not frayed or broken. If the cord is damaged, replace it; never try to repair it or tie it together.

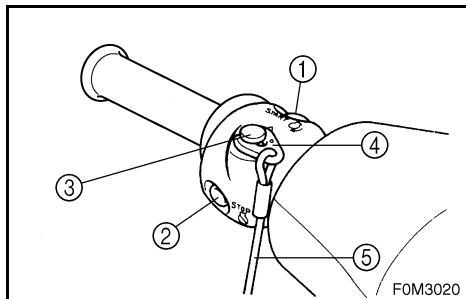

EJU18352

Switches

CAUTION:

Do not run the engine of the watercraft for more than 15 seconds on land without supplying water, otherwise the engine may overheat.

Check the start switch, the engine stop switch, and the engine shut-off switch for proper operation.

Push the start switch ① to start the engine. As soon as the engine starts running, push the engine stop switch ② to verify that the engine stops immediately. Restart the engine, and then pull the engine shut-off cord ⑤ to remove the clip ④ from the engine shut-off switch ③ to verify that the engine stops immediately. (See pages 2-9 to 2-10 for information on proper operation of the start switch, the engine stop switch, and the engine shut-off switch.)

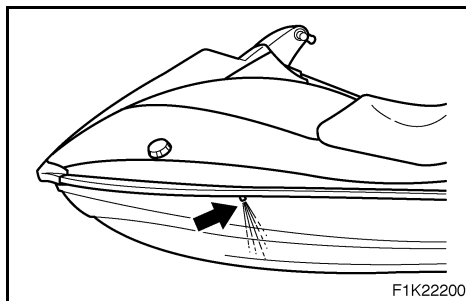

EJU13201

Cooling water pilot outlet

Check that water comes out from the pilot outlet while the engine is running and the watercraft is in the water. (See page 2-11 for more information.)

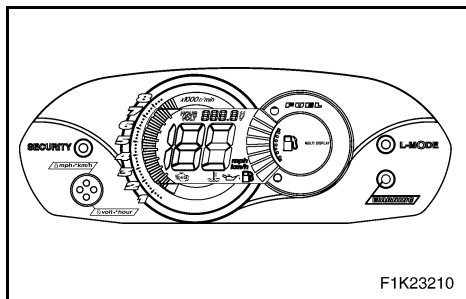

EJU12460

Multifunction meter

Check the operation of the multifunction meter. (See pages 2-15 to 2-23 for operation of the meter.)



Operation

⚠ WARNING

Before operating your watercraft, become familiar with all controls. Consult your Yamaha dealer about any control or function you do not fully understand. Failure to understand how controls work could cause an accident or prevent you from avoiding an accident.

CAUTION:

Make sure that the stern drain plugs are securely tightened before launching the watercraft.

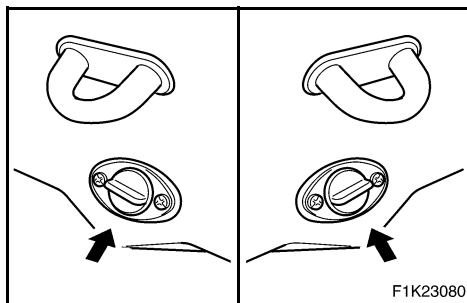

Engine break-in

The engine break-in period is essential to allow the various components of the engine to wear and polish themselves to the correct operating clearances. This ensures proper performance and promotes longer component life.

CAUTION:

Be sure to check the engine oil level before operating the watercraft for the first time. (See page 3-7 for engine oil checking procedures.)

1. Launch the watercraft and start the engine. (See page 3-17 for engine starting procedures.)



2. For the first 5 minutes, run the engine at trolling speed only. For the 30 minutes of operation after that, keep the engine speed below 5,000 r/min. For the 1 hour of operation after that, keep the engine speed below 6,500 r/min.
3. Proceed with normal operation.

CAUTION:

Failure to follow the engine break-in procedure could result in reduced engine life or even severe engine damage.

EJU21650

Launching the watercraft

When launching the watercraft, make sure that there are no obstructions around you.

If there are waves, someone should make sure that the watercraft is not pushed into the trailer after launching the watercraft.

- For VX110 Deluxe

Use the remote control transmitter to select the unlock mode. (See page 2-16 for Yamaha Security System and low-RPM mode selection procedures.)

After the watercraft is in the water, start the engine. Shift into reverse and slowly move away from the launching area.

- For VX110 Sport

After the watercraft is in the water, turn it around so the bow faces the direction you want to go. Start the engine, and then slowly move away from the launching area.



EJU20841

Starting the engine

⚠WARNING

Never start the engine or let it run for any length of time in an enclosed area. Exhaust fumes contain carbon monoxide, a colorless, odorless gas that may cause loss of consciousness and death within a short time. Always operate the watercraft in an open area.

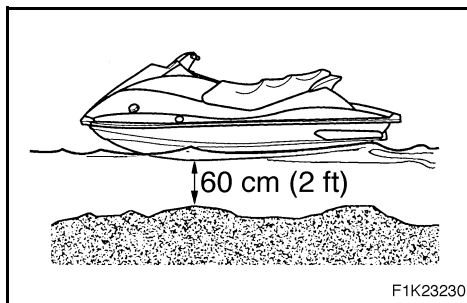

1. If the lock mode of the Yamaha Security System is selected (for VX110 Deluxe), use the remote control transmitter to select the unlock mode. (See page 2-15 for Yamaha Security System and low-RPM mode selection procedures.)
2. Launch the watercraft in water free from weeds and debris and at least 60 cm (2 ft) deep.

⚠WARNING

Never operate in water that is less than 60 cm (2 ft) deep, otherwise you increase your chance of hitting a submerged object, which could result in injury.

CAUTION:

Never operate in water that is less than 60 cm (2 ft) deep, otherwise pebbles or sand could be sucked into the jet intake, causing impeller damage or engine overheating.

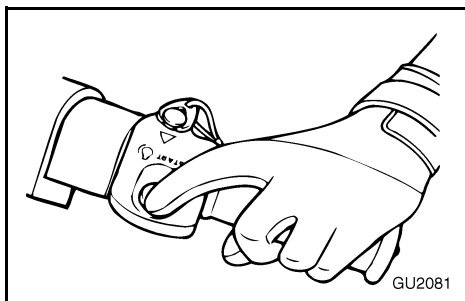
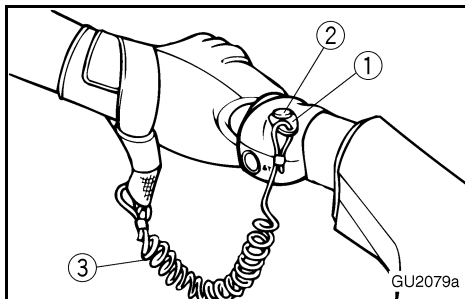

3. Attach the clip ① to the engine shut-off switch ② and attach the engine shut-off cord ③ to your left wrist.

⚠ WARNING

Check that the engine shut-off cord is not frayed or broken, and keep it free from the handlebars so the engine stops if the operator falls off. The engine shut-off cord may not pull free if wrapped around the handlebars when the operator falls off, allowing the watercraft to continue to run and cause an accident.

NOTE:

It is not possible to start the engine with the clip removed from the engine shut-off switch.

4. Push the start switch (green button), and then release it as soon as the engine starts to run.

NOTE:

The engine will not start if the throttle lever is squeezed.

CAUTION:

- Never push the start switch while the engine is running.
- Do not operate the start switch for more than 5 seconds, otherwise the battery will be discharged and the engine will not start. Also, the starter motor may be damaged. If the engine does not start in 5 seconds, release the start switch, wait 15 seconds, and then try again.

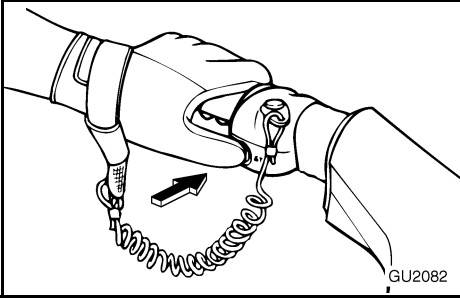

EJU10660

Stopping the engine

To stop the engine, release the throttle lever, and then push the engine stop switch (red button).

⚠WARNING

You need throttle to steer. Shutting off the engine can cause you to hit an obstacle you are attempting to avoid. A collision could result in severe injury or death.

EJU21250

Leaving the watercraft

If leaving the watercraft, select the lock mode of the Yamaha Security System (for VX110 Deluxe) and remove the engine shut-off cord to reduce the chance of accidental starting or unauthorized use by children or others. (See page 2-15 for Yamaha Security System and low-RPM mode selection procedures.)



EJU10680

Operating your watercraft

EJU12500

Getting to know your watercraft

Operating your watercraft requires skills acquired through practice over a period of time. Take the time to learn the basic techniques well before attempting more difficult maneuvers.

Operating your new watercraft can be a very enjoyable activity, providing you with hours of pleasure. However, it is essential to familiarize yourself with the operation of the watercraft to achieve the skill level necessary to enjoy riding safely. Before operating this watercraft, read this Owner's/Operator's Manual, the Riding Practice Guide, and all warning and caution labels on the watercraft. Pay particular attention to the safety information on pages 1-11 to 1-19. These materials should give you an understanding of the watercraft and its operation.

Remember: This watercraft is designed to carry the operator and up to 2 passengers. Never exceed the maximum load limit or allow more than 3 persons (or 2 persons if a water-skier is being pulled) to ride the watercraft at one time.

Maximum load: 240 kg (530 lb)
Load is the total weight of cargo,
operator and passengers.

EJU10700

Learning to operate your watercraft

Before operating the watercraft, always perform the pre-operation checks listed on page 3-5. The short time spent checking the watercraft will reward you with added safety and reliability.

Check all local laws before operating your watercraft.

Operate defensively at safe speeds and keep a safe distance away from people, objects, and other watercraft. Select a wide area to learn in, where you have good visibility and light boat traffic.

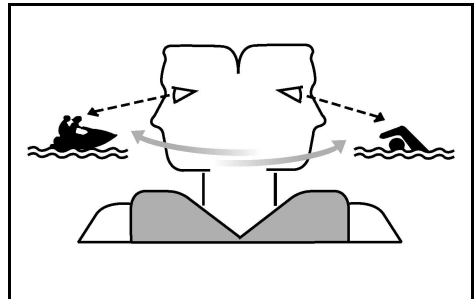

Use the buddy system—operate with someone nearby. Scan constantly for people, objects, and other watercraft. Be alert for conditions that limit your visibility or block your vision of others.

Attach the engine shut-off cord (lanyard) to your wrist and keep it free from the handlebars so that the engine stops if the operator falls off.

Wear a personal flotation device (PFD). All riders must wear an authority-approved PFD that is suitable for personal watercraft use.



Wear protective clothing. Severe internal injuries can occur if water is forced into body cavities as result of falling into the water or being near the jet thrust nozzle. Normal swimwear does not adequately protect against forceful water entry into rectum and vagina. All riders must wear a wetsuit bottom or clothing that provides equivalent protection.

Such clothing includes thick, tightly woven, sturdy and snug-fitting apparel such as denim, but does not include spandex or similar fabrics like those used in bicycle shorts. A full wetsuit can also protect against hypothermia (subnormal body temperature) and abrasions.

Footwear and gloves are recommended.

Eye protection is recommended to keep wind, water, and glare from the sun out of your eyes while you operate your watercraft. Restraining straps for eyewear are made which are designed to float should your eyewear fall in the water.

You should grip the handlebars firmly and keep both feet on the floor of the footwell. Do not attempt to ride with passengers until your operating skills are fully developed.

EJU18653

Riding watercraft with passengers

When 2 or 3 persons (including the operator) are on board, the watercraft handles differently, and is not as easy to maneuver, so operating it requires a higher degree of skill. Before attempting to operate the watercraft with passengers on board, the operator must practice operating the watercraft alone enough to be able to acquire the necessary skills.

The passengers must always wear an authority-approved PFD and a wetsuit bottom or equivalent.

⚠WARNING

Do not apply throttle when anyone is at rear of watercraft. Turn engine off or keep engine at idle. Water and/or debris exiting the jet thrust nozzle can cause severe injury. Passengers should not attempt to board the watercraft if the operator is applying throttle.

Do not give a ride to children whose feet cannot reach the floor of the footwell. The passengers should hold on firmly, either to the person in front of them or to the handgrip provided, and keep both feet on the floor of footwell.

⚠WARNING

When passengers are on board, make sure that they are holding on firmly and have feet in the footwell before you start to accelerate.

When pulling a skier, the spotter should face to the rear while holding the handgrip with both hands. The spotter should always sit astride the seat with his or her feet placed firmly on the floor of the footwell for proper balance. Follow all local laws regarding skiing such as skier-down flags, rearward-facing spotter, and other requirements.



EJU18370

Starting the watercraft

⚠ WARNING

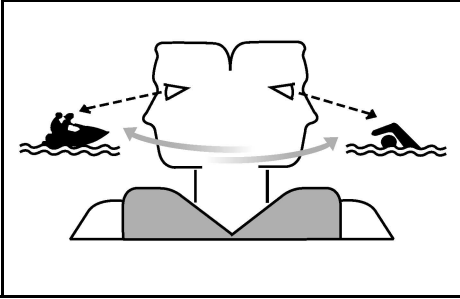

- Scan constantly for people, objects, and other watercraft. Be alert for conditions that limit your visibility or block your vision of others.
- Operate defensively at safe speeds and keep a safe distance away from people, objects, and other watercraft.
- Do not follow directly behind watercraft or other boats. Do not go near others to spray or splash them with water. Avoid sharp turns or other maneuvers that make it hard for others to avoid you or understand where you are going. Avoid areas with submerged objects or shallow water.
- Take early action to avoid collisions. Remember watercraft and other boats do not have brakes. Do not release the throttle when trying to steer away from objects—you need throttle to steer.
- Practice reboarding in shallow water before riding in deep water.

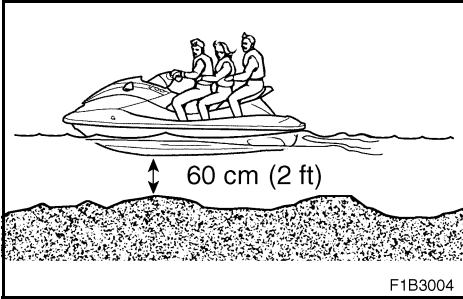

EJU10730

Starting and boarding in shallow water

1. Do not start the engine in less than 60 cm (2 ft) of water. Put the watercraft in water that is deep enough, and then board the watercraft from the side or the rear.
2. Attach the engine shut-off cord to your left wrist, and then install the clip to the engine shut-off switch.
3. Grip the handlebars with both hands, place both feet on the floor of the foot-well, start the engine, and start off.

EJU10740

Starting from a dock

1. Board the watercraft from the side.
2. Attach the engine shut-off cord to your left wrist, and then install the clip to the engine shut-off switch.
3. Push the watercraft away from the dock, grip the handlebars with both hands, place both feet on the floor of the foot-well, start the engine, and start off.



EJU10750

Boarding and starting in deep water

⚠WARNING

- Operator and passenger should practice getting on board in shallow water before riding in deep water. Boarding in deep water requires more skill.
- The fatigue and exposure that could result after unsuccessful attempts to get back on the watercraft may increase the risk of injuries and drowning.

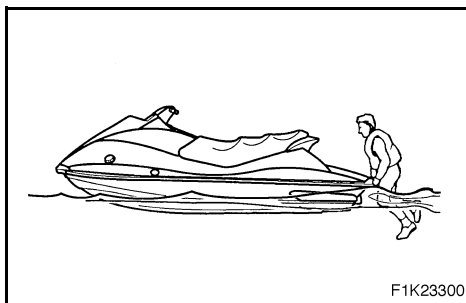

F1K23300

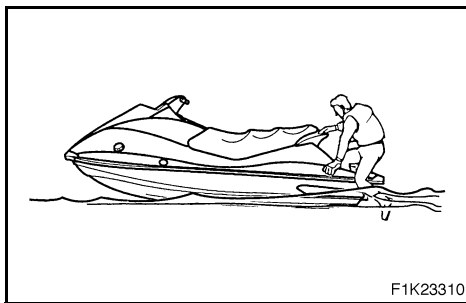

F1K23310

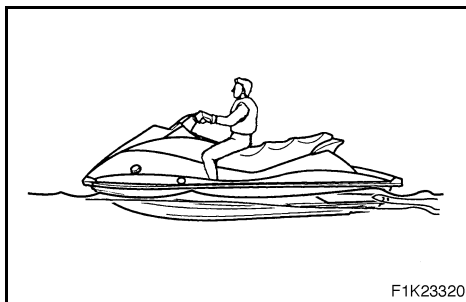

F1K23320

EJU18380

Boarding alone

1. Swim to the rear of the watercraft and place both hands on the boarding platform, pull yourself up, and then grasp the handgrip with one hand.
2. Pull yourself up to a kneeling position on the platform, and then move to the seat and sit astride.
3. Attach the engine shut-off cord to your left wrist, and then install the clip to the engine shut-off switch.
4. Grip the handlebars firmly with both hands, place both feet on the floor of the footwell, start the engine, and then look in all directions before starting off.

⚠WARNING

Before starting off, make sure that there are no boats, obstructions, or swimmers around you.



EJU21130

Boarding with passengers

⚠WARNING

Severe internal injuries can occur if water is forced into body cavities as a result of being near the jet thrust nozzle. Do not apply throttle until the passengers are seated with their feet on the floor of the footwell and are securely holding on to the person in front of them or to the handgrip provided.

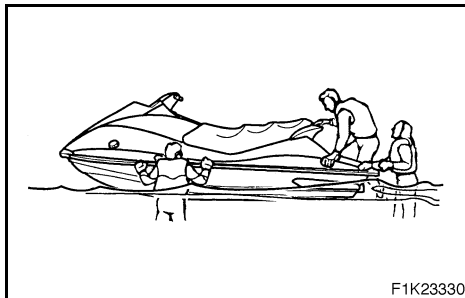

F1K23330

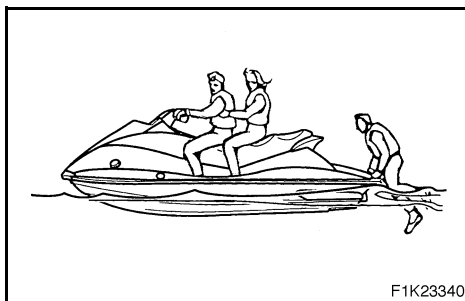

F1K23340

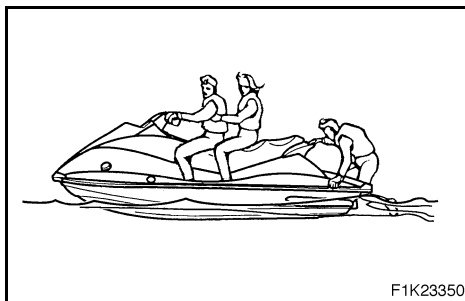

F1K23350

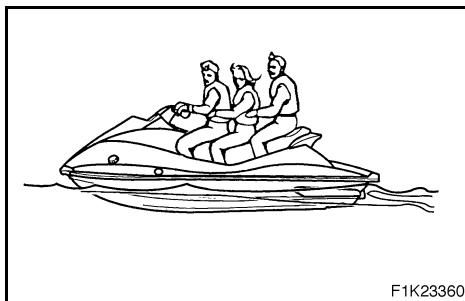

F1K23360

1. Climb on board as noted in the previous section, and sit astride the seat. Attach the engine shut-off cord to your left wrist, and then install the clip to the engine shut-off switch.
2. Have the passenger move to the rear of the watercraft.
3. Have the passenger get on board and sit on the seat. If a second passenger is getting on, have him or her follow the same procedure.

NOTE:

When a passenger is getting on board, both he and the operator should try to balance the watercraft.

4. The operator should check to see that the passengers have their feet on the floor of the footwell and that they are securely holding on to the person in front of them or to the handgrip provided.
5. Start the engine, look in all directions, and then accelerate to planing speed.

⚠WARNING

Before starting off, make sure that there are no boats, obstructions, or swimmers around you.

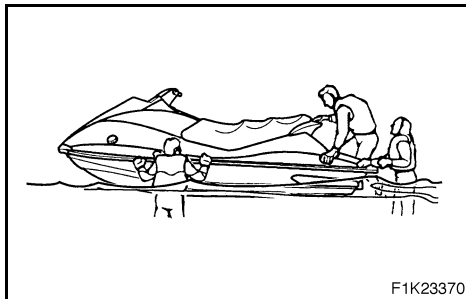

F1K23370

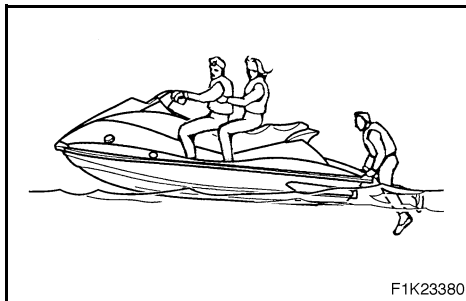

F1K23380

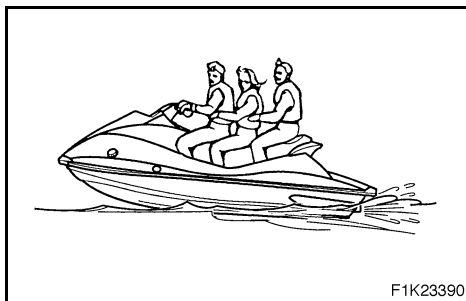

F1K23390

NOTE:

The heavier the total weight of the operator and passengers, the more difficult it will be to balance the watercraft. Do not operate the watercraft when the total weight exceeds 240 kg (530 lb) including any cargo. If it is difficult to balance the watercraft at a standstill, proceed as follows:

1. The passenger must steady the watercraft while the operator is boarding. The operator pulls him or herself up to a kneeling position on the platform, and then moves to the seat and sits astride to balance the watercraft.
2. The operator attaches the engine shut-off cord to his or her left wrist, and then installs the clip to the engine shut-off switch.
3. The operator starts the engine and lets it run at idle.
4. The passenger pulls him or herself up to a kneeling position, and then crawls onto the seat as the watercraft accelerates.
5. The operator gradually increases speed to balance the watercraft.



EJU18102

Capsized watercraft

If the watercraft capsizes, turn it over immediately.

Be sure to carefully follow the procedures below to prevent injury or damage to the watercraft.

⚠ WARNING

IMPROPER UPRIGHTING CAN CAUSE INJURY:

- Make sure that the engine shut-off cord is removed from the engine shut-off switch.
- Do not put your hands in the intake grate.
- Watch so you are not hit by the watercraft as it comes over.

CAUTION:

If the watercraft capsizes, release the throttle lever immediately. Oil could flow into the air filter case and the engine could be damaged.

1. Remove the clip from the engine shut-off switch.
2. Swim to the rear of the watercraft. Pull the watercraft over with your left hand on the ride plate while pushing down on the gunwale with your right hand or foot.

NOTE:

If the port (left) side of the capsized watercraft is tilting up, push down on the gunwale so that the port (left) side is down before turning the watercraft clockwise.

CAUTION:

Do not turn the watercraft over counter-clockwise, otherwise water can leak into the engine, which can result in severe damage.

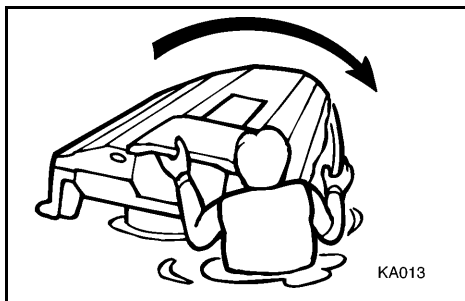

KA013

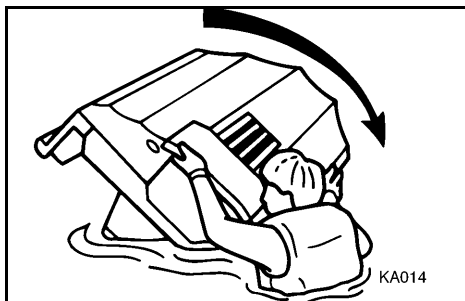

KA014



3. Start the engine and operate the watercraft to discharge any water remaining in the engine compartment. (If the engine does not start, see page 5-7, "Towing the watercraft" or page 5-8, "Submerged watercraft.")

CAUTION: _____

Do not operate the engine at full throttle for at least one minute after the engine has been restarted. Excessive water in the bilge can splash into the engine, which can result in severe damage.

NOTE: _____

To efficiently discharge water from the engine compartment, operate the watercraft as straight as possible and above planing speed for at least 2 minutes.



EJU19960

Turning the watercraft

Steering control depends on the combination of handlebar position and the amount of throttle.

Water sucked in through the intake grate is pressurized by the impeller in the jet pump. As the pressurized water is expelled from the pump through the jet thrust nozzle, it creates thrust to move and steer the watercraft. The higher the engine speed, the more thrust produced.

The amount of jet thrust, in addition to the position of the handlebars, determines how sharply you turn.

- A. More throttle produces higher thrust, so the watercraft will turn more sharply.
- B. Less throttle produces lower thrust, so the watercraft will turn more gradually.
- C. Releasing the throttle lever completely produces only minimum thrust. If you are traveling at speeds above trolling, you will have rapidly decreasing ability to steer without throttle. You may still have some turning ability immediately after releasing the throttle lever, but once the engine slows down, the watercraft will no longer respond to handlebar input until you apply throttle again or you reach trolling speed.

At trolling speed, the watercraft can be turned gradually by handlebar position alone using just the amount of thrust available at idle.

- D. If the engine is stopped while riding, there is no thrust. The watercraft will go straight even though the handlebars are turned.

You need throttle to steer.

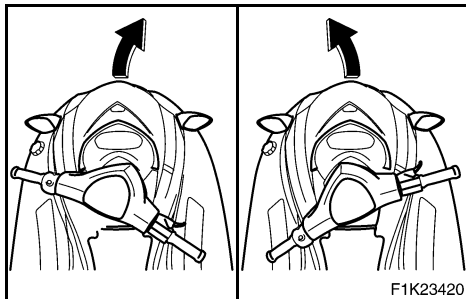

F1K23420

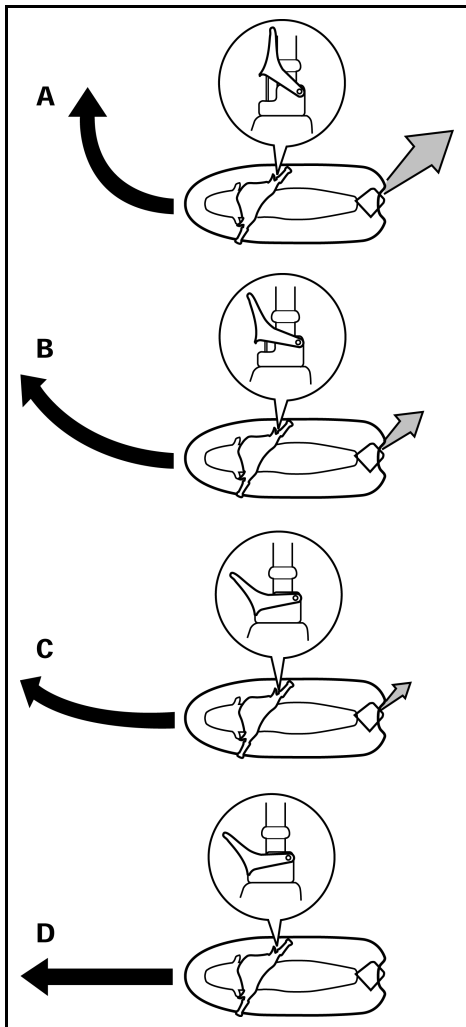

**⚠ WARNING**

- **Do not release the throttle lever when trying to steer away from objects—you need throttle to steer. A collision could result in severe injury or death.**
- **When operating at higher speeds, make gradual turns or slow down before turning. Sharp high-speed turns may cause the watercraft to slide sideways or spin, throwing the operator and passengers overboard which could cause an injury.**

This model has the Yamaha Engine Management System (YEMS) that includes an Off-Throttle Steering (OTS) system. It will activate at planing speeds should you attempt to steer the watercraft after releasing the throttle lever (see condition C above). The OTS system assists in turning by continuing to supply some thrust while the watercraft is decelerating, but you can turn more sharply if you apply throttle while turning the handlebars. The OTS system does not function below planing speeds or when the engine is off. Once the engine slows down, the watercraft will no longer turn in response to handlebar input until you apply throttle again or you reach trolling speed.



EJU18501

Stopping the watercraft

The watercraft is not equipped with a separate braking system. It is stopped by water resistance when the throttle lever is released. From full speed, the watercraft comes to a complete stop in approximately 100 m (330 ft) after the throttle is released or the engine is stopped, although this distance will vary depending on many factors, including gross weight, water surface conditions, and wind direction. The watercraft slows down as soon as the throttle lever is released, but will coast for a distance before fully stopping. If you are not sure you can stop in time before hitting an obstacle, apply throttle and turn in another direction.

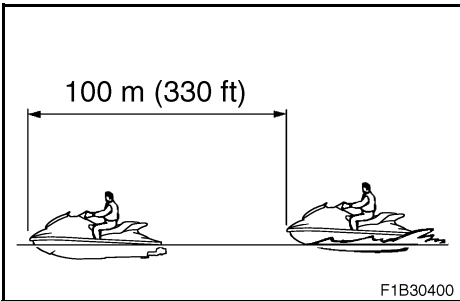

⚠ WARNING

- **Allow adequate stopping distance.**
- **Take early action to avoid collisions. Remember, watercraft and other boats do not have brakes.**
- **Operate defensively at safe speeds and keep a safe distance away from people, objects, and other watercraft to give you time to stop.**
- **Do not shut the engine off when slowing down in case you need engine power to steer away from a boat or other obstacle that comes into your path.**
- **For VX110 Deluxe:**
Do not use the reverse function to slow down or stop the watercraft as it could cause you to lose control, be ejected, or impact the handlebars.



EJU10810

Beaching the watercraft

1. Make sure no obstructions, boats or swimmers are near the beach. Release the throttle lever about 100 m (330 ft) before you reach the intended beaching area.
2. Approach the beach slowly and stop the engine before reaching land.
Remember: you need throttle to steer.
3. Get off the watercraft and pull it up on the beach.

CAUTION:

Small pebbles, sand, seaweed, and other debris can be pulled into the jet intake and impair or damage the impeller. Always stop the engine and get off before beaching the watercraft.

EJU10820

Docking the watercraft

1. Make sure that no obstructions, boats or swimmers are close to the watercraft. Reduce speed about 100 m (330 ft) away from the dock.
2. Slowly approach the dock and stop the engine just before coming alongside it.

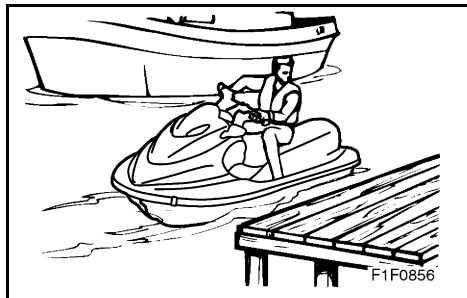

EJU12541

Reverse on waterways (for VX110 Deluxe)

Reverse can be used for slow-speed maneuvering when it is necessary to back up out of tight spots where you cannot turn around. Reverse can only be used to slow down or stop during slow-speed maneuvering, such as when docking.

Once the engine is idling, shift into reverse and gradually increase engine speed. Make sure that there are no obstacles or people behind you before shifting into reverse.

EJU12550

Rough water operation

The force of landing after jumping can cause a strong impact on both the watercraft and the operator and passengers. It is possible for the operator to hit his or her chest or jaw on the watercraft body or handlebars and be injured. Do not operate the watercraft with your chin right above the handlebars or with your feet outside the watercraft. Operating in rough water or jumping waves can also crack the watercraft body or damage internal parts. Avoid operating in rough water or bad weather conditions.



EJU10841

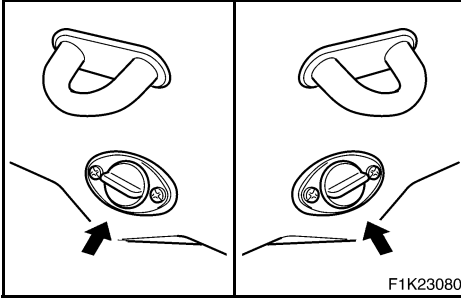

Post-operation checks

Always perform the following post-operation checks after operating the watercraft.

1. Remove the watercraft from the water.
2. Wash down the hull, handlebars, and jet unit with fresh water.
3. Remove the seat and check the engine compartment for water. To drain excess water, remove the stern drain plugs, and then raise the bow of the watercraft enough to allow water in the bilge to drain out.

NOTE: _____

This watercraft is equipped with an automatic bilge-draining system that removes water from the engine compartment while you are underway. However, some residual water will remain.

4. Put the watercraft in a horizontal position.
5. Flush the cooling system to prevent it from clogging with salt, sand, or dirt. (See page 4-1 for flushing procedures.)
6. Drain residual water from the exhaust system by alternately squeezing and releasing the throttle lever for 10 to 15 seconds while the engine is running.

CAUTION: _____

Do not run the engine for more than 15 seconds on land. The engine could overheat.



7. If the watercraft will be stored for a week or more, lubricate internal engine components to help prevent corrosion. (See page 4-3 for lubrication procedures.)
8. Rinse the engine and engine compartment with a small amount of water.

CAUTION:

Do not use high pressure when rinsing the engine or engine compartment as severe engine damage could result.

9. Wipe the engine and engine compartment dry with a clean cloth (repeat step 3, if necessary).
10. Wipe the hull, handlebars, and jet unit dry with a clean cloth.
11. Spray a rust inhibitor on metallic parts to minimize corrosion.
12. Allow the engine compartment to air dry completely before reinstalling the seat.



EJU18111

Transporting

When transporting the watercraft on a trailer, secure the tie downs to the trailer through the bow eye and stern eye.

CAUTION:

- Do not route ropes or tie downs over the seat, as they may leave permanent marks on the seat's surface. Also, wrap the ropes or tie downs with towels or rags where they touch the body of the watercraft to avoid scratches or damage.
- For VX110 Deluxe:
Before putting the watercraft on the trailer or transporting it, be sure to put the shift lever in the forward position, otherwise the reverse gate may hit an obstruction, which may cause damage.

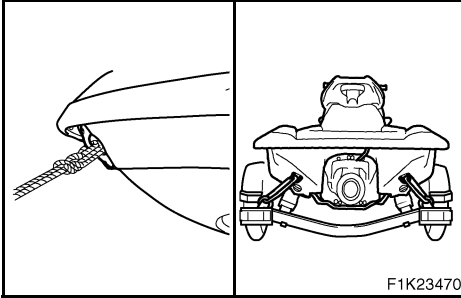



-MEMO-

EJU10860

MAINTENANCE AND CARE



Storage	4-1
Flushing the cooling system	4-1
Lubrication	4-3
Fuel system	4-4
Battery	4-5
Cleaning the watercraft	4-6
Maintenance and adjustments	4-7
Owner's/Operator's Manual and tool kit	4-8
Periodic maintenance chart	4-9
Inspecting the fuel system	4-10
Changing the engine oil	4-11
Checking the air filter element	4-13
Inspecting the jet thrust nozzle angle	4-13
Inspecting the shift cable (for VX110 Deluxe)	4-13
Inspecting and adjusting the throttle cable	4-14
Cleaning and adjusting the spark plugs	4-15
Lubrication points	4-17
Inspecting the battery	4-19
Adjusting the fuel injection system	4-21
Replacing the fuses	4-22
Specifications	4-23



Storage

⚠ WARNING

Always place the watercraft upright in a horizontal position when storing it, otherwise fuel could leak out into the engine or engine compartment, which could result in a fire hazard.

Storage for prolonged periods of time, such as winter storage, requires preventative maintenance to ensure against deterioration. It is advisable to have the watercraft serviced by a Yamaha dealer prior to storage. However, the following procedures can be performed by the owner.

EJU21260

Flushing the cooling system

Flushing the cooling system is essential to prevent the cooling system from being clogged with salt, sand, or dirt.

CAUTION:

- **Do not supply water to the cooling water passages when the engine is not running. The water could flow back through the muffler into the crankcase causing severe engine damage.**
- **Do not run the engine of the watercraft for more than 15 seconds without supplying water, otherwise the engine may overheat.**

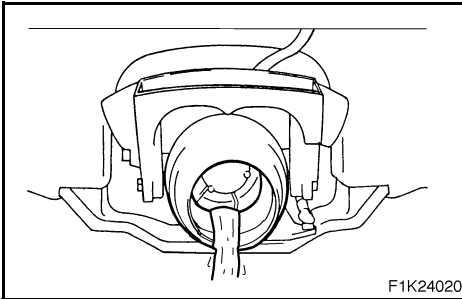
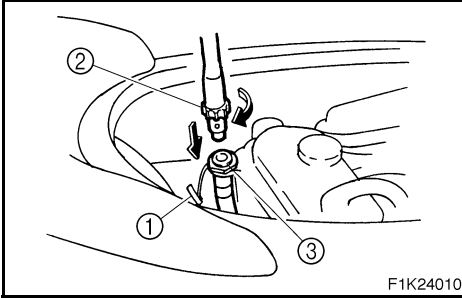

1. Put the watercraft on land in a horizontal position.
2. Remove the seat. (See page 2-5 for seat removal and installation procedures.)
3. Remove the flushing hose connector cap ①, and then insert the garden hose adapter ② into the flushing hose connector ③ and turn it until it is securely connected.
4. Connect the garden hose adapter to a water tap using a hose.
5. Start the engine, and then immediately turn the water supply on until water flows out continually from the jet nozzle.
6. Run the engine at idling speed for about 3 minutes watching the engine condition. If the engine stops while flushing, turn the water supply off immediately and repeat the above steps.
7. Turn the water supply off, and then force the remaining water out from the cooling passages by alternately squeezing and releasing the throttle lever for 10 to 15 seconds.
8. Stop the engine.
9. Remove the garden hose adapter and install the cap.



EJU21270

Lubrication

⚠WARNING

Do not spray flammable rust inhibitor products on engine surfaces while the engine is hot. The sprayed substance or propellants could catch fire.

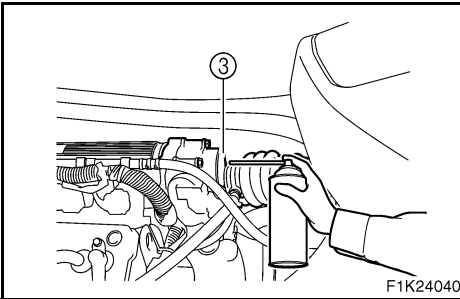
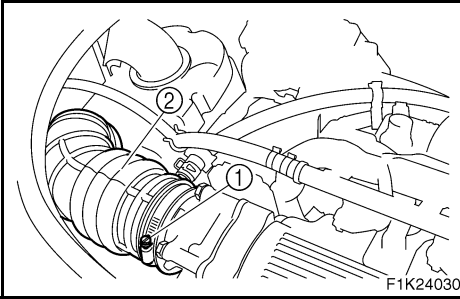

1. Remove the seat. (See page 2-5 for seat removal and installation procedures.)
2. Loosen the clamp screw ① and disconnect the air intake duct ②.
3. Spray a rust inhibitor into the intake opening ③ for 3 seconds.
4. Connect the air intake duct and tighten the clamp screw.
5. Start the engine in a well-ventilated area and let it run at idle for 15 seconds.

CAUTION:

Do not run the engine for more than 15 seconds. The engine could overheat.

6. Lubricate all cables such as the throttle and steering cables.

NOTE:

Use a suitable marine grease applicator to pressure lubricate the cables and purge out any moisture between the inner and outer cables.

7. Lubricate the areas of the watercraft specified under Lubrication points on page 4-17.



EJU19652

Fuel system

⚠WARNING

GASOLINE AND ITS VAPORS ARE HIGHLY FLAMMABLE AND EXPLOSIVE!

- Do not smoke when refueling, and keep away from sparks, flames, or other sources of ignition.
- Stop engine before refueling.
- Refuel in a well-ventilated area with the watercraft in a horizontal position.
- Do not stand or sit on the watercraft while refueling in case of fire.
- Take care not to spill gasoline. If gasoline spills, wipe it up immediately with dry rags. Always properly dispose of gasoline-soaked rags.
- Avoid overfilling the fuel tank. Stop filling when the fuel level reaches approximately 50 mm (2 in) from the top of the fuel tank. Fuel expands as it warms up and could overflow if the fuel tank has been overfilled. If temporarily leaving the watercraft with a full fuel tank, do not leave it in direct sunlight. Leave it in a well-ventilated area with the watercraft in a horizontal position.
- Tighten the filler cap securely after refueling.
- If you should swallow some gasoline, inhale a lot of gasoline vapor, or get gasoline in your eyes, get immediate medical attention.
- If any gasoline spills onto your skin, immediately wash with soap and water. Change clothing if gasoline spills on it.

Top off the fuel tank with fresh gasoline and add fuel stabilizer and conditioner to the fuel tank by following the manufacturer's instructions carefully.



EJU19700

Battery

If the watercraft will not be used for more than a month, disconnect the negative (-) lead first, then the positive (+) lead and breather hose, and then remove the battery from the watercraft.

Clean the battery casing using fresh water.

If the battery terminals are dirty or corroded, clean them with a wire brush.

Fully charge the battery, and then store it in a cool, dark place.

Apply Yamaha marine grease or Yamaha grease A to the battery terminals.

Check the battery at least every 2 months and fully charge it if necessary.

⚠WARNING

Be sure to connect the breather hose to the battery. Fire or explosion could result if the breather hose is damaged, obstructed, or not connected properly.

CAUTION:

The battery may not be usable again if you store it for a long period without charging it. Charge the battery periodically.

**NOTE:** _____

The condition of the battery can be known by checking the specific gravity of the electrolyte. However, you can also know the condition of the battery by measuring the voltage at both battery terminals. Charge the battery if the voltage is less than 12 volts.

Specific gravity (for reference): 1.28 at 20 °C (68 °F)
--

It is recommended to have a Yamaha dealer check the specific gravity and to charge the battery. If you maintain the battery yourself, be sure to read and follow the instructions provided with the battery tester and charger you use.

EJU10930

Cleaning the watercraft

Clean the watercraft before storing it for a long period.

1. Wash down the hull, handlebars, and drive unit with fresh water.
2. Rinse the engine and bilge area with fresh water. Drain off all water and wipe up remaining moisture with clean, dry rags.
3. Spray the engine's exterior with a rust inhibitor and lubricant.
4. Wax the hull with a non-abrasive wax.
5. Wipe all vinyl and rubber components, such as the seat and engine compartment seals, with a vinyl protectant.



Maintenance and adjustments

Periodic inspection, adjustment and lubrication will keep your watercraft in the safest and most efficient condition possible. Safety is an obligation of the watercraft owner. The most important points of watercraft inspection, adjustment and lubrication are explained on the following pages.

See your Yamaha dealer for genuine Yamaha replacement parts and optional accessories designed for your watercraft.

Remember that failures that are the result of the installation of parts or accessories which are not qualitatively equivalent to genuine Yamaha parts are not covered by the limited warranty.

⚠ WARNING

- **Be sure to turn off the engine when you perform maintenance unless otherwise specified, otherwise an accident or injury could result from unexpected operation, moving parts, or electric shock. If the owner is not familiar with watercraft servicing, this work should be done by a Yamaha dealer. Improperly serviced components could fail or stop operating correctly, which could result in an accident.**
- **Modifications to this watercraft not approved by Yamaha may cause loss of performance or excessive noise, or render it unsafe for use. Consult a Yamaha dealer before attempting any changes.**

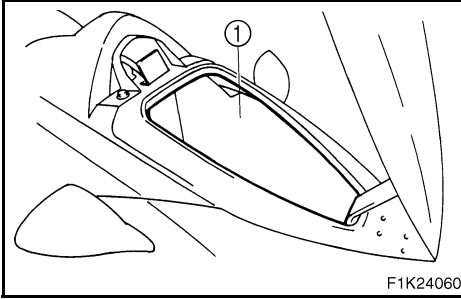

EJU18750

Owner's/Operator's Manual and tool kit

It is advisable always to carry the Owner's/Operator's Manual and tool kit ② with you whenever you use the watercraft. For your convenience, a storage compartment ① is provided on the watercraft for the manual and tool kit.

NOTE:

To protect these materials from water damage, it would be a good idea to put them in a waterproof bag.

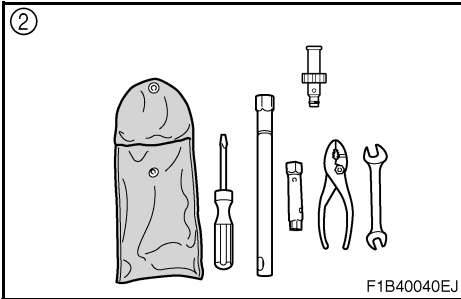

The service information included in this manual is intended to provide you with the necessary information for completing your own preventive maintenance and minor repairs. The tools provided in the tool kit are sufficient for this purpose.



EJU13550

Periodic maintenance chart

The following chart gives general guidelines for periodic maintenance. However, depending on your operating conditions maintenance may need to be performed more frequently.

● This mark indicates maintenance that you may do yourself.

○ This mark indicates work to be done by a Yamaha dealer.

MAINTENANCE INTERVAL		INITIAL			THEREAFTER EVERY		PAGE
		10 hours	50 hours	100 hours	100 hours	200 hours	
			6 months	12 months	12 months	24 months	
ITEM							
Spark plug	Inspect, clean, adjust	●		●	●		4-15
Lubrication points	Lubricate			●	●		4-17
Fuel system	Inspect			○	○		4-10
Fuel tank	Inspect, clean			○	○		4-10
Trolling speed	Inspect			○	○		4-21
Throttle shaft	Inspect			○	○		—
Cooling water passages	Flush	●*1					4-1
Water inlet strainer	Inspect, clean			○	○		—
Bilge strainer	Clean			○	○		—
Impeller	Inspect			○	○		—
Jet thrust nozzle angle	Inspect, adjust			●/○	●/○		4-13
Shift cable and mechanism (VX110 Deluxe)	Inspect, adjust			○	○		4-13
Throttle cable	Inspect, adjust	○		○	○		4-14
Stern drain plugs	Inspect, replace			○	○		3-9
Battery	Inspect			○	○		4-19
Rubber coupling	Inspect					○	—
Engine mount	Inspect					○	—
Nuts and bolts	Inspect	○		○	○		—
Air filter	Inspect, replace			○	○		4-13
Engine oil	Replace	○		○	○		4-11
Engine oil filter	Replace			○	○		—
Valve clearance	Inspect, adjust					○	—

*1: After every use



EJU18160

Inspecting the fuel system

⚠WARNING

Gasoline is highly flammable and explosive. Failure to check for and repair any fuel leakage could result in fire or explosion. A fire or explosion can cause severe injury or death. Shut off the engine. Do not smoke. Avoid spilling gasoline.

Fuel in hose is pressurized.

Fuel can spray out and cause injury or a fire hazard if fuel line is disconnected.

Do not attempt to run engine with fuel line disconnected.

Check the fuel system for leaks, cracks, or malfunctions. If any problem is found, consult a Yamaha dealer.

Check:

- Fuel tank for water or dirt.
- Fuel tank cap (seal) for damage.
- Fuel tank for damage, cracks or leakage.
- Fuel hose joint for leakage.
- Fuel hose for cracks or other damage.
- Air bleeding passages for leakage.

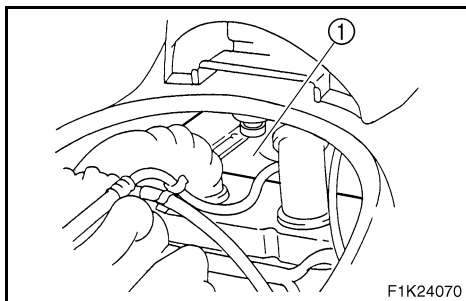

EJU18410

Fuel tank

Check the fuel tank ① for leakage or water in the tank. If water is found in the fuel system or if the fuel tank needs to be cleaned, have a Yamaha dealer service the watercraft.



EJU21590

Changing the engine oil

⚠ WARNING

Engine oil is extremely hot immediately after the engine is turned off. Coming into contact with or getting any engine oil on your clothes could result in burns.

CAUTION:

- Do not run the engine with too much or not enough oil in the oil tank. Oil could spray out and the engine could be damaged.
- Be sure to change the engine oil after the first 10 hours of operation, and every 100 hours thereafter or at the start of a new season, otherwise the engine will wear quickly.

The oil filter should be replaced every year or every 100 hours of operation. Have a Yamaha dealer replace the oil filter if necessary.

It is recommended to have a Yamaha dealer change the engine oil. However, if you choose to change the oil on your own, consult a Yamaha dealer.

NOTE:

Dispose of used oil according to local regulations.

Recommended engine oil:

See page 3-3.

Oil quantity:

With oil filter replacement:

2.2 L (2.3 US qt, 1.9 Imp qt)

Without oil filter replacement:

2.0 L (2.1 US qt, 1.8 Imp qt)

Total amount:

4.3 L (4.5 US qt, 3.8 Imp qt)

**CAUTION:**

If oil is leaking or the oil pressure warning indicator comes on when the engine is running, immediately turn the engine off and have a Yamaha dealer check the watercraft. Continuing to operate the engine under such conditions could cause severe engine damage.



EJU21280

Checking the air filter element

Have a Yamaha dealer check and clean or replace the air filter element every 12 months or every 100 hours of operation.

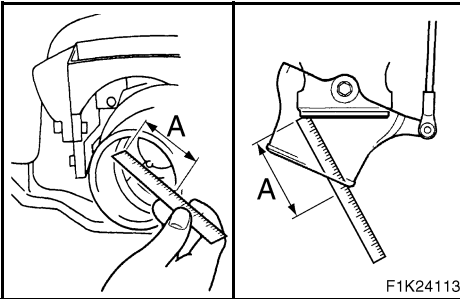

EJU18891

Inspecting the jet thrust nozzle angle

Check for smooth operation of the handlebars and jet thrust nozzle.

Turn the handlebars as far as possible to the right and left and check that the difference of distances A and B between the jet thrust nozzle and the nozzle is within specification.

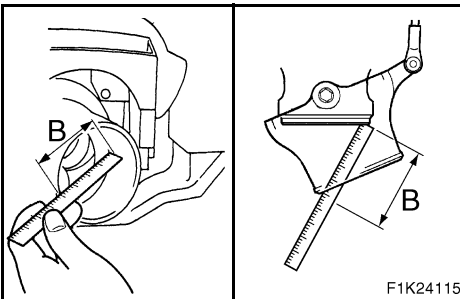

Difference of A and B:
Maximum 5 mm (0.20 in)

If steering is stiff or misadjusted, have a Yamaha dealer service it.

EJU21290

Inspecting the shift cable (for VX110 Deluxe)

Place the shift lever in the reverse position.

Make sure that the reverse gate makes contact with the stopper ①.

If the reverse gate does not make contact with the stopper, have a Yamaha dealer service it.

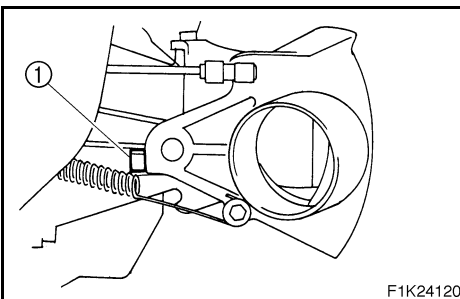

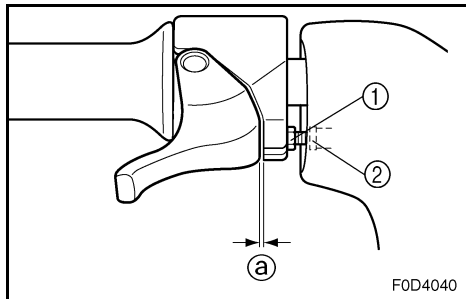

EJU11040

Inspecting and adjusting the throttle cable

Check that the throttle cable moves back to the set position smoothly and that free play is within specification.

1. Squeeze and release the throttle lever. If the lever does not return smoothly, have a Yamaha dealer service it.
2. Adjust free play **a** by loosening the lock-nut **1** and turning the adjuster **2**.

Throttle lever free play:
4–7 mm (0.16–0.28 in)



EJU21300

Cleaning and adjusting the spark plugs

The spark plug is an important engine component and is easy to inspect. The condition of the spark plug can indicate something about the condition of the engine. For example, if one spark plug shows a distinctly different color, the engine could be defective. Do not attempt to diagnose any problems yourself. Have a Yamaha dealer service the watercraft.

Remove and inspect the spark plugs periodically; heat and deposits will cause the spark plugs to slowly break down and erode. If electrode erosion becomes excessive, or if carbon and other deposits are excessive, replace the spark plug with the specified plug.

Specified spark plug: NGK CR9EB

To remove a spark plug:

1. Remove the seat. (See page 2-5 for seat removal and installation procedures.)
2. Remove the spark plug cap.

CAUTION:

Do not use any tools to remove or install the spark plug cap, otherwise the ignition coil coupler may be damaged. The spark plug cap may be difficult to remove because the rubber seal on the end of the cap fits tightly. To remove the spark plug cap, simply twist it back and forth while pulling it up; to install it, twist it back and forth while pushing it down.

3. Remove the spark plug.

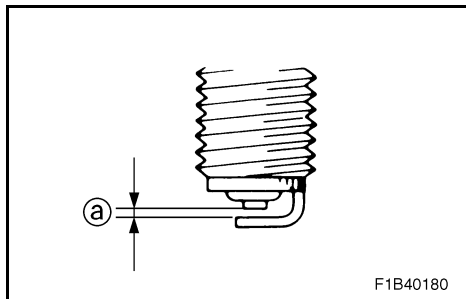

Measure the spark plug gap ① with a wire thickness gauge. Replace the spark plug or adjust the gap to specification if necessary.

Spark plug gap:
0.7–0.8 mm (0.028–0.031 in)

To install a spark plug:

1. Clean the gasket surface.
2. Wipe any dirt from the threads of the spark plug.
3. Install the spark plug, and then tighten it to specification.

Spark plug tightening torque:
12.5 N·m (1.25 kgf·m, 9 ft·lb)

4. Install the spark plug cap.

NOTE:

- Wipe off any water on the spark plug or inside the spark plug cap before installing the cap. Push the spark plug cap down until it is securely installed.
- If a torque wrench is not available when you are installing a new spark plug, a good estimate of the correct torque is 1/4 turn to 1/2 turn past finger tight with the spark plug wrench included in the tool kit. Have the spark plug adjusted to the correct torque with a torque wrench as soon as possible.

⚠WARNING

Be careful not to damage the insulator when removing or installing a spark plug. A damaged insulator could allow sparks to escape, which could lead to an explosion or fire.



EJU21310

Lubrication points

To keep moving parts sliding or rotating smoothly, coat them with water-resistant grease.

Recommended water-resistant grease:
Yamaha Marine Grease/
Yamaha Grease A

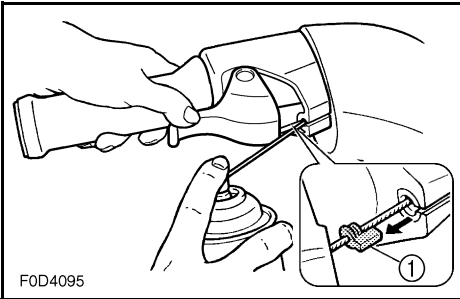

- Throttle cable (handlebar end)
Pull the throttle lever and remove the seal ①. Spray a rust inhibitor into the outer cable. Refit the seal securely.

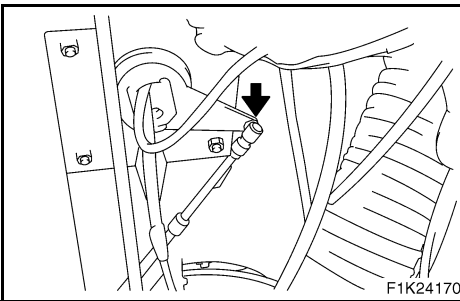

- Steering cable (handlebar end)

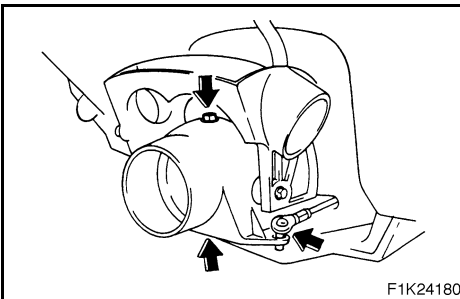

- Steering cable (nozzle end)
- Nozzle pivot shaft

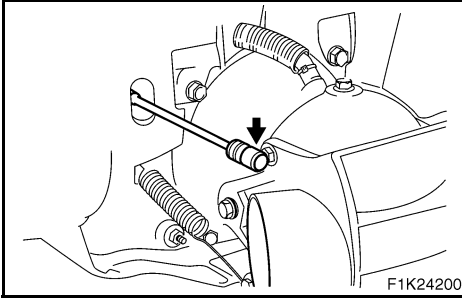

For VX110 Deluxe:

- Shift cable (reverse gate end)



EJU19710

Inspecting the battery

Check the level of the battery electrolyte and make sure that the negative and positive leads are securely tightened.

⚠ WARNING

- **Battery electrolyte is poisonous and dangerous, causing severe burns, etc. Electrolyte contains sulfuric acid. Avoid contact with skin, eyes, or clothing.**

Antidotes

External: Flush with water.

Internal: Drink large quantities of water or milk. Follow with milk of magnesia, beaten egg, or vegetable oil. Call physician immediately.

Eyes: Flush with water for 15 minutes and get prompt medical attention.

Batteries produce explosive gases. Keep sparks, flame, cigarettes, etc., well away. If using or charging the battery in an enclosed space, make sure that it is well ventilated. Always shield your eyes when working near batteries.

KEEP OUT OF THE REACH OF CHILDREN.

- **Be sure to connect the breather hose to the battery. Fire or explosion could result if the breather hose is damaged, obstructed, or not connected properly.**

CAUTION:

- **Be careful not to place the battery on its side.**
- **Be sure to remove the battery from the battery compartment when adding electrolyte or charging the battery.**

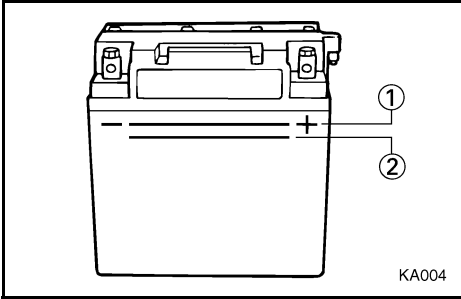
**To replenish the battery:**

1. Make sure that the electrolyte level is between the upper ① and lower ② level marks.
2. Refill the battery with distilled water if necessary.

CAUTION:

Normal tap water contains minerals that are harmful to a battery. Use only distilled water for replenishing the battery.

To recharge the battery:**CAUTION:**

Do not attempt to charge a battery hastily. Battery life could be shortened.

It is recommended to have a Yamaha dealer charge the battery. If you charge the battery yourself, carefully read the battery charger instructions before charging and follow the points below.

1. Remove all caps from the battery cell.
2. Add distilled water to the specified level if the electrolyte level is low.
3. Set the charging rate to 1.9 ampere and charge the battery slowly until the explosive gases are discharged vigorously from the battery cells.

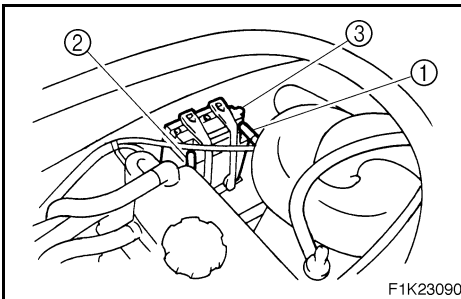
**To connect the battery terminals:**

1. Make sure that the connections are correct when you install the battery in the watercraft.
2. Make sure that the breather hose is properly connected and that it is not damaged or obstructed.
3. Make sure that the battery is securely held in place.

- ① Positive (+): Red lead
- ② Negative (-): Black lead
- ③ Breather hose



EJU18231

Adjusting the fuel injection system

The fuel injection system was set at the Yamaha factory. Have a Yamaha dealer service the watercraft if necessary.

CAUTION:

Do not attempt to adjust the fuel injection system. If the settings are changed poor engine performance and damage may result.

EJU18240

Checking the trolling speed

1. Put the watercraft in the water.
2. Start the engine and warm it up. Use the tachometer in the multifunction meter to check the trolling speed.

Trolling speed: 1,550–1,750 r/min

If the trolling speed is out of specification, have a Yamaha dealer make this adjustment.

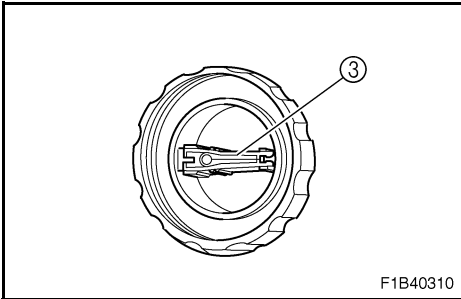
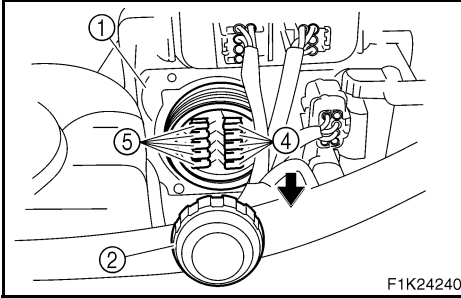

EJU21321

Replacing the fuses

The fuses are in the electrical box ①.

To replace a fuse:

1. Remove the cap ②.
2. Replace the fuse ④ with the spare fuse ⑤ of the correct amperage by using the special tool ③ on the reverse side of the cap.

Fuse amperage:

- 30 A (battery)
- 10 A (main relay)
- 10 A (electronic throttle valve)
- 3 A (security system)
- 20 A (main)

⚠WARNING

Do not use fuses of higher amperage than those recommended. Substitution with a fuse that has an improper rating can cause extensive electrical system damage and possible fire.



EJU13590

Specifications

ITEM	MODEL	Unit	VX110 Sport/VX110 Deluxe
WATERCRAFT CAPACITY			
Maximum people on board		Number of people	3
Maximum load capacity		kg (lb)	240 (530)
DIMENSIONS			
Length		mm (in)	3,220 (126.8)
Width		mm (in)	1,170 (46.1)
Height		mm (in)	1,150 (45.3)
Dry weight		kg (lb)	325 (716)
PERFORMANCE			
Maximum output		kW (PS) @ r/min	75.0 (102)@ 8,000
Maximum fuel consumption		L/h (US gal/h, Imp gal/h)	28 (7.4, 6.2)
Cruising range at full throttle		hr.	2.14
Trolling speed		r/min	1,550–1,750
ENGINE			
Engine type			4-stroke
Number of cylinders			4
Engine displacement		cm ³ (cu in)	1,052 (64.2)
Bore & stroke		mm (in)	76 × 58 (2.99 × 2.28)
Compression ratio			11.4:1
Lubrication system			Dry sump
Cooling system			Water cooled
Starting system			Electric starter
Ignition system			TCI
Spark plug			CR9EB (NGK)
Spark plug gap		mm (in)	0.7–0.8 (0.028–0.031)
Battery capacity		V-AH	12-19
Charging system			Flywheel magneto



ITEM	MODEL	Unit	VX110 Sport/VX110 Deluxe
DRIVE UNIT			
Propulsion system			Jet pump
Jet pump type			Axial flow, single stage
Impeller rotation			Counterclockwise (viewed from rear)
Jet thrust nozzle horizontal angle		Degree	24 + 24
FUEL AND OIL			
Recommended fuel			Regular unleaded gasoline
Minimum octane rating		PON RON	86 90
Recommended engine oil			SAE 10W-30, 20W-40, 20W-50 API SE, SF, SG, SH, SJ, SL
Fuel tank capacity			
Total		L (US gal, Imp gal)	60 (15.9, 13.2)
Engine oil quantity			
With oil filter replacement		L (US qt, Imp qt)	2.2 (2.3, 1.9)
Without oil filter replacement		L (US qt, Imp qt)	2.0 (2.1, 1.8)
Total amount		L (US qt, Imp qt)	4.3 (4.5, 3.8)



-MEMO-

EJU11150

TROUBLESHOOTING AND EMERGENCY PROCEDURES

Troubleshooting	5-1
Troubleshooting chart	5-1
Emergency procedures	5-3
Cleaning the jet intake and impeller	5-3
Jumping the battery	5-5
Towing the watercraft	5-7
Submerged watercraft	5-8





EJU11160

Troubleshooting

If you have any trouble with your watercraft, use this section to check for the possible cause.

If you cannot find the cause, or if the procedure for replacement or repair is not described in this Owner's/Operator's Manual, have a Yamaha dealer perform the necessary service.

EJU13670

Troubleshooting chart

TROUBLE	POSSIBLE CAUSE		REMEDY	PAGE
Engine does not start	Starter motor does not turn over			
	Yamaha Security System (VX110 Deluxe)	Lock mode selected	Select unlock mode	2-15
	Engine shut-off switch	Clip not in place	Install clip	2-9
	Fuse	Burned out	Replace the fuse and check wiring	4-22
	Battery	Run down	Recharge	4-19
		Poor terminal connections	Tighten as required	4-19
		Terminal corroded	Clean	4-5
	Starter motor	Faulty	Have serviced by Yamaha dealer	—
	Starter motor turns over			
	Throttle lever	Squeezed	Release	2-10
	Fuel	Empty	Refill as soon as possible	3-4
		Stale or contaminated	Have serviced by Yamaha dealer	4-10
	Fuel tank	Water or dirt present	Have serviced by Yamaha dealer	4-10
	Spark plug	Fouled or defective	Clean or replace	4-15
	Spark plug cap	Not connected or loose	Connect properly	4-15
Connected to wrong cylinder		Connect properly	4-15	
Fuel injection system	Fuel pump faulty	Have serviced by Yamaha dealer	—	



TROUBLE	POSSIBLE CAUSE		REMEDY	PAGE
Engine runs irregularly or stalls	Fuel	Empty	Refill as soon as possible	3-4
		Stale or contaminated	Have serviced by Yamaha dealer	4-10
	Fuel tank	Water or dirt present	Have serviced by Yamaha dealer	4-10
	Spark plug	Fouled or defective	Replace	4-15
		Incorrect heat range	Replace	4-15
		Gap incorrect	Adjust	4-15
	Spark plug cap	Loose	Connect properly	4-15
		Cracked, torn, or damaged	Replace	—
	Electrical wiring	Loose connection	Tighten or connect properly	—
Fuel injection system	Jet nozzle clogged	Have serviced by Yamaha dealer	—	
Warning light or indicator blinks	Fuel level	Empty	Refill as soon as possible	3-4
	Engine overheated	Jet intake clogged	Clean	5-3
	Check engine warning	Faulty sensors	Have serviced by Yamaha dealer	—
Watercraft slow or loses power	Yamaha Security System (VX110 Deluxe)	Low-RPM mode selected	Select normal mode	2-15
	Cavitation	Jet intake clogged	Clean	5-3
		Impeller damaged or worn	Have serviced by Yamaha dealer	—
	Engine overheat warning	Engine speed reduction control activated	Clean jet intake and cool engine	2-22
	Oil pressure warning	Engine speed reduction control activated	Add oil	2-21
	Spark plug	Fouled or defective	Replace	4-15
		Incorrect heat range	Replace	4-15
		Gap incorrect	Adjust	4-15
	Spark plug caps	Loose	Connect properly	4-15
	Electrical wiring	Loose connection	Tighten or connect properly	—
	Fuel	Stale or contaminated	Have serviced by Yamaha dealer	4-10
	Air filter	Clogged or oil buildup	Have serviced by Yamaha dealer	4-13

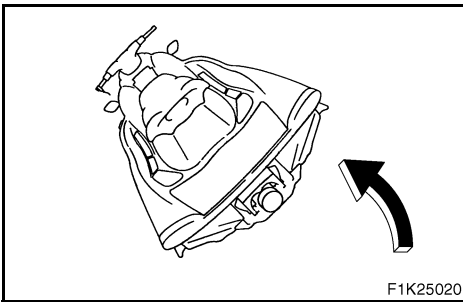
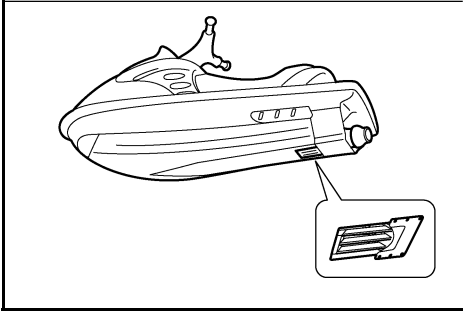
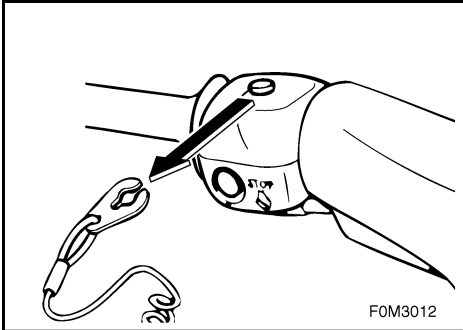

EJU11180

Emergency procedures

EJU21601

Cleaning the jet intake and impeller

If weeds or debris get caught in the intake or impeller, cavitation can occur, causing jet thrust to decrease even though engine speed rises. If this condition is allowed to continue, the engine will overheat and may seize. If there is any sign that the jet intake or impeller is clogged with weeds or debris, beach the watercraft and check the intake and impeller. Always stop the engine before beaching the watercraft.

⚠WARNING

Before attempting to remove weeds or debris from the jet intake or impeller areas, shut the engine off and remove the clip from the engine shut-off switch. Severe injury or death could result from contact with the rotating parts of the jet pump.

CAUTION:

If weeds or debris get caught in the intake, do not operate the watercraft above trolling speed until they have been removed.

1. Turn the watercraft on its side as shown.

CAUTION:

- Place a suitable clean cloth or carpeting underneath the watercraft to protect it from abrasions and scratches.
- Always turn the watercraft over onto its port (left) side.
- When turning the watercraft on its side, support the bow so the handlebars cannot be bent or damaged.



2. Remove any weeds or debris from around the drive shaft, impeller, pump housing, and jet thrust nozzle.

If debris is difficult to remove, consult your Yamaha dealer.

CAUTION:

Always avoid operating your watercraft in areas where weed growth is thick. If traveling in weeded areas is unavoidable, operate the engine alternately at partial throttle and full throttle. Weeds tend to accumulate more at a steady speed and at trolling speed. If weeds clog the intake or impeller area and cause cavitation, follow the cleaning procedure above.



EJU18440

Jumping the battery

If the watercraft battery has run down, the engine can be started using a 12-volt battery and jumper cables.

⚠WARNING

Battery electrolyte is poisonous and dangerous, causing severe burns, etc. Electrolyte contains sulfuric acid. Avoid contact with skin, eyes or clothing.

Antidotes

External: Flush with water.

Internal: Drink large quantities of water or milk. Follow with milk of magnesia, beaten egg or vegetable oil. Call physician immediately.

Eyes: Flush with water for 15 minutes and get prompt medical attention.

Batteries produce explosive gases. Keep sparks, flame, cigarettes, etc. well away. If using or charging the battery in an enclosed space, make sure that it is well ventilated. Always shield your eyes when working near batteries.

KEEP OUT OF THE REACH OF CHILDREN.

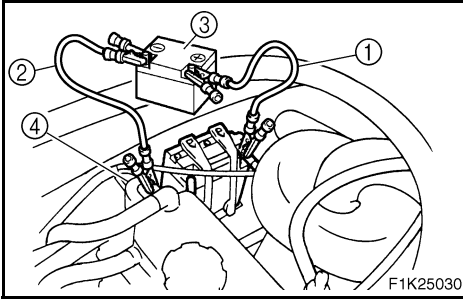

EJU18450

Connecting the jumper cables

1. Connect the positive (+) jumper cable ① to the positive (+) terminals of both batteries.
2. Connect one end of the negative (-) jumper cable ② to the negative (-) terminal of the booster battery ③.
3. Connect the other end of the negative (-) cable to an engine hanger ④.

CAUTION:

Do not connect the end of the jumper cable to the negative (-) terminal on the watercraft battery! Be sure all connections are secure and correct before attempting to start the engine. Any wrong connection may damage the electrical system.

4. Start the engine, and then disconnect the cables by reversing the steps above.

CAUTION:

- Never push the start switch while the engine is running.
- Do not operate the start switch for more than 5 seconds, otherwise the battery will be discharged and the engine will not start. Also, the starter motor may be damaged. If the engine does not start in 5 seconds, release the start switch, wait 15 seconds, and then try again.



EJU19130

Towing the watercraft

If the watercraft becomes inoperative in the water, it can be towed to shore.

If the watercraft must be towed in an emergency using a towline, the operator should ride the watercraft, holding onto the handlebars.

CAUTION:

- Tow the watercraft at 5 mph (8 km/h) or less, otherwise water could enter the engine through the exhaust passages or through the air intake and flood the engine compartment if it is towed too fast.
- Tow the watercraft using the bow eye ① only.
- The bow must be kept up out of the water during towing to prevent water from entering the engine compartment.

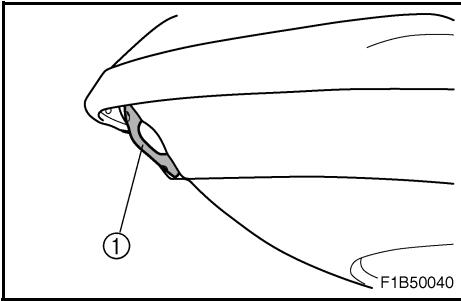

⚠WARNING

- The watercraft should only be towed in an emergency.
- The towline should be long enough so that the watercraft will not collide with the towing boat when slowing down. A good rule of thumb is a towline that is three times the combined length of the towing boat and the watercraft.
- The operator of the towing boat must keep speed to a minimum and avoid traffic or obstacles which could be a hazard to the rider on the watercraft.



EJU19020

Submerged watercraft

If the watercraft is submerged or flooded with water, follow the procedure below and consult a Yamaha dealer as soon as possible. Failure to do so may result in serious engine damage!

In an emergency:

1. Beach the watercraft and remove the stern drain plugs to drain the water from the engine compartment. (See page 3-9 for further instructions.)
Remove the storage compartment plugs to drain the water from each storage compartment.
2. Install the stern drain plugs.
3. Have the watercraft inspected by a Yamaha dealer as soon as possible.



-MEMO-

EJU11240

APPENDIX

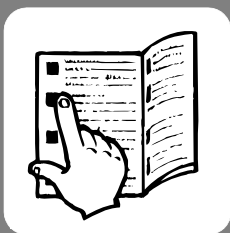

Index6-1



Index

A
Adjusting the fuel injection system 4-21
Approval label of emission control certificate 1-3

B
Battery 3-10, 4-5
Beaching the watercraft 3-32
Bilge 3-9
Boarding alone 3-24
Boarding and starting in deep water 3-24
Boarding with passengers 3-25

C
Capsized watercraft 3-27
Changing the engine oil 4-11
Check engine warning indicator 2-20
Checking the air filter element 4-13
Checking the trolling speed 4-21
Cleaning and adjusting the spark plugs 4-15
Cleaning the jet intake and impeller 5-3
Cleaning the watercraft 4-6
Connecting the jumper cables 5-6
Cooling water pilot outlet 2-11, 3-14
Cruising limitations 1-12

D
Docking the watercraft 3-32

E
Emergency procedures 5-3
Emission control information (For Canada only) 1-3
Engine break-in 3-15
Engine compartment 3-6
Engine oil 3-3
Engine oil level 3-7
Engine overheat warning indicator 2-22
Engine serial number 1-2
Engine shut-off cord (lanyard) 3-13
Engine shut-off switch 2-9
Engine stop switch 2-9
Enjoy your watercraft responsibly 1-20

F
Filling the fuel tank 3-4
Fire extinguisher 3-11
Flushing the cooling system 4-1
Front storage compartment 2-24
Fuel and oil 3-1
Fuel level 3-6
Fuel meter 2-19
Fuel system 4-4
Fuel tank 4-10
Fuel tank filler cap 2-6
Fuel warning indicator 2-21

G
Gasohol 3-2
Gasoline 3-1
Getting to know your watercraft 3-20
Glove compartment 2-25

H
Handgrip 2-14
Hazard information 1-16
Hood 2-6
Hour meter/Voltmeter 2-20
Hull and deck 3-6
Hull Identification Number (HIN) 1-2

I
Identification numbers 1-1
Important labels 1-4
Inspecting and adjusting the throttle cable 4-14
Inspecting the battery 4-19
Inspecting the fuel system 4-10
Inspecting the jet thrust nozzle angle 4-13
Inspecting the shift cable (for VX110 Deluxe) 4-13

J
Jet unit 3-13
Jumping the battery 5-5

L
Label location 1-4
Launching the watercraft 3-16
Learning to operate your watercraft 3-20
Leaving the watercraft 3-19



Limitations on who may operate the watercraft	1-11	Selecting the normal mode/low-RPM mode (for VX110 Deluxe).....	2-17
“L-MODE” indicator light (for VX110 Deluxe).....	2-23	Shift lever and reverse gate (for VX110 Deluxe).....	3-12
Location of main components	2-1	Shift lever (for VX110 Deluxe).....	2-13
Lubrication.....	4-3	Specifications	4-23
Lubrication points	4-17	Speedometer.....	2-19
M		Starting and boarding in shallow water	3-23
Maintenance and adjustments	4-7	Starting from a dock	3-23
Manufactured date label.....	1-3	Starting the engine	3-17
Multifunction meter.....	2-18, 3-14	Starting the watercraft	3-22
O		Start switch.....	2-10
Oil pressure warning indicator.....	2-21	Steering system	2-12, 3-12
Operating your watercraft.....	3-20	Stern drain plug.....	3-9
Operation	3-15	Stopping the engine	3-19
Operation of controls and other functions.....	2-5	Stopping the watercraft	3-31
Operation requirements	1-13	Storage.....	4-1
Other labels.....	1-9	Storage compartments	2-24
Owner’s/Operator’s Manual and tool kit.....	4-8	Submerged watercraft.....	5-8
P		Switches	3-14
Periodic maintenance chart.....	4-9	T	
Post-operation checks.....	3-34	Tachometer	2-19
Pre-operation check list.....	3-5	Throttle	3-11
Pre-operation check points	3-6	Throttle lever	2-10
Pre-operation checks	3-5	Towing the watercraft.....	5-7
Primary Identification (PRI-ID) number ...	1-1	Transporting	3-36
R		Troubleshooting	5-1
Recommended equipment.....	1-15	Troubleshooting chart	5-1
Remote control transmitter (for VX110 Deluxe).....	2-7	Turning the watercraft	3-29
Replacing the fuses.....	4-22	W	
Reverse on waterways (for VX110 Deluxe).....	3-33	Warning labels	1-5
Riding watercraft with passengers	3-21	Watercraft characteristics.....	1-16
Rough water operation.....	3-33	Water separator	3-8
S		Water-skiing	1-18
Safe boating rules	1-20	Y	
Safety information	1-11	Yamaha Engine Management System (YEMS).....	2-15
Seat.....	2-5	Yamaha Security System (for VX110 Deluxe).....	2-15
“SECURITY” indicator light (for VX110 Deluxe).....	2-23	Yamaha Security System lock and unlock modes (for VX110 Deluxe)	2-16
		Yamaha Security System/Low-RPM mode (for VX110 Deluxe).....	2-15



Printed in USA
Dec. 2004—0.8 × 1 CR
F1K-F8199-70
(E)