



OWNER'S MANUAL



TW125

5RS-28199-E2

Welcome to the Yamaha world of motorcycling!

As the owner of the TW125, you are benefiting from Yamaha's vast experience and newest technology regarding the design and manufacture of high-quality products, which have earned Yamaha a reputation for dependability.

Please take the time to read this manual thoroughly, so as to enjoy all advantages of your TW125. The owner's manual does not only instruct you in how to operate, inspect and maintain your motorcycle, but also in how to safeguard yourself and others from trouble and injury.



In addition, the many tips given in this manual will help keep your motorcycle in the best possible condition. If you have any further questions, do not hesitate to contact your Yamaha dealer.

The Yamaha team wishes you many safe and pleasant rides. So, remember to put safety first!

IMPORTANT MANUAL INFORMATION

EAU10150

Particularly important information is distinguished in this manual by the following notations:

	The Safety Alert Symbol means ATTENTION! BECOME ALERT! YOUR SAFETY IS INVOLVED!
	Failure to follow WARNING instructions could result in severe injury or death to the motorcycle operator, a bystander, or a person inspecting or repairing the motorcycle.
CAUTION:	A CAUTION indicates special precautions that must be taken to avoid damage to the motorcycle.
NOTE:	A NOTE provides key information to make procedures easier or clearer.

NOTE:

- This manual should be considered a permanent part of this motorcycle and should remain with it even if the motorcycle is subsequently sold.
- Yamaha continually seeks advancements in product design and quality. Therefore, while this manual contains the most current product information available at the time of printing, there may be minor discrepancies between your motorcycle and this manual. If you have any questions concerning this manual, please consult your Yamaha dealer.

EWA10030



PLEASE READ THIS MANUAL CAREFULLY AND COMPLETELY BEFORE OPERATING THIS MOTORCYCLE.

IMPORTANT MANUAL INFORMATION

EAU10200

**TW125
OWNER'S MANUAL
©2003 by Yamaha Motor Co., Ltd.
1st edition, August 2003
All rights reserved.
Any reprinting or unauthorized use
without the written permission of
Yamaha Motor Co., Ltd.
is expressly prohibited.
Printed in Japan.**

TABLE OF CONTENTS

SAFETY INFORMATION	1-1	Ignition circuit cut-off system ...	3-11	Adjusting the engine idling speed	6-12
DESCRIPTION	2-1	PRE-OPERATION CHECKS	4-1	Adjusting the throttle cable free play	6-13
Left view	2-1	Pre-operation check list	4-2	Adjusting the valve clearance	6-13
Right view.....	2-2	OPERATION AND IMPORTANT RIDING POINTS	5-1	Tires	6-13
Controls and instruments	2-3	Starting a cold engine	5-1	Spoke wheels	6-16
INSTRUMENT AND CONTROL FUNCTIONS	3-1	Starting a warm engine	5-2	Adjusting the clutch lever free play	6-16
Main switch	3-1	Shifting	5-2	Adjusting the brake lever free play	6-17
Indicator lights	3-1	Tips for reducing fuel consumption	5-3	Adjusting the brake pedal position and free play	6-18
Speedometer unit	3-2	Engine break-in	5-4	Adjusting the rear brake light switch	6-19
Handlebar switches	3-3	Parking	5-4	Checking the front brake pads and rear brake shoes	6-19
Clutch lever	3-4	PERIODIC MAINTENANCE AND MINOR REPAIR.....	6-1	Checking the brake fluid level	6-20
Shift pedal	3-4	Owner's tool kit	6-1	Changing the brake fluid	6-21
Brake lever	3-4	Periodic maintenance and lubrication chart	6-2	Drive chain slack	6-21
Brake pedal	3-5	Removing and installing panels	6-5	Lubricating the drive chain	6-23
Fuel tank cap	3-5	Checking the spark plug	6-6	Checking and lubricating the cables	6-23
Fuel	3-6	Engine oil and oil filter element	6-7	Checking and lubricating the throttle grip and cable	6-24
Fuel cock	3-7	Cleaning the air filter element and check hose	6-10		
Starter (choke) knob “ N ”	3-8	Adjusting the carburetor	6-12		
Steering lock	3-8				
Seat	3-9				
Helmet holder	3-9				
Shock absorber	3-10				
Carrier	3-10				
Luggage strap holders	3-10				
Sidestand	3-11				

TABLE OF CONTENTS

Checking and lubricating the brake and shift pedals	6-24	Storage	7-3
Checking and lubricating the brake and clutch levers	6-24	SPECIFICATIONS	8-1
Checking and lubricating the sidestand	6-25	CONSUMER INFORMATION	9-1
Lubricating the rear suspension	6-25	Identification numbers	9-1
Checking the front fork	6-25		
Checking the steering	6-26		
Checking the wheel bearings	6-27		
Battery	6-27		
Replacing the fuse	6-28		
Replacing the headlight bulb ...	6-29		
Replacing the tail/brake light bulb	6-31		
Replacing a turn signal light bulb	6-31		
Supporting the motorcycle	6-32		
Front wheel	6-33		
Rear wheel	6-34		
Troubleshooting	6-36		
Troubleshooting chart	6-37		
MOTORCYCLE CARE AND			
STORAGE.....			
Care	7-1		

SAFETY INFORMATION

1

MOTORCYCLES ARE SINGLE TRACK VEHICLES. THEIR SAFE USE AND OPERATION ARE DEPENDENT UPON THE USE OF PROPER RIDING TECHNIQUES AS WELL AS THE EXPERTISE OF THE OPERATOR. EVERY OPERATOR SHOULD KNOW THE FOLLOWING REQUIREMENTS BEFORE RIDING THIS MOTORCYCLE.

EAU10310

HE OR SHE SHOULD:

- OBTAIN THOROUGH INSTRUCTIONS FROM A COMPETENT SOURCE ON ALL ASPECTS OF MOTORCYCLE OPERATION.
- OBSERVE THE WARNINGS AND MAINTENANCE REQUIREMENTS IN THE OWNER'S MANUAL.
- OBTAIN QUALIFIED TRAINING IN SAFE AND PROPER RIDING TECHNIQUES.
- OBTAIN PROFESSIONAL TECHNICAL SERVICE AS INDICATED BY THE OWNER'S MANUAL AND/OR WHEN MADE NECES-

SARY BY MECHANICAL CONDITIONS.

Safe riding

- Always make pre-operation checks. Careful checks may help prevent an accident.
- This motorcycle is designed to carry the operator and a passenger.
- The failure of motorists to detect and recognize motorcycles in traffic is the predominating cause of automobile/motorcycle accidents. Many accidents have been caused by an automobile driver who did not see the motorcycle. Making yourself conspicuous appears to be very effective in reducing the chance of this type of accident.
- **Therefore:**
 - Wear a brightly colored jacket.
 - Use extra caution when approaching and passing through intersections, since intersections are the most likely places for motorcycle accidents to occur.

- Ride where other motorists can see you. Avoid riding in another motorist's blind spot.
- Many accidents involve inexperienced operators. In fact, many operators who have been involved in accidents do not even have a current motorcycle license.
 - Make sure that you are qualified and that you only lend your motorcycle to other qualified operators.
 - Know your skills and limits. Staying within your limits may help you to avoid an accident.
 - We recommend that you practice riding your motorcycle where there is no traffic until you have become thoroughly familiar with the motorcycle and all of its controls.
- Many accidents have been caused by error of the motorcycle operator. A typical error made by the operator is veering wide on a turn due to EXCESSIVE SPEED or

undercornering (insufficient lean angle for the speed).

- Always obey the speed limit and never travel faster than warranted by road and traffic conditions.
- Always signal before turning or changing lanes. Make sure that other motorists can see you.
- The posture of the operator and passenger is important for proper control.
 - The operator should keep both hands on the handlebar and both feet on the operator footrests during operation to maintain control of the motorcycle.
 - The passenger should always hold onto the operator, the seat strap or grab bar, if equipped, with both hands and keep both feet on the passenger footrests.
 - Never carry a passenger unless he or she can firmly place both feet on the passenger footrests.
- Never ride under the influence of alcohol or other drugs.

Protective apparel

The majority of fatalities from motorcycle accidents are the result of head injuries. The use of a safety helmet is the single most critical factor in the prevention or reduction of head injuries.

- Always wear an approved helmet.
- Wear a face shield or goggles. Wind in your unprotected eyes could contribute to an impairment of vision that could delay seeing a hazard.
- The use of a jacket, heavy boots, trousers, gloves, etc., is effective in preventing or reducing abrasions or lacerations.
- Never wear loose-fitting clothes, otherwise they could catch on the control levers, footrests, or wheels and cause injury or an accident.
- Never touch the engine or exhaust system during or after operation. They become very hot and can cause burns. Always wear protective clothing that covers your legs, ankles, and feet.

- Passengers should also observe the precautions mentioned above.

Modifications

Modifications made to this motorcycle not approved by Yamaha, or the removal of original equipment, may render the motorcycle unsafe for use and may cause severe personal injury. Modifications may also make your motorcycle illegal to use.

Loading and accessories

Adding accessories or cargo to your motorcycle can adversely affect stability and handling if the weight distribution of the motorcycle is changed. To avoid the possibility of an accident, use extreme caution when adding cargo or accessories to your motorcycle. Use extra care when riding a motorcycle that has added cargo or accessories. Here are some general guidelines to follow if loading cargo or adding accessories to your motorcycle:

Loading

The total weight of the operator, passenger, accessories and cargo must

SAFETY INFORMATION

not exceed the maximum load limit of 180 kg (397 lb) . When loading within this weight limit, keep the following in mind:

- Cargo and accessory weight should be kept as low and close to the motorcycle as possible. Make sure to distribute the weight as evenly as possible on both sides of the motorcycle to minimize imbalance or instability.
- Shifting weights can create a sudden imbalance. Make sure that accessories and cargo are securely attached to the motorcycle before riding. Check accessory mounts and cargo restraints frequently.
- Never attach any large or heavy items to the handlebar, front fork, or front fender. These items, including such cargo as sleeping bags, duffel bags, or tents, can create unstable handling or a slow steering response.

Accessories

Genuine Yamaha accessories have

been specifically designed for use on this motorcycle. Since Yamaha cannot test all other accessories that may be available, you must personally be responsible for the proper selection, installation and use of non-Yamaha accessories. Use extreme caution when selecting and installing any accessories.

Keep the following guidelines in mind, as well as those provided under “Loading” when mounting accessories.

- Never install accessories or carry cargo that would impair the performance of your motorcycle. Carefully inspect the accessory before using it to make sure that it does not in any way reduce ground clearance or cornering clearance, limit suspension travel, steering travel or control operation, or obscure lights or reflectors.
- Accessories fitted to the handlebar or the front fork area can create instability due to improper weight distribution or aerody-

dynamic changes. If accessories are added to the handlebar or front fork area, they must be as lightweight as possible and should be kept to a minimum.

- Bulky or large accessories may seriously affect the stability of the motorcycle due to aerodynamic effects. Wind may attempt to lift the motorcycle, or the motorcycle may become unstable in cross winds. These accessories may also cause instability when passing or being passed by large vehicles.
- Certain accessories can displace the operator from his or her normal riding position. This improper position limits the freedom of movement of the operator and may limit control ability, therefore, such accessories are not recommended.
- Use caution when adding electrical accessories. If electrical accessories exceed the capacity of the

motorcycle's electrical system an electric failure could result, which could cause a dangerous loss of lights or engine power.

Gasoline and exhaust gas

- **GASOLINE IS HIGHLY FLAMMABLE:**
 - Always turn the engine off when refueling.
 - Take care not to spill any gasoline on the engine or exhaust system when refueling.
 - Never refuel while smoking or in the vicinity of an open flame.
- Never start the engine or let it run for any length of time in a closed area. The exhaust fumes are poisonous and may cause loss of consciousness and death within a short time. Always operate your motorcycle in an area that has adequate ventilation.
- Always turn the engine off before leaving the motorcycle unattended and remove the key from the main switch. When parking the motorcy-

cle, note the following:

- The engine and exhaust system may be hot, therefore, park the motorcycle in a place where pedestrians or children are not likely to touch these hot areas.
- Do not park the motorcycle on a slope or soft ground, otherwise it may fall over.
- Do not park the motorcycle near a flammable source (e.g., a kerosene heater, or near an open flame), otherwise it could catch fire.
- When transporting the motorcycle in another vehicle, make sure that it is kept upright and that the fuel cock(s) are turned to "ON" or "RES" (for vacuum type)/"OFF" (for manual type). If the motorcycle should lean over, gasoline may leak out of the carburetor or fuel tank.
- If you should swallow any gasoline, inhale a lot of gasoline vapor, or allow gasoline to get into your

eyes, see your doctor immediately. If any gasoline spills on your skin or clothing, immediately wash the affected area with soap and water and change your clothes.

DESCRIPTION

EAU10410

Left view

2

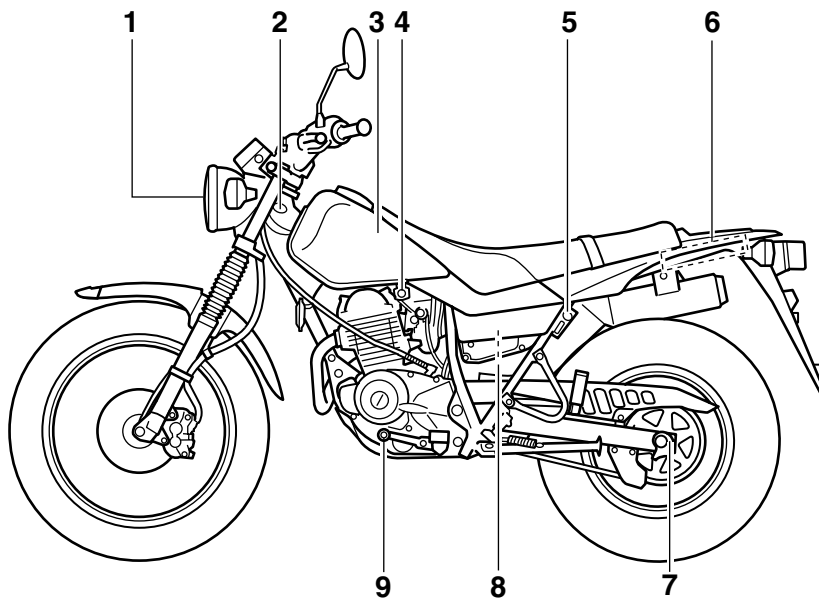

- 1. Headlight (page 6-29)
- 2. Steering lock (page 3-8)
- 3. Fuel tank (page 3-5)
- 4. Fuel cock (page 3-7)
- 5. Helmet holder (page 3-9)
- 6. Luggage strap holder (page 3-10)
- 7. Drive chain slack adjusting plate
- 8. Air filter element (page 6-10)

9. Shift pedal (page 3-4)

Right view

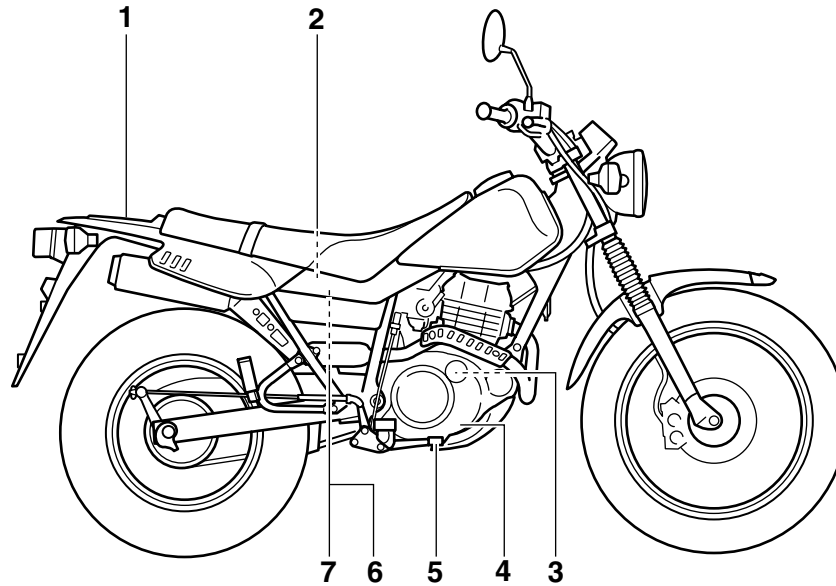

1. Carrier
2. Battery (page 6-27)
3. Engine oil filter element (page 6-7)
4. Engine oil level check window (page 6-7)
5. Brake pedal (page 3-5)
6. Owner's tool kit (page 6-1)
7. Fuse (page 6-28)

DESCRIPTION

EAU10430

Controls and instruments

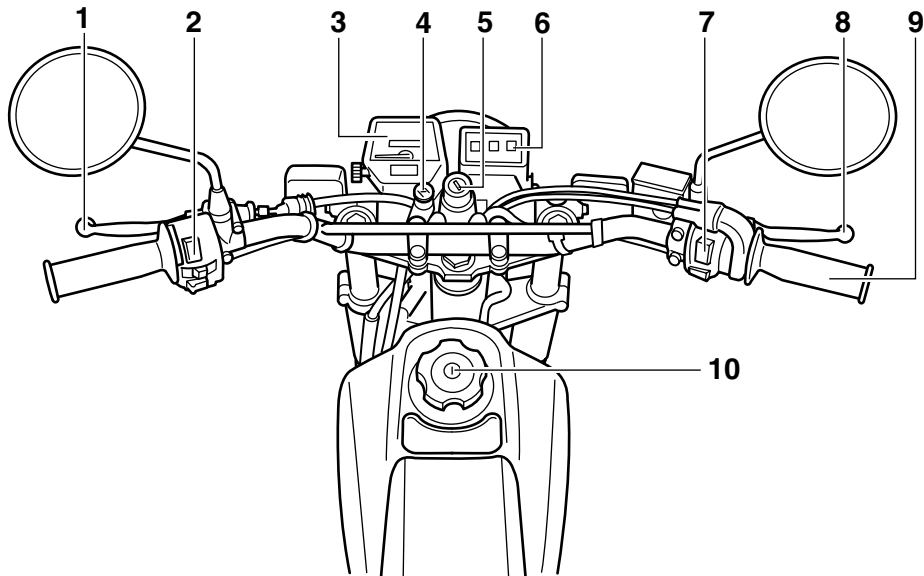

1. Clutch lever (page 3-4)

2. Left handlebar switches (page 3-3)

3. Speedometer unit (page 3-2)

4. Starter (choke) knob (page 3-8)

5. Main switch (page 3-1)

6. Indicator lights (page 3-1)

7. Right handlebar switches (page 3-3)

8. Brake lever (page 3-4)

9. Throttle grip (page 6-13)

10. Fuel tank cap (page 3-5)

INSTRUMENT AND CONTROL FUNCTIONS

Main switch

EAU10450

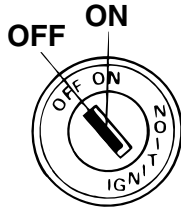

The main switch controls the ignition and lighting systems. The various main switch positions are described below.

EAU10570

ON

All electrical circuits are supplied with power; the meter lighting, taillight and auxiliary light come on, and the engine can be started. The key cannot be removed.

NOTE:

The headlight comes on automatically when the engine is started and stays on until the key is turned to "OFF".

OFF

All electrical systems are off. The key can be removed.

EAU10660

Indicator lights

EAU10980

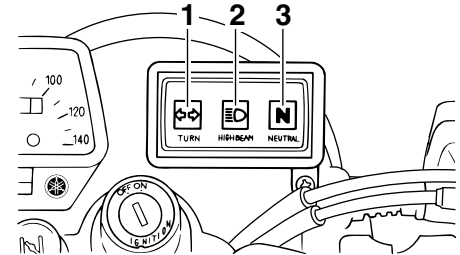

1. Turn signal indicator light “ ”
2. High beam indicator light “”
3. Neutral indicator light “**N**”

EAU11020

Turn signal indicator light “ ”

This indicator light flashes when the turn signal switch is pushed to the left or right.

EAU11060

Neutral indicator light “**N**”

This indicator light comes on when the transmission is in the neutral position.

EAU11080

High beam indicator light “”

This indicator light comes on when the high beam of the headlight is switched

INSTRUMENT AND CONTROL FUNCTIONS

on.

EAU11640

Speedometer unit

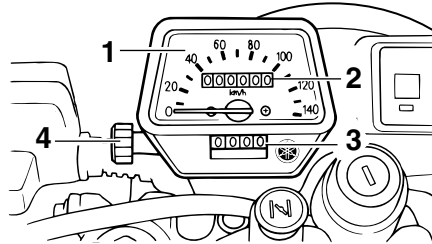

1. Speedometer
2. Odometer
3. Tripmeter
4. Reset knob

The speedometer unit is equipped with a speedometer, an odometer and a tripmeter. The speedometer shows riding speed. The odometer shows the total distance traveled. The tripmeter shows the distance traveled since it was last set to zero with the reset knob. The tripmeter can be used to estimate the distance that can be traveled with a full tank of fuel. This information will enable you to plan future fuel stops.

NOTE: _____

Only for the German model equipped with a speed limiter:

The speed limiter prevents the vehicle from exceeding a riding speed of 80 km/h.

INSTRUMENT AND CONTROL FUNCTIONS

Handlebar switches

Left

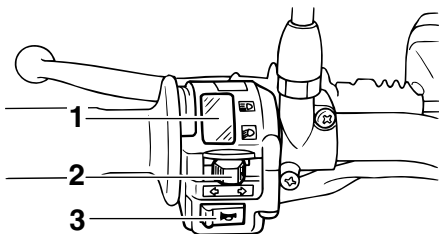

1. Dimmer switch “/”
2. Turn signal switch “/”
3. Horn switch “”

EAU12342

Right

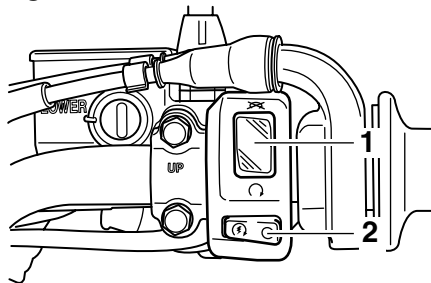

1. Engine stop switch “”
2. Start switch “”

EAU12400

Dimmer switch “/”

Set this switch to “” for the high beam and to “” for the low beam.

EAU12460

Turn signal switch “/”

To signal a right-hand turn, push this switch to “”. To signal a left-hand turn, push this switch to “”. When released, the switch returns to the center position. To cancel the turn signal lights, push the switch in after it has returned to the center position.

EAU12500

Horn switch “”

Press this switch to sound the horn.

EAU12660

Engine stop switch “”

Set this switch to “” before starting the engine. Set this switch to “” to stop the engine in case of an emergency, such as when the vehicle overturns or when the throttle cable is stuck.

EAU12710

Start switch “”

Push this switch to crank the engine with the starter.

ECA10050

CAUTION:

See page 5-1 for starting instructions prior to starting the engine.

INSTRUMENT AND CONTROL FUNCTIONS

Clutch lever

EAU12820

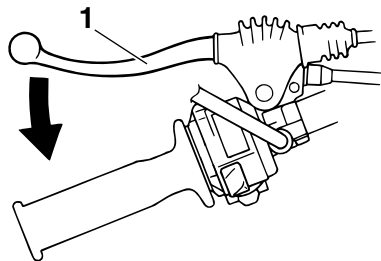

1. Clutch lever

The clutch lever is located at the left handlebar grip. To disengage the clutch, pull the lever toward the handlebar grip. To engage the clutch, release the lever. The lever should be pulled rapidly and released slowly for smooth clutch operation.

The clutch lever is equipped with a clutch switch, which is part of the ignition circuit cut-off system. (See page 3-11.)

Shift pedal

EAU12870

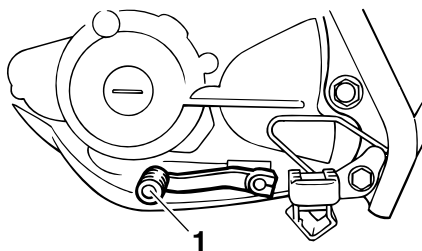

1. Shift pedal

The shift pedal is located on the left side of the engine and is used in combination with the clutch lever when shifting the gears of the 5-speed constant-mesh transmission equipped on this motorcycle.

Brake lever

EAU12890

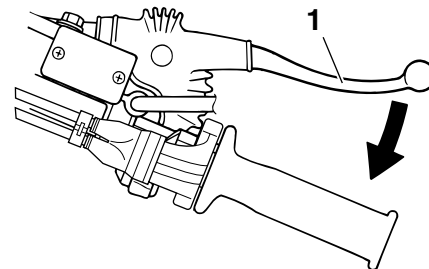

1. Brake lever

The brake lever is located at the right handlebar grip. To apply the front brake, pull the lever toward the handlebar grip.

INSTRUMENT AND CONTROL FUNCTIONS

Brake pedal

EAU12941

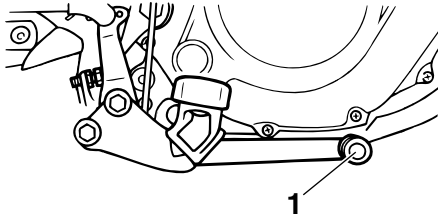

1. Brake pedal

The brake pedal is on the right side of the motorcycle. To apply the rear brake, press down on the brake pedal.

Fuel tank cap

EAU32280

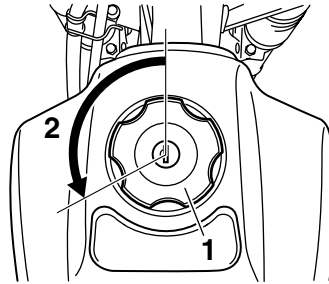

1. Fuel tank cap
2. Unlock.

To remove the fuel tank cap

1. Insert the key into the lock and turn it 1/3 turn counterclockwise.
2. Turn the fuel tank cap 1/3 turn counterclockwise and pull it off.

To install the fuel tank cap

1. Insert the fuel tank cap into the tank opening with the key inserted in the lock, and then turn the cap 1/3 turn clockwise.
2. Turn the key 1/3 turn clockwise, and then remove it.

NOTE: _____

The fuel tank cap cannot be installed

unless the key is in the lock. In addition, the key cannot be removed if the cap is not properly installed and locked.

EWA10120

⚠ WARNING

Make sure that the fuel tank cap is properly closed and locked before riding.

INSTRUMENT AND CONTROL FUNCTIONS

Fuel

EAU13210

fuel may deteriorate painted surfaces or plastic parts.

EAU13320

or premium unleaded fuel. Use of unleaded fuel will extend spark plug life and reduce maintenance costs.

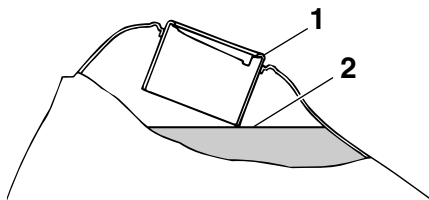

1. Fuel tank filler tube
2. Fuel level

Make sure that there is sufficient fuel in the tank. Fill the fuel tank to the bottom of the filler tube as shown.

EWA10880

⚠ WARNING

- Do not overfill the fuel tank, otherwise it may overflow when the fuel warms up and expands.
- Avoid spilling fuel on the hot engine.

ECA10070

CAUTION:

Immediately wipe off spilled fuel with a clean, dry, soft cloth, since

Recommended fuel:
REGULAR UNLEADED GASOLINE ONLY

Fuel tank capacity:
7.0 L (1.85 US gal)
(1.54 Imp.gal)

Fuel reserve amount:
1.7 L (0.45 US gal)
(0.37 Imp.gal)

ECA11400

CAUTION:

Use only unleaded gasoline. The use of leaded gasoline will cause severe damage to internal engine parts, such as the valves and piston rings, as well as to the exhaust system.

Your Yamaha engine has been designed to use regular unleaded gasoline with a research octane number of 91 or higher. If knocking (or pinging) occurs, use a gasoline of a different brand

INSTRUMENT AND CONTROL FUNCTIONS

EAU13560

Fuel cock

The fuel cock supplies fuel from the tank to the carburetor while filtering it also.

The fuel cock has three positions:

OFF

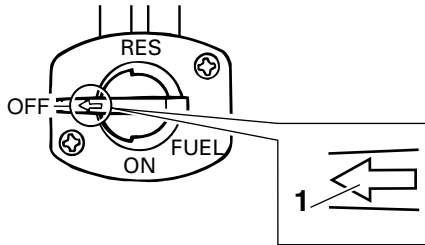

1. Arrow mark positioned over "OFF"

With the lever in this position, fuel will not flow. Always return the lever to this position when the engine is not running.

ON

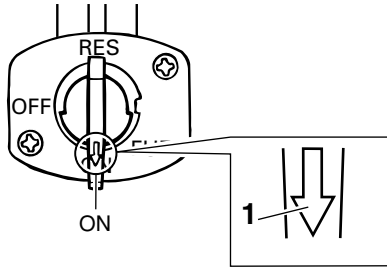

1. Arrow mark positioned over "ON"

With the lever in this position, fuel flows to the carburetor. Normal riding is done with the lever in this position.

RES

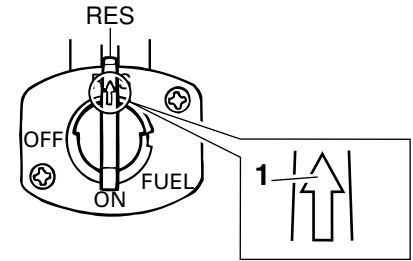



1. Arrow mark positioned over "RES"

This indicates reserve. If you run out of fuel while riding, move the lever to this position. Fill the tank at the first opportunity. Be sure to set the lever back to "ON" after refueling!

INSTRUMENT AND CONTROL FUNCTIONS

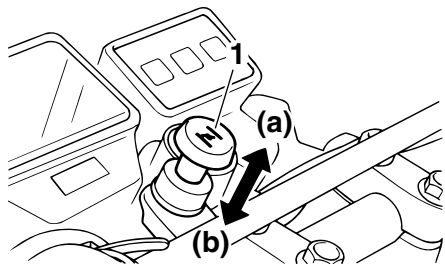
Starter (choke) knob “ EAU13600



1. Starter (choke) knob “

Starting a cold engine requires a richer air-fuel mixture, which is supplied by the starter (choke).

Move the knob in direction (a) to turn on the starter (choke).

Move the knob in direction (b) to turn off the starter (choke).

Steering lock

EAU13770

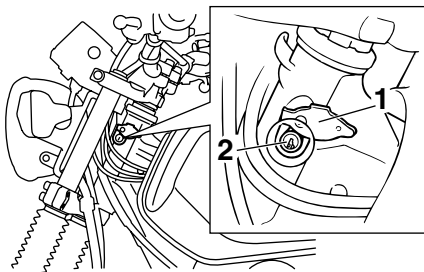

1. Steering lock cover
2. Steering lock

To lock the steering

1. Turn the handlebar all the way to the right.
2. Open the steering lock cover, and then insert the steering lock key.
3. Turn the key 1/8 turn counterclockwise, push it in while turning the handlebar slightly to the left, and then turn the key 1/8 turn clockwise.
4. Check that the steering is locked, remove the key, and then close the lock cover.

To unlock the steering

1. Open the steering lock cover, and then insert the steering lock key.
2. Push the key in, turn it 1/8 turn counterclockwise so that it moves out, and then release it.
3. Remove the key, and then close the lock cover.

INSTRUMENT AND CONTROL FUNCTIONS

Seat

EAU13970

To remove the seat

Remove the bolts, and then pull the seat off.

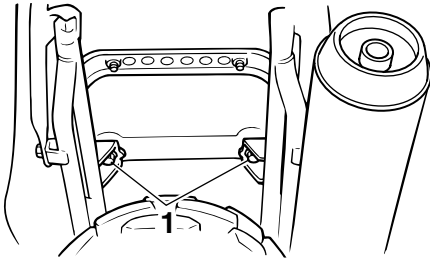

1. Bolt

To install the seat

1. Insert the projection on the front of the seat into the seat holder as shown.

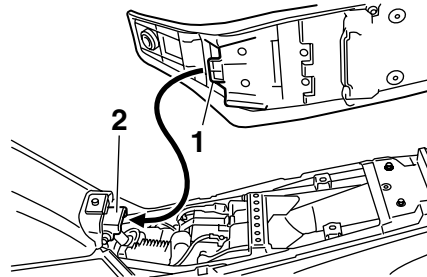

1. Projection
2. Seat holder

2. Place the seat in the original position, and then tighten the bolts.

NOTE: _____
Make sure that the seat is properly secured before riding.

Helmet holder

EAU14281

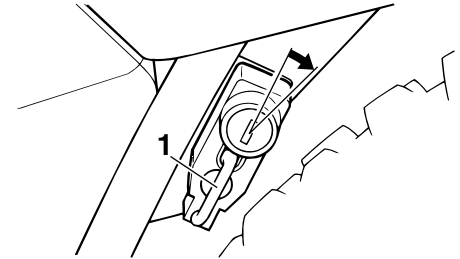

1. Helmet holder

To open the helmet holder, insert the key into the lock, and then turn the key as shown.

To lock the helmet holder, place it in the original position, and then remove the key.

WARNING

EWA10160

Never ride with a helmet attached to the helmet holder, since the helmet may hit objects, causing loss of control and possibly an accident.

INSTRUMENT AND CONTROL FUNCTIONS

Shock absorber

EAU15090

EWA10220

WARNING

This shock absorber contains highly pressurized nitrogen gas. For proper handling, read and understand the following information before handling the shock absorber. The manufacturer cannot be held responsible for property damage or personal injury that may result from improper handling.

- Do not tamper with or attempt to open the gas cylinder.
- Do not subject the shock absorber to an open flame or other high heat sources, otherwise it may explode due to excessive gas pressure.
- Do not deform or damage the gas cylinder in any way, as this will result in poor damping performance.
- Always have a Yamaha dealer service the shock absorber.

Carrier

EAU15110

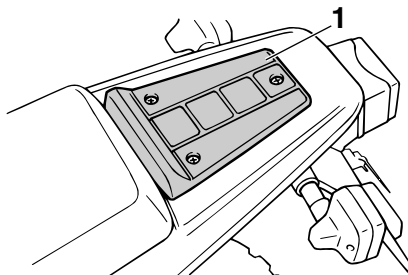

1. Carrier

WARNING

EWA10170

- Do not exceed the load limit of 3 kg (6.6 lb) for the carrier.
- Do not exceed the maximum load of 180 kg (397 lb) for the vehicle.

Luggage strap holders

EAU15170

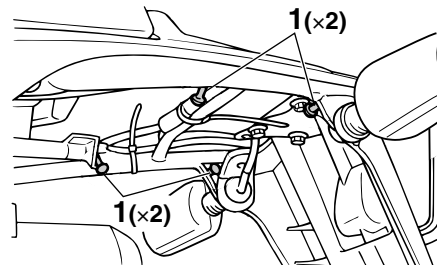

1. Luggage strap holder

There are four luggage strap holders below the carrier.

Sidestand

EAU15300

The sidestand is located on the left side of the frame. Raise the sidestand or lower it with your foot while holding the vehicle upright.

NOTE:

The built-in sidestand switch is part of the ignition circuit cut-off system, which cuts the ignition in certain situations. (See further down for an explanation of the ignition circuit cut-off system.)

EWA10240



The vehicle must not be ridden with the sidestand down, or if the sidestand cannot be properly moved up (or does not stay up), otherwise the sidestand could contact the ground and distract the operator, resulting in a possible loss of control. Yamaha's ignition circuit cut-off system has been designed to assist the operator in fulfilling the responsibility of raising the sidestand before starting off. Therefore, check

this system regularly as described below and have a Yamaha dealer repair it if it does not function properly.

Ignition circuit cut-off system

EAU15311

The ignition circuit cut-off system (comprising the sidestand switch, clutch switch and neutral switch) has the following functions.

- It prevents starting when the transmission is in gear and the sidestand is up, but the clutch lever is not pulled.
- It prevents starting when the transmission is in gear and the clutch lever is pulled, but the sidestand is still down.
- It cuts the running engine when the transmission is in gear and the sidestand is moved down.

Periodically check the operation of the ignition circuit cut-off system according to the following procedure.

EWA10250



If a malfunction is noted, have a Yamaha dealer check the system before riding.

INSTRUMENT AND CONTROL FUNCTIONS

3

With the engine turned off:
1. Move the sidestand down.
2. Make sure that the engine stop switch is turned on.
3. Turn the key on.
4. Shift the transmission into the neutral position.
5. Push the start switch.
Does the engine start?

YES

NO

With the engine still running:
6. Move the sidestand up.
7. Keep the clutch lever pulled.
8. Shift the transmission into gear.
9. Move the sidestand down.
Does the engine stall?

YES

NO

After the engine has stalled:
10. Move the sidestand up.
11. Keep the clutch lever pulled.
12. Push the start switch.
Does the engine start?

YES

NO

The system is OK. **The motorcycle can be ridden.**

NOTE:

This check is most reliable if performed with a warmed-up engine.

The neutral switch may be defective.
The motorcycle should not be ridden until checked by a Yamaha dealer.

The sidestand switch may be defective.
The motorcycle should not be ridden until checked by a Yamaha dealer.

The clutch switch may be defective.
The motorcycle should not be ridden until checked by a Yamaha dealer.

PRE-OPERATION CHECKS

EAU15591

The condition of a vehicle is the owner's responsibility. Vital components can start to deteriorate quickly and unexpectedly, even if the vehicle remains unused (for example, as a result of exposure to the elements). Any damage, fluid leakage or loss of tire air pressure could have serious consequences. Therefore, it is very important, in addition to a thorough visual inspection, to check the following points before each ride.

NOTE:

Pre-operation checks should be made each time the vehicle is used. Such an inspection can be accomplished in a very short time; and the added safety it assures is more than worth the time involved.

EWA11150



If any item in the Pre-operation check list is not working properly, have it inspected and repaired before operating the vehicle.

PRE-OPERATION CHECKS

EAU15602

Pre-operation check list

ITEM	CHECKS	PAGE
Fuel	<ul style="list-style-type: none"> • Check fuel level in fuel tank. • Refuel if necessary. • Check fuel line for leakage. 	3-6
Engine oil	<ul style="list-style-type: none"> • Check oil level in engine. • If necessary, add recommended oil to specified level. • Check vehicle for oil leakage. 	6-7
Front brake	<ul style="list-style-type: none"> • Check operation. • If soft or spongy, have Yamaha dealer bleed hydraulic system. • Check lever free play. • Adjust if necessary. • Check brake pads for wear. • Replace if necessary. • Check fluid level in reservoir. • If necessary, add recommended brake fluid to specified level. • Check hydraulic system for leakage. 	6-17, 6-19, 6-20
Rear brake	<ul style="list-style-type: none"> • Check operation. • Check pedal free play. • Adjust if necessary. 	6-18, 6-19
Clutch	<ul style="list-style-type: none"> • Check operation. • Lubricate cable if necessary. • Check lever free play. • Adjust if necessary. 	6-16
Throttle grip	<ul style="list-style-type: none"> • Make sure that operation is smooth. • Check cable free play. • If necessary, have Yamaha dealer adjust cable free play and lubricate cable and grip housing. 	6-13, 6-24
Control cables	<ul style="list-style-type: none"> • Make sure that operation is smooth. • Lubricate if necessary. 	6-23

4

PRE-OPERATION CHECKS

ITEM	CHECKS	PAGE
Drive chain	<ul style="list-style-type: none"> • Check chain slack. • Adjust if necessary. • Check chain condition. • Lubricate if necessary. 	6-21, 6-23
Wheels and tires	<ul style="list-style-type: none"> • Check for damage. • Check tire condition and tread depth. • Check air pressure. • Correct if necessary. 	6-13, 6-16
Brake and shift pedals	<ul style="list-style-type: none"> • Make sure that operation is smooth. • Lubricate pedal pivoting points if necessary. 	6-24
Brake and clutch levers	<ul style="list-style-type: none"> • Make sure that operation is smooth. • Lubricate lever pivoting points if necessary. 	6-24
Sidestand	<ul style="list-style-type: none"> • Make sure that operation is smooth. • Lubricate pivot if necessary. 	6-25
Chassis fasteners	<ul style="list-style-type: none"> • Make sure that all nuts, bolts and screws are properly tightened. • Tighten if necessary. 	—
Instruments, lights, signals and switches	<ul style="list-style-type: none"> • Check operation. • Correct if necessary. 	—
Sidestand switch	<ul style="list-style-type: none"> • Check operation of ignition circuit cut-off system. • If system is defective, have Yamaha dealer check vehicle. 	3-11

OPERATION AND IMPORTANT RIDING POINTS

EAU15950
EWA10270

WARNING

- Become thoroughly familiar with all operating controls and their functions before riding. Consult a Yamaha dealer regarding any control or function that you do not thoroughly understand.
- Never start the engine or operate it in a closed area for any length of time. Exhaust fumes are poisonous, and inhaling them can cause loss of consciousness and death within a short time. Always make sure that there is adequate ventilation.
- Before starting out, make sure that the sidestand is up. If the sidestand is not raised completely, it could contact the ground and distract the operator, resulting in a possible loss of control.

Starting a cold engine

In order for the ignition circuit cut-off system to enable starting, one of the following conditions must be met:

- The transmission is in the neutral position.
- The transmission is in gear with the clutch lever pulled and the sidestand up.

EAU16060

WARNING

- Before starting the engine, check the function of the ignition circuit cut-off system according to the procedure described on page 3-11.
- Never ride with the sidestand down.

EWA10290

1. Turn the fuel cock lever to “ON”.
2. Turn the key to “ON” and make sure that the engine stop switch is set to “○”.
3. Shift the transmission into the neutral position.

NOTE:

When the transmission is in the neutral position, the neutral indicator light should be on, otherwise have a Yamaha dealer check the electrical circuit.

4. Turn the starter (choke) on and completely close the throttle. (See page 3-8.)
5. Start the engine by pushing the start switch.

NOTE:

If the engine fails to start, release the start switch, wait a few seconds, and then try again. Each starting attempt should be as short as possible to preserve the battery. Do not crank the engine more than 10 seconds on any one attempt.

6. After starting the engine, move the starter (choke) back halfway.

ECA11040

CAUTION:

For maximum engine life, never accelerate hard when the engine is

OPERATION AND IMPORTANT RIDING POINTS

cold!

7. When the engine is warm, turn the starter (choke) off.

NOTE:

The engine is warm when it responds normally to the throttle with the starter (choke) turned off.

EAU16640

Starting a warm engine

Follow the same procedure as for starting a cold engine with the exception that the starter (choke) is not required when the engine is warm.

EAU16671

Shifting

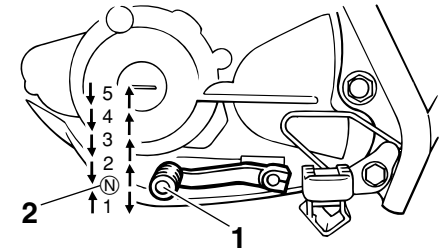

1. Shift pedal
2. Neutral position

Shifting gears lets you control the amount of engine power available for starting off, accelerating, climbing hills, etc.

The gear positions are shown in the illustration.

NOTE:

To shift the transmission into the neutral position, press the shift pedal down repeatedly until it reaches the end of its travel, and then slightly raise it.

OPERATION AND IMPORTANT RIDING POINTS

ECA10260

CAUTION:

- Even with the transmission in the neutral position, do not coast for long periods of time with the engine off, and do not tow the motorcycle for long distances. The transmission is properly lubricated only when the engine is running. Inadequate lubrication may damage the transmission.
- Always use the clutch while changing gears to avoid damaging the engine, transmission, and drive train, which are not designed to withstand the shock of forced shifting.

EAU32810

Recommended shift points (for Switzerland only)

The recommended shift points during acceleration are shown in the table below.

Shift up points:

- 1st → 2nd: 23 km/h (14 mi/h)
- 2nd → 3rd: 36 km/h (22 mi/h)
- 3rd → 4th: 50 km/h (31 mi/h)
- 4th → 5th: 60 km/h (37 mi/h)

NOTE:

When shifting down two gears at a time, reduce the speed accordingly [e.g., down to 35 km/h (22 mi/h) when shifting from 4th to 2nd gear].

EAU16800

Tips for reducing fuel consumption

Fuel consumption depends largely on your riding style. Consider the following tips to reduce fuel consumption:

- Turn the starter (choke) off as soon as possible.
- Shift up swiftly, and avoid high engine speeds during acceleration.
- Do not rev the engine while shifting down, and avoid high engine speeds with no load on the engine.
- Turn the engine off instead of letting it idle for an extended length of time (e.g., in traffic jams, at traffic lights or at railroad crossings).

OPERATION AND IMPORTANT RIDING POINTS

Engine break-in

EAU16830

There is never a more important period in the life of your engine than the period between 0 and 1000 km (600 mi). For this reason, you should read the following material carefully.

Since the engine is brand new, do not put an excessive load on it for the first 1000 km (600 mi). The various parts in the engine wear and polish themselves to the correct operating clearances. During this period, prolonged full-throttle operation or any condition that might result in engine overheating must be avoided.

EAU16990

0–500 km (0–300 mi)

Avoid prolonged operation above 1/3 throttle.

500–1000 km (300–600 mi)

Avoid prolonged operation above 1/2 throttle.

ECA11500

CAUTION:

After 1000 km (600 mi) of operation,

the engine oil must be changed, and the oil filter element and the oil strainer cleaned.

1000 km (600 mi) and beyond

The vehicle can now be operated normally.

ECA10270

CAUTION:

If any engine trouble should occur during the engine break-in period, immediately have a Yamaha dealer check the vehicle.

EAU17170

Parking

When parking, stop the engine, remove the key from the main switch, and then turn the fuel cock lever to “OFF”.

EWA10310

WARNING

- **Since the engine and exhaust system can become very hot, park in a place where pedestrians or children are not likely to touch them.**
- **Do not park on a slope or on soft ground, otherwise the vehicle may overturn.**

PERIODIC MAINTENANCE AND MINOR REPAIR

EAU17240

Safety is an obligation of the owner. Periodic inspection, adjustment and lubrication will keep your vehicle in the safest and most efficient condition possible. The most important points of inspection, adjustment, and lubrication are explained on the following pages. The intervals given in the periodic maintenance and lubrication chart should be simply considered as a general guide under normal riding conditions. However, DEPENDING ON THE WEATHER, TERRAIN, GEOGRAPHICAL LOCATION, AND INDIVIDUAL USE, THE MAINTENANCE INTERVALS MAY NEED TO BE SHORTENED.

EWA10320

⚠ WARNING

If you are not familiar with maintenance work, have a Yamaha dealer do it for you.

EAU17340

Owner's tool kit

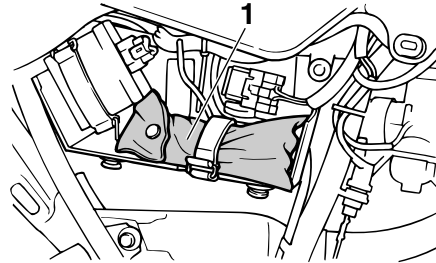

1. Owner's tool kit

The owner's tool kit is located behind panel B. (See page 6-5.)

The service information included in this manual and the tools provided in the owner's tool kit are intended to assist you in the performance of preventive maintenance and minor repairs. However, additional tools such as a torque wrench may be necessary to perform certain maintenance work correctly.

NOTE:

If you do not have the tools or experience required for a particular job, have a Yamaha dealer perform it for you.

EWA10350

⚠ WARNING

Modifications not approved by Yamaha may cause loss of performance and render the vehicle unsafe for use. Consult a Yamaha dealer before attempting any changes.

PERIODIC MAINTENANCE AND MINOR REPAIR

EAU17710

Periodic maintenance and lubrication chart

NOTE:

- The annual checks must be performed every year, except if a kilometer-based maintenance is performed instead.
- From 30000 km, repeat the maintenance intervals starting from 6000 km.
- Items marked with an asterisk should be performed by a Yamaha dealer as they require special tools, data and technical skills.

NO.	ITEM	CHECK OR MAINTENANCE JOB	ODOMETER READING (× 1000 km)					ANNUAL CHECK
			1	6	12	18	24	
1	* Fuel line	<ul style="list-style-type: none"> ● Check fuel hoses for cracks or damage. 		√	√	√	√	√
2	Spark plug	<ul style="list-style-type: none"> ● Check condition. ● Clean and regap. 		√		√		
		<ul style="list-style-type: none"> ● Replace. 			√		√	
3	* Valves	<ul style="list-style-type: none"> ● Check valve clearance. ● Adjust. 		√	√	√	√	
4	Air filter element	<ul style="list-style-type: none"> ● Clean. 		√		√		
		<ul style="list-style-type: none"> ● Replace. 			√		√	
5	Clutch	<ul style="list-style-type: none"> ● Check operation. ● Adjust. 	√	√	√	√	√	
6	* Front brake	<ul style="list-style-type: none"> ● Check operation, fluid level and vehicle for fluid leakage. 	√	√	√	√	√	√
		<ul style="list-style-type: none"> ● Replace brake pads. 	Whenever worn to the limit					
7	* Rear brake	<ul style="list-style-type: none"> ● Check operation and adjust brake pedal free play. 	√	√	√	√	√	√
		<ul style="list-style-type: none"> ● Replace brake shoes. 	Whenever worn to the limit					
8	* Brake hose	<ul style="list-style-type: none"> ● Check for cracks or damage. 		√	√	√	√	√
		<ul style="list-style-type: none"> ● Replace. 	Every 4 years					
9	* Wheels	<ul style="list-style-type: none"> ● Check runout, spoke tightness and for damage. ● Tighten spokes if necessary. 		√	√	√	√	

PERIODIC MAINTENANCE AND MINOR REPAIR

NO.	ITEM	CHECK OR MAINTENANCE JOB	ODOMETER READING (× 1000 km)					ANNUAL CHECK
			1	6	12	18	24	
10	* Tires	<ul style="list-style-type: none"> • Check tread depth and for damage. • Replace if necessary. • Check air pressure. • Correct if necessary. 		✓	✓	✓	✓	✓
11	* Wheel bearings	<ul style="list-style-type: none"> • Check bearing for looseness or damage. 		✓	✓	✓	✓	
12	* Swingarm	<ul style="list-style-type: none"> • Check operation and for excessive play. • Lubricate with lithium-soap-based grease. 		✓	✓	✓	✓	
13	Drive chain	<ul style="list-style-type: none"> • Check chain slack. • Make sure that the rear wheel is properly aligned. • Clean and lubricate. 	Every 24000 km					
14	* Steering bearings	<ul style="list-style-type: none"> • Check bearing play and steering for roughness. • Lubricate with lithium-soap-based grease. 	✓	✓	✓	✓	✓	
15	* Chassis fasteners	<ul style="list-style-type: none"> • Make sure that all nuts, bolts and screws are properly tightened. 		✓	✓	✓	✓	✓
16	Sidestand	<ul style="list-style-type: none"> • Check operation. • Lubricate. 		✓	✓	✓	✓	✓
17	* Sidestand switch	<ul style="list-style-type: none"> • Check operation. 	✓	✓	✓	✓	✓	✓
18	* Front fork	<ul style="list-style-type: none"> • Check operation and for oil leakage. 		✓	✓	✓	✓	
19	* Shock absorber assembly	<ul style="list-style-type: none"> • Check operation and shock absorber for oil leakage. 		✓	✓	✓	✓	
20	* Rear suspension relay arm and connecting arm pivoting points	<ul style="list-style-type: none"> • Check operation. • Lubricate with lithium-soap-based grease. 		✓	✓	✓	✓	
21	* Carburetor	<ul style="list-style-type: none"> • Check starter (choke) operation. • Adjust engine idling speed. 	✓	✓	✓	✓	✓	✓
22	Engine oil	<ul style="list-style-type: none"> • Change. • Check oil level and vehicle for oil leakage. 	✓	✓	✓	✓	✓	✓
23	Engine oil filter element	<ul style="list-style-type: none"> • Clean. 	✓		✓		✓	
24	* Engine oil strainer	<ul style="list-style-type: none"> • Clean. 	✓					

PERIODIC MAINTENANCE AND MINOR REPAIR

NO.	ITEM	CHECK OR MAINTENANCE JOB	ODOMETER READING (× 1000 km)					ANNUAL CHECK
			1	6	12	18	24	
25	* Front and rear brake switches	<ul style="list-style-type: none"> • Check operation. 	√	√	√	√	√	√
26	Moving parts and cables	<ul style="list-style-type: none"> • Lubricate. 		√	√	√	√	√
27	* Throttle grip housing and cable	<ul style="list-style-type: none"> • Check operation and free play. • Adjust the throttle cable free play if necessary. • Lubricate the throttle grip housing and cable. 		√	√	√	√	√
28	* Lights, signals and switches	<ul style="list-style-type: none"> • Check operation. • Adjust headlight beam. 	√	√	√	√	√	√

EAU18660

NOTE: _____

- The air filter needs more frequent service if you are riding in unusually wet or dusty areas.
- Hydraulic brake service
 - Regularly check and, if necessary, correct the brake fluid level.
 - Every two years replace the internal components of the brake master cylinder and caliper, and change the brake fluid.
 - Replace the brake hoses every four years and if cracked or damaged.

PERIODIC MAINTENANCE AND MINOR REPAIR

EAU18771

Removing and installing panels

The panels shown need to be removed to perform some of the maintenance jobs described in this chapter. Refer to this section each time a panel needs to be removed and installed.

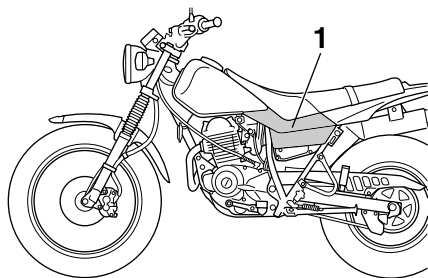

1. Panel A

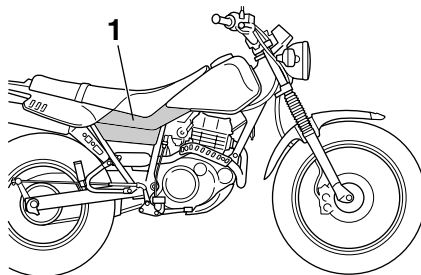

1. Panel B

EAU32451

Panel A

To remove the panel

Remove the screws, and then pull the panel out at the area shown.

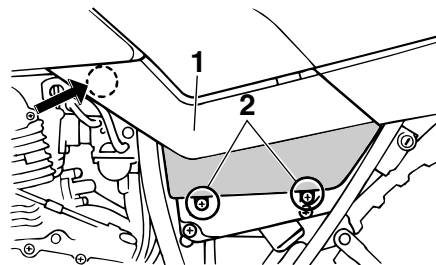

1. Panel A
2. Screw

To install the panel

Place the panel in the original position, and then install the screws.

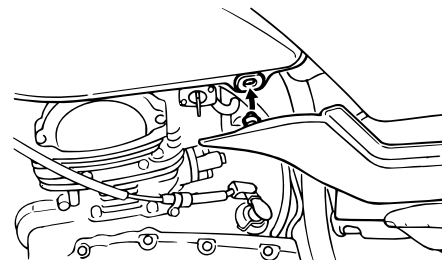

Panel B

To remove the panel

Pull the panel off as shown.

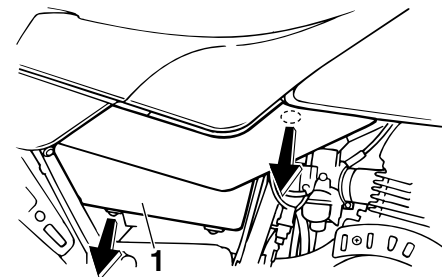

1. Panel B

PERIODIC MAINTENANCE AND MINOR REPAIR

To install the panel

Place the panel in the original position.

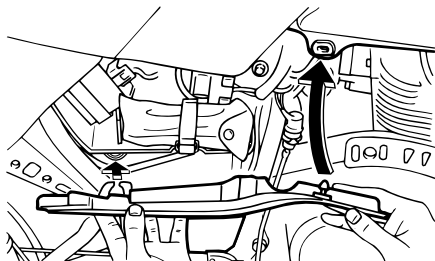

EAU19602

Checking the spark plug

The spark plug is an important engine component, which is easy to check. Since heat and deposits will cause any spark plug to slowly erode, the spark plug should be removed and checked in accordance with the periodic maintenance and lubrication chart. In addition, the condition of the spark plug can reveal the condition of the engine.

To remove the spark plug

1. Remove the spark plug cap.

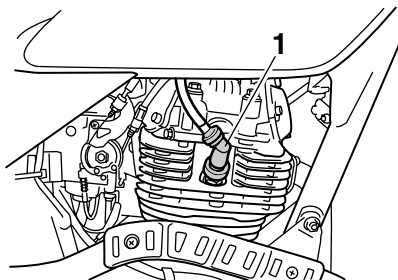

1. Spark plug cap

2. Remove the spark plug as shown, with the spark plug wrench included in the owner's tool kit.

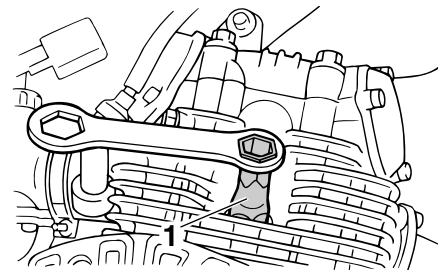

1. Spark plug wrench

To check the spark plug

1. Check that the porcelain insulator around the center electrode of the spark plug is a medium-to-light tan (the ideal color when the vehicle is ridden normally).

NOTE:

If the spark plug shows a distinctly different color, the engine could be defective. Do not attempt to diagnose such problems yourself. Instead, have a Yamaha dealer check the vehicle.

2. Check the spark plug for electrode erosion and excessive carbon or other deposits, and replace it if

PERIODIC MAINTENANCE AND MINOR REPAIR

necessary.

Specified spark plug:
NGK/DR8EA

To install the spark plug

1. Measure the spark plug gap with a wire thickness gauge and, if necessary, adjust the gap to specification.

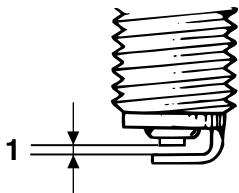

1. Spark plug gap

Spark plug gap:
0.6–0.7 mm (0.024–0.028 in)

2. Clean the surface of the spark plug gasket and its mating surface, and then wipe off any grime from the spark plug threads.

3. Install the spark plug with the spark plug wrench, and then tighten it to the specified torque.

Tightening torque:

Spark plug:
17.5 Nm (1.75 m·kgf,
12.7 ft·lbf)

NOTE:

If a torque wrench is not available when installing a spark plug, a good estimate of the correct torque is 1/4–1/2 turn past finger tight. However, the spark plug should be tightened to the specified torque as soon as possible.

4. Install the spark plug cap.

EAU19792

Engine oil and oil filter element

The engine oil level should be checked before each ride. In addition, the oil must be changed and the oil filter element cleaned at the intervals specified in the periodic maintenance and lubrication chart.

To check the engine oil level

1. Place the vehicle on a level surface and hold it in an upright position.

NOTE:

Make sure that the vehicle is positioned straight up when checking the oil level. A slight tilt to the side can result in a false reading.

2. Start the engine, warm it up for several minutes, and then turn it off.
3. Wait a few minutes until the oil settles, and then check the oil level through the check window located at the bottom-right side of the

PERIODIC MAINTENANCE AND MINOR REPAIR

crankcase.

NOTE: _____
The engine oil should be between the minimum and maximum level marks.

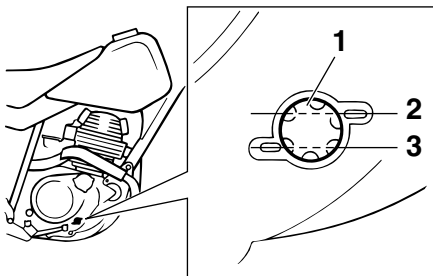

1. Engine oil level check window
2. Maximum level mark
3. Minimum level mark

4. If the engine oil is below the minimum level mark, add sufficient oil of the recommended type to raise it to the correct level.

To change the engine oil (with or without oil filter element cleaning)

1. Start the engine, warm it up for several minutes, and then turn it off.
2. Place an oil pan under the engine

to collect the used oil.

3. Remove the engine oil filler cap and drain bolt to drain the oil from the crankcase.

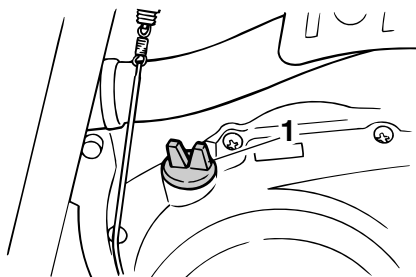

1. Engine oil filler cap

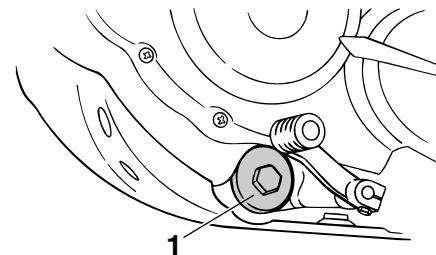

1. Engine oil drain bolt

ECA11000

CAUTION: _____

When removing the engine oil drain bolt, the O-ring, compression spring, and oil strainer will fall out. Take care not to lose these parts.

PERIODIC MAINTENANCE AND MINOR REPAIR

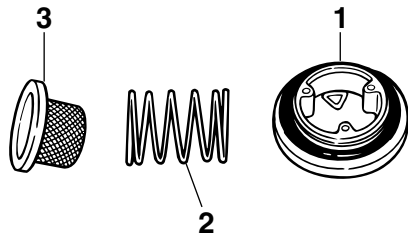

1. O-ring
2. Compression spring
3. Strainer

NOTE: _____

Skip steps 4–9 if the oil filter element is not being cleaned.

4. Remove the oil filter element drain bolt to drain the oil from the oil filter element.

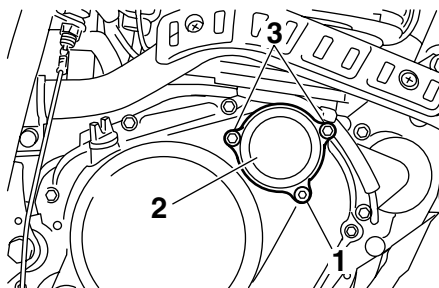

5. Remove the oil filter element cover by removing the bolts.
6. Remove the oil filter element and O-rings.

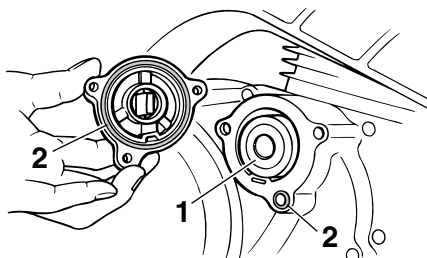

1. Oil filter element
2. O-ring

7. Check the O-ring for damage and replace it if necessary.
8. Clean the oil filter element with solvent, and then install it.

NOTE: _____
Check the oil filter element for damage and replace it if necessary.

9. Install the oil filter element cover by installing the bolts and the drain bolt, then tightening them to the specified torques.

Tightening torques:

Oil filter element cover bolt:

10 Nm (1.0m·kgf,
7.2 ft·lbf)

Oil filter element drain bolt:

10 Nm (1.0m·kgf,
7.2 ft·lbf)

NOTE: _____
Make sure that the O-rings are properly seated.

10. Clean the oil strainer with solvent, and then check it for damage and replace it if necessary.

PERIODIC MAINTENANCE AND MINOR REPAIR

EAU20830

11. Install the oil strainer, compression spring, O-ring and engine oil drain bolt, and then tighten the drain bolt to the specified torque.

Tightening torque:

Engine oil drain bolt:
43 Nm (4.3 m·kgf, 31.1 ft·lbf)

12. Add the specified amount of the recommended engine oil, and then install and tighten the oil filler cap.

Recommended engine oil:
See page 8-1.

Oil quantity:

Without oil filter element removal:
1.00 L (1.06 US qt)
(0.88 Imp.qt)

With oil filter element removal:
1.10 L (1.16 US qt)
(0.97 Imp.qt)

ECA11620

CAUTION:

- In order to prevent clutch slippage (since the engine oil also lubricates the clutch), do not mix any chemical additives. Do

not use oils with a diesel specification of “CD” or oils of a higher quality than specified. In addition, do not use oils labeled “ENERGY CONSERVING II” or higher.

- Make sure that no foreign material enters the crankcase.

13. Start the engine, and then let it idle for several minutes while checking it for oil leakage. If oil is leaking, immediately turn the engine off and check for the cause.
14. Turn the engine off, and then check the oil level and correct it if necessary.

Cleaning the air filter element and check hose

The air filter element should be cleaned at the intervals specified in the periodic maintenance and lubrication chart. Clean the air filter element more frequently if you are riding in unusually wet or dusty areas. In addition, the air filter check hose must be frequently checked and cleaned if necessary.

To clean the air filter element

1. Remove panel A. (See page 6-5.)
2. Remove the air filter case cover by removing the screws.

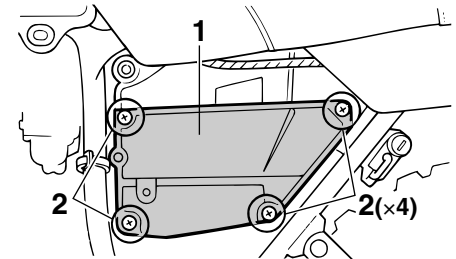

1. Air filter case cover
2. Screw
3. Pull the air filter element out.

PERIODIC MAINTENANCE AND MINOR REPAIR

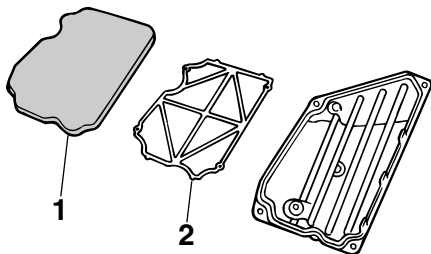

1. Sponge material
2. Air filter element frame

4. Remove the sponge material from the air filter element frame, clean it with solvent, and then squeeze the remaining solvent out.

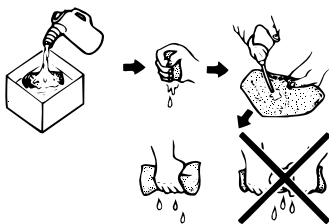

5. Apply oil of the recommended type to the entire surface of the sponge

material, and then squeeze the excess oil out.

NOTE: _____
The sponge material should be wet but not dripping.

Recommended oil:
Engine oil

6. Pull the sponge material over the air filter element frame.
7. Insert the element into the air filter case.

ECA10480

CAUTION: _____

- Make sure that the air filter element is properly seated in the air filter case.
- The engine should never be operated without the air filter element installed, otherwise the piston(s) and/or cylinder(s) may become excessively worn.

8. Install the air filter case cover by installing the screws.
9. Install the panel.

To clean the air filter check hose

1. Check the hose at the bottom of the air filter case for accumulated dirt or water.

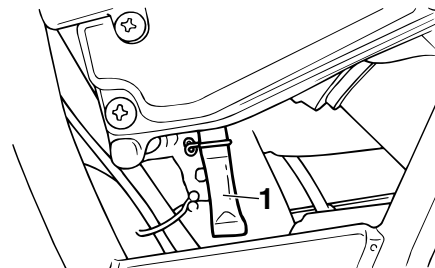

1. Air filter check hose
2. If dirt or water is visible, remove the hose, clean it, and then install it.

PERIODIC MAINTENANCE AND MINOR REPAIR

EAU21280

Adjusting the carburetor

The carburetor is an important part of the engine and requires very sophisticated adjustment. Therefore, most carburetor adjustments should be left to a Yamaha dealer, who has the necessary professional knowledge and experience. The adjustment described in the following section, however, may be serviced by the owner as part of routine maintenance.

ECA10550

CAUTION:

The carburetor has been set and extensively tested at the Yamaha factory. Changing these settings without sufficient technical knowledge may result in poor performance of or damage to the engine.

EAU21340

Adjusting the engine idling speed

The engine idling speed must be checked and, if necessary, adjusted as follows at the intervals specified in the periodic maintenance and lubrication chart.

The engine should be warm before making this adjustment.

NOTE:

- The engine is warm when it quickly responds to the throttle.
- A diagnostic tachometer is needed to make this adjustment.

1. Attach the tachometer to the spark plug lead.
2. Check the engine idling speed and, if necessary, adjust it to specification by turning the throttle stop screw. To increase the engine idling speed, turn the screw in direction (a). To decrease the engine idling speed, turn the screw in direction (b).

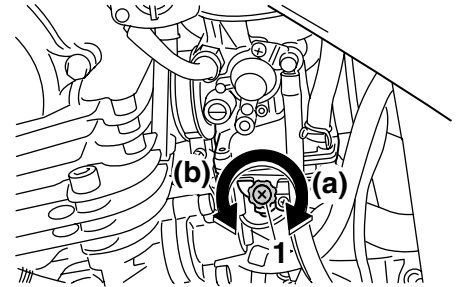

1. Throttle stop screw

Engine idling speed:
1450–1650 r/min

NOTE:

If the specified idling speed cannot be obtained as described above, have a Yamaha dealer make the adjustment.

PERIODIC MAINTENANCE AND MINOR REPAIR

EAU21380

Adjusting the throttle cable free play

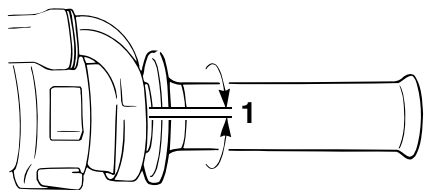

1. Throttle cable free play

The throttle cable free play should measure 3.0–5.0 mm (0.12–0.20 in) at the throttle grip. Periodically check the throttle cable free play and, if necessary, have a Yamaha dealer adjust it.

6

EAU21400

Adjusting the valve clearance

The valve clearance changes with use, resulting in improper air-fuel mixture and/or engine noise. To prevent this from occurring, the valve clearance must be adjusted by a Yamaha dealer at the intervals specified in the periodic maintenance and lubrication chart.

EAU21581

Tires

To maximize the performance, durability, and safe operation of your motorcycle, note the following points regarding the specified tires.

Tire air pressure

The tire air pressure should be checked and, if necessary, adjusted before each ride.

EWA10500

WARNING

- The tire air pressure must be checked and adjusted on cold tires (i.e., when the temperature of the tires equals the ambient temperature).
- The tire air pressure must be adjusted in accordance with the riding speed and with the total weight of rider, passenger, cargo, and accessories approved for this model.

PERIODIC MAINTENANCE AND MINOR REPAIR

Tire air pressure (measured on cold tires):

0–90 kg (0–198 lb) :

Front:

150 kPa (22 psi) (1.50 kgf/cm²)

Rear:

150 kPa (22 psi) (1.50 kgf/cm²)

90–180 kg (198–397 lb) :

Front:

150 kPa (22 psi) (1.50 kgf/cm²)

Rear:

175 kPa (25 psi) (1.75 kgf/cm²)

Maximum load*:

180 kg (397 lb)

* Total weight of rider, passenger, cargo and accessories

EWA11200

WARNING

Because loading has an enormous impact on the handling, braking, performance and safety characteristics of your vehicle, you should keep the following precautions in mind.

- **NEVER OVERLOAD THE VEHICLE!** Operation of an overloaded vehicle may result in tire

damage, loss of control, or severe injury. Make sure that the total weight of rider, passenger, cargo, and accessories does not exceed the specified maximum load for the vehicle.

- Do not carry along loosely packed items, which can shift during a ride.
- Securely pack the heaviest items close to the center of the vehicle and distribute the weight evenly on both sides.
- Adjust the tire air pressure with regard to the load.
- Check the tire condition and air pressure before each ride.

Tire inspection

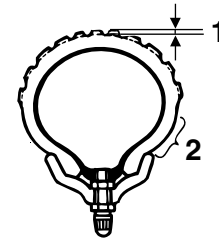

1. Tire tread depth
2. Tire sidewall

The tires must be checked before each ride. If the center tread depth reaches the specified limit, if the tire has a nail or glass fragments in it, or if the sidewall is cracked, have a Yamaha dealer replace the tire immediately.

Minimum tire tread depth (front and rear):
1.6 mm (0.06 in)

NOTE:

The tire tread depth limits may differ from country to country. Always comply with the local regulations.

PERIODIC MAINTENANCE AND MINOR REPAIR

Tire information

This motorcycle is equipped with tube tires.

EWA10460

WARNING

- The front and rear tires should be of the same make and design, otherwise the handling characteristics of the vehicle cannot be guaranteed.
- After extensive tests, only the tires listed below have been approved for this model by Yamaha Motor Co., Ltd.

Front tire:

Size:

130/80-18M/C 66P

Manufacturer/model:

BRIDGESTONE/TW-203

Rear tire:

Size:

180/80-14M/C 78P

Manufacturer/model:

BRIDGESTONE/TW-204

EWA10570

WARNING

- Have a Yamaha dealer replace excessively worn tires. Besides being illegal, operating the motorcycle with excessively worn tires decreases riding stability and can lead to loss of control.
- The replacement of all wheel- and brake-related parts, including the tires, should be left to a Yamaha dealer, who has the necessary professional knowledge and experience.
- It is not recommended to patch a punctured tube. If unavoi-

able, however, patch the tube very carefully and replace it as soon as possible with a high-quality product.

EAU21940

Spoke wheels

To maximize the performance, durability, and safe operation of your motorcycle, note the following points regarding the specified wheels.

- The wheel rims should be checked for cracks, bends or warpage, and the spokes for looseness or damage before each ride. If any damage is found, have a Yamaha dealer replace the wheel. Do not attempt even the smallest repair to the wheel. A deformed or cracked wheel must be replaced.
- The wheel should be balanced whenever either the tire or wheel has been changed or replaced. An unbalanced wheel can result in poor performance, adverse handling characteristics, and a shortened tire life.
- Ride at moderate speeds after changing a tire since the tire surface must first be “broken in” for it to develop its optimal characteristics.

EAU22040

Adjusting the clutch lever free play

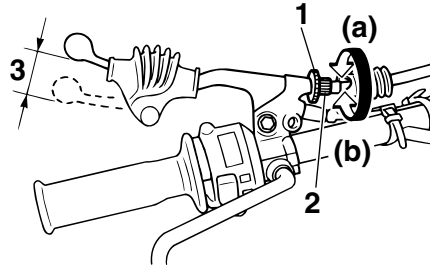

1. Locknut (clutch lever)
2. Adjusting bolt
3. Clutch lever free play

The clutch lever free play should measure 10.0–15.0 mm (0.39–0.59 in) as shown. Periodically check the clutch lever free play and, if necessary, adjust it as follows.

1. Loosen the locknut at the clutch lever.
2. To increase the clutch lever free play, turn the adjusting bolt in direction (a). To decrease the clutch lever free play, turn the adjusting bolt in direction (b).

3. If the specified clutch lever free play could be obtained as described above, tighten the locknut and skip the rest of the procedure, otherwise proceed as follows.
4. Fully turn the adjusting bolt at the clutch lever in direction (a) to loosen the clutch cable.
5. Loosen the locknut at the crankcase.

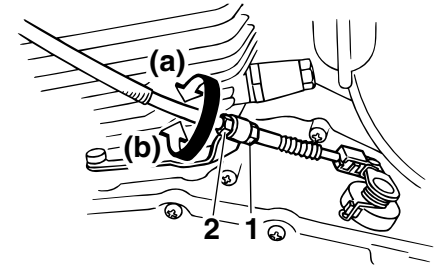

1. Locknut (crankcase)
2. Adjusting nut

6. To increase the clutch lever free play, turn the adjusting nut in direction (a). To decrease the clutch lever free play, turn the adjusting nut in direction (b).

PERIODIC MAINTENANCE AND MINOR REPAIR

7. Tighten the locknut at the clutch lever and the crankcase.

Adjusting the brake lever free play

EAU22092

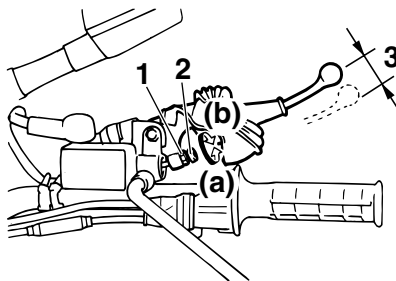

1. Locknut
2. Brake lever free play adjusting screw
3. Brake lever free play

The brake lever free play should measure 5.0–8.0 mm (0.20–0.31 in) as shown. Periodically check the brake lever free play and, if necessary, adjust it as follows.

1. Loosen the locknut at the brake lever.
2. To increase the brake lever free play, turn the adjusting screw in direction (a). To decrease the brake lever free play, turn the adjusting screw in direction (b).

3. Tighten the locknut.

EWA10630

! WARNING

- After adjusting the brake lever free play, check the free play and make sure that the brake is working properly.
- A soft or spongy feeling in the brake lever can indicate the presence of air in the hydraulic system. If there is air in the hydraulic system, have a Yamaha dealer bleed the system before operating the motorcycle. Air in the hydraulic system will diminish the braking performance, which may result in loss of control and an accident.

PERIODIC MAINTENANCE AND MINOR REPAIR

Adjusting the brake pedal position and free play

EAU22191

EWA10670



WARNING

It is advisable to have a Yamaha dealer make these adjustments.

Brake pedal position

The top of the brake pedal should be positioned approximately 30.0 mm (1.18 in) below the top of the footrest. Periodically check the brake pedal position and, if necessary, adjust it as follows.

1. Loosen the locknut at the brake pedal.
2. To raise the brake pedal, turn the adjusting bolt in direction (a). To lower the brake pedal, turn the adjusting bolt in direction (b).

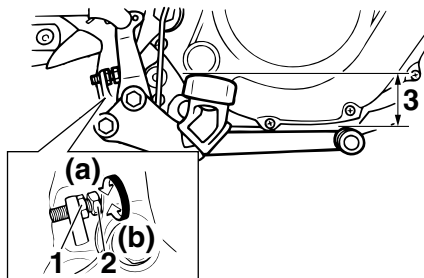

1. Locknut
2. Brake pedal position adjusting bolt
3. Brake pedal position

3. Tighten the locknut.



WARNING

After adjusting the brake pedal position, the brake pedal free play must be adjusted.

EWA11230

Brake pedal free play

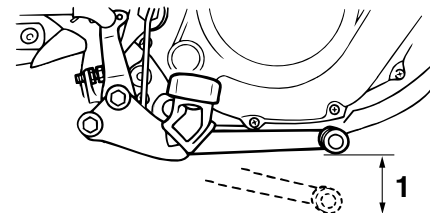

1. Brake pedal free play

The brake pedal free play should measure 20.0–30.0 mm (0.79–1.18 in) as shown. Periodically check the brake pedal free play and, if necessary, adjust it as follows.

To increase the brake pedal free play, turn the adjusting nut at the brake rod in direction (a). To decrease the brake pedal free play, turn the adjusting nut in direction (b).

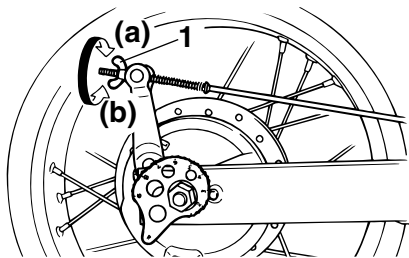

1. Brake pedal free play adjusting nut

EWA10680

⚠ WARNING

- After adjusting the drive chain slack or removing and installing the rear wheel, always check the brake pedal free play.
- If proper adjustment cannot be obtained as described, have a Yamaha dealer make this adjustment.
- After adjusting the brake pedal free play, check the operation of the brake light.

Adjusting the rear brake light switch

EAU22270

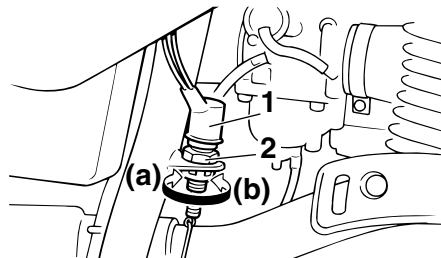

1. Rear brake light switch
2. Rear brake light switch adjusting nut

The rear brake light switch, which is activated by the brake pedal, is properly adjusted when the brake light comes on just before braking takes effect. If necessary, adjust the brake light switch as follows.

Turn the adjusting nut while holding the rear brake light switch in place. To make the brake light come on earlier, turn the adjusting nut in direction (a). To make the brake light come on later, turn the adjusting nut in direction (b).

Checking the front brake pads and rear brake shoes

EAU22380

The front brake pads and the rear brake shoes must be checked for wear at the intervals specified in the periodic maintenance and lubrication chart.

EAU22430

Front brake pads

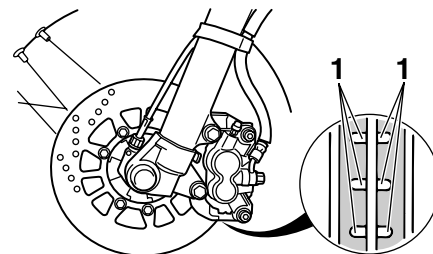

1. Brake pad wear indicator groove

Each front brake pad is provided with wear indicator grooves, which allow you to check the brake pad wear without having to disassemble the brake. To check the brake pad wear, check the wear indicator grooves. If a brake pad has worn to the point that the wear indicator grooves have almost disap-

PERIODIC MAINTENANCE AND MINOR REPAIR

peared, have a Yamaha dealer replace the brake pads as a set.

Rear brake shoes

EAU22540

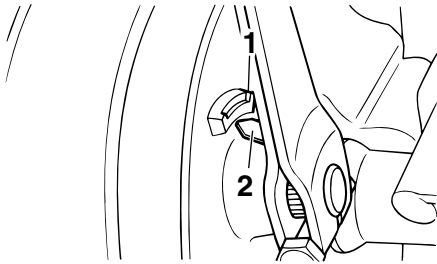

1. Brake shoe wear limit line
2. Brake shoe wear indicator

The rear brake is provided with a wear indicator, which allows you to check the brake shoe wear without having to disassemble the brake. To check the brake shoe wear, check the position of the wear indicator while applying the brake. If a brake shoe has worn to the point that the wear indicator reaches the wear limit line, have a Yamaha dealer replace the brake shoes as a set.

Checking the brake fluid level

EAU32341

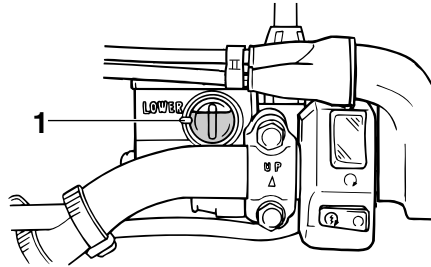

1. Minimum level mark

Insufficient brake fluid may allow air to enter the brake system, possibly causing it to become ineffective.

Before riding, check that the brake fluid is above the minimum level mark and replenish if necessary. A low brake fluid level may indicate worn brake pads and/or brake system leakage. If the brake fluid level is low, be sure to check the brake pads for wear and the brake system for leakage.

Observe these precautions:

- When checking the fluid level, make sure that the top of the mas-

ter cylinder is level by turning the handlebars.

- Use only the recommended quality brake fluid, otherwise the rubber seals may deteriorate, causing leakage and poor braking performance.

Recommended brake fluid:
DOT 4

- Refill with the same type of brake fluid. Mixing fluids may result in a harmful chemical reaction and lead to poor braking performance.
- Be careful that water does not enter the master cylinder when refilling. Water will significantly lower the boiling point of the fluid and may result in vapor lock.
- Brake fluid may deteriorate painted surfaces or plastic parts. Always clean up spilled fluid immediately.
- As the brake pads wear, it is normal for the brake fluid level to gradually go down. However, if the

PERIODIC MAINTENANCE AND MINOR REPAIR

brake fluid level goes down suddenly, have a Yamaha dealer check the cause.

EAU22720

Changing the brake fluid

Have a Yamaha dealer change the brake fluid at the intervals specified in the NOTE after the periodic maintenance and lubrication chart. In addition, have the oil seals of the brake master cylinder and caliper as well as the brake hose replaced at the intervals listed below or whenever they are damaged or leaking.

- Oil seals: Replace every two years.
- Brake hose: Replace every four years.

EAU22760

Drive chain slack

The drive chain slack should be checked before each ride and adjusted if necessary.

EAU22770

To check the drive chain slack

1. Place the motorcycle on a level surface and hold it in an upright position.

NOTE: _____

When checking and adjusting the drive chain slack, the motorcycle should be positioned straight up and there should be no weight on it.

2. Shift the transmission into the neutral position.
3. Move the rear wheel by pushing the motorcycle to locate the tightest portion of the drive chain, and then measure the drive chain slack as shown.

Drive chain slack:
35.0–60.0 mm (1.38–2.36 in)

PERIODIC MAINTENANCE AND MINOR REPAIR

ECA10570

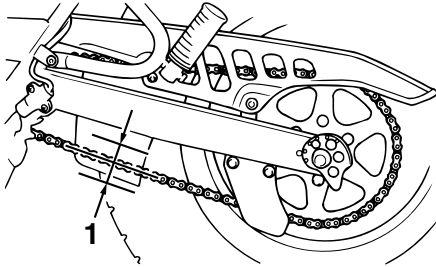

1. Drive chain slack

4. If the drive chain slack is incorrect, adjust it as follows.

EAU22830

To adjust the drive chain slack

1. Loosen the brake pedal free play adjusting nut.

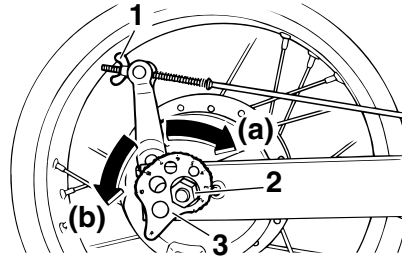

1. Brake pedal free play adjusting nut

2. Axle nut

3. Drive chain slack adjusting plate

2. Loosen the axle nut.

3. To tighten the drive chain, turn the adjusting plate on each side of the swingarm in direction (a). To loosen the drive chain, turn the adjusting plate on each side of the swingarm in direction (b), and then push the rear wheel forward.

NOTE: _____

Make sure that both adjusting plates are in the same position for proper wheel alignment.

CAUTION:

Improper drive chain slack will overload the engine as well as other vital parts of the motorcycle and can lead to chain slippage or breakage. To prevent this from occurring, keep the drive chain slack within the specified limits.

4. Tighten the axle nut to the specified torque.

Tightening torque:

Axle nut:

90 Nm (9.0 m·kgf, 65.1 ft·lbf)

5. Adjust the brake pedal free play. (See page 6-18.)

EWA10660

WARNING

After adjusting the brake pedal free play, check the operation of the brake light.

PERIODIC MAINTENANCE AND MINOR REPAIR

EAU23011

Lubricating the drive chain

The drive chain must be cleaned and lubricated at the intervals specified in the periodic maintenance and lubrication chart, otherwise it will quickly wear out, especially when riding in dusty or wet areas. Service the drive chain as follows.

ECA10580

CAUTION:

The drive chain must be lubricated after washing the motorcycle or riding in the rain.

1. Remove all dirt and mud from the drive chain with a brush or cloth.

NOTE:

For a thorough cleaning, have a Yamaha dealer remove the drive chain and soak it in solvent.

2. Spray Yamaha Chain and Cable Lube or a high-quality spray-type drive chain lubricant on both sides and on the middle of the chain, making sure that all side plates and rollers have been sufficiently

oiled.

EAU23100

Checking and lubricating the cables

The operation of all control cables and the condition of the cables should be checked before each ride, and the cables and cable ends should be lubricated if necessary. If a cable is damaged or does not move smoothly, have a Yamaha dealer check or replace it.

Recommended lubricant:
Engine oil

EWA10720

WARNING

Damage to the outer sheath may interfere with proper cable operation and will cause the inner cable to rust. Replace a damaged cable as soon as possible to prevent unsafe conditions.

PERIODIC MAINTENANCE AND MINOR REPAIR

EAU23110

Checking and lubricating the throttle grip and cable

The operation of the throttle grip should be checked before each ride. In addition, the cable should be lubricated or replaced at the intervals specified in the periodic maintenance chart.

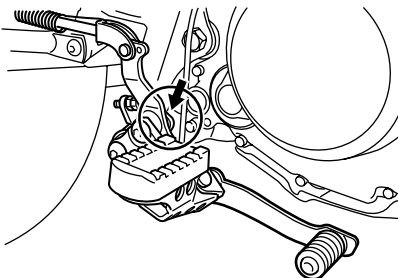

Checking and lubricating the brake and shift pedals

The operation of the brake and shift pedals should be checked before each ride, and the pedal pivots should be lubricated if necessary.

Recommended lubricant:
Lithium-soap-based grease
(all-purpose grease)

EAU23131

Checking and lubricating the brake and clutch levers

The operation of the brake and clutch levers should be checked before each ride, and the lever pivots should be lubricated if necessary.

Recommended lubricant:
Lithium-soap-based grease
(all-purpose grease)

EAU23140

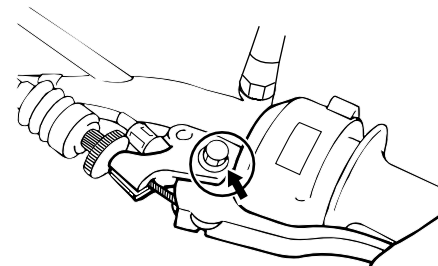

PERIODIC MAINTENANCE AND MINOR REPAIR

EAU23200

Checking and lubricating the sidestand

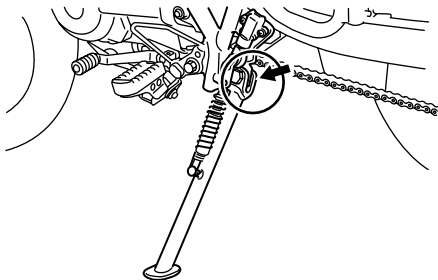

The operation of the sidestand should be checked before each ride, and the sidestand pivot and metal-to-metal contact surfaces should be lubricated if necessary.

EWA10730

WARNING

If the sidestand does not move up and down smoothly, have a Yamaha dealer check or repair it.

Recommended lubricant:
Lithium-soap-based grease
(all-purpose grease)

EAU23250

Lubricating the rear suspension

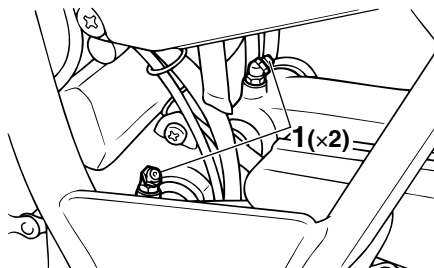

1. Grease nipple

The pivoting points of the rear suspension must be lubricated at the intervals specified in the periodic maintenance and lubrication chart.

Recommended lubricant:
Lithium-soap-based grease

EAU23271

Checking the front fork

The condition and operation of the front fork must be checked as follows at the intervals specified in the periodic maintenance and lubrication chart.

To check the condition

EWA10750

WARNING

Securely support the vehicle so that there is no danger of it falling over.

Check the inner tubes for scratches, damage and excessive oil leakage.

To check the operation

1. Place the vehicle on a level surface and hold it in an upright position.
2. While applying the front brake, push down hard on the handlebars several times to check if the front fork compresses and rebounds smoothly.

PERIODIC MAINTENANCE AND MINOR REPAIR

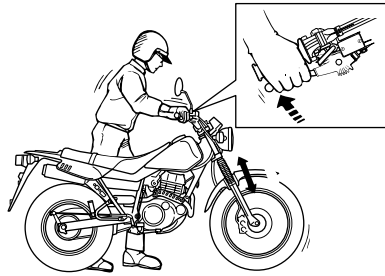

ECA10590

CAUTION:

If any damage is found or the front fork does not operate smoothly, have a Yamaha dealer check or repair it.

EAU23280

Checking the steering

Worn or loose steering bearings may cause danger. Therefore, the operation of the steering must be checked as follows at the intervals specified in the periodic maintenance and lubrication chart.

1. Place a stand under the engine to raise the front wheel off the ground.

EWA10750

! WARNING

Securely support the vehicle so that there is no danger of it falling over.

2. Hold the lower ends of the front fork legs and try to move them forward and backward. If any free play can be felt, have a Yamaha dealer check or repair the steering.

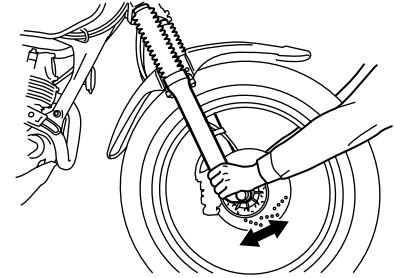

PERIODIC MAINTENANCE AND MINOR REPAIR

EAU23290

Checking the wheel bearings

The front and rear wheel bearings must be checked at the intervals specified in the periodic maintenance and lubrication chart. If there is play in the wheel hub or if the wheel does not turn smoothly, have a Yamaha dealer check the wheel bearings.

EAU23370

Battery

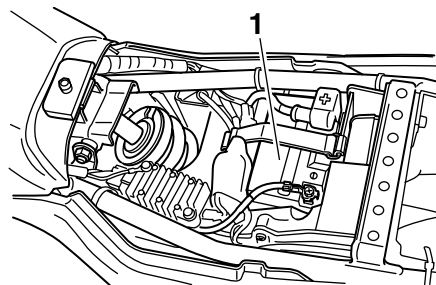

1. Battery

This model is equipped with a sealed-type (MF) battery, which does not require any maintenance. There is no need to check the electrolyte or to add distilled water.

ECA10620

CAUTION:

Never attempt to remove the battery cell seals, as this would permanently damage the battery.

EWA10760

WARNING

- Electrolyte is poisonous and dangerous since it contains sul-

furic acid, which causes severe burns. Avoid any contact with skin, eyes or clothing and always shield your eyes when working near batteries. In case of contact, administer the following FIRST AID.

- **EXTERNAL:** Flush with plenty of water.
- **INTERNAL:** Drink large quantities of water or milk and immediately call a physician.
- **EYES:** Flush with water for 15 minutes and seek prompt medical attention.
- Batteries produce explosive hydrogen gas. Therefore, keep sparks, flames, cigarettes, etc., away from the battery and provide sufficient ventilation when charging it in an enclosed space.
- **KEEP THIS AND ALL BATTERIES OUT OF THE REACH OF CHILDREN.**

PERIODIC MAINTENANCE AND MINOR REPAIR

EAU23500

To charge the battery

Have a Yamaha dealer charge the battery as soon as possible if it seems to have discharged. Keep in mind that the battery tends to discharge more quickly if the vehicle is equipped with optional electrical accessories.

To store the battery

1. If the vehicle will not be used for more than one month, remove the battery, fully charge it, and then place it in a cool, dry place.
2. If the battery will be stored for more than two months, check it at least once a month and fully charge it if necessary.
3. Fully charge the battery before installation.
4. After installation, make sure that the battery leads are properly connected to the battery terminals.

ECA10630

CAUTION:

- Always keep the battery charged. Storing a discharged battery can cause permanent

battery damage.

- To charge a sealed-type (MF) battery, a special (constant-voltage) battery charger is required. Using a conventional battery charger will damage the battery. If you do not have access to a sealed-type (MF) battery charger, have a Yamaha dealer charge your battery.

Replacing the fuse

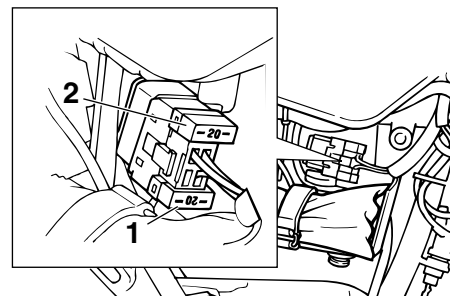

1. Fuse
2. Spare fuse

The fuse holder is located behind panel B. (See page 6-5.)

If the fuse is blown, replace it as follows.

1. Turn the key to "OFF" and turn off all electrical circuits.
2. Remove the blown fuse, and then install a new fuse of the specified amperage.

PERIODIC MAINTENANCE AND MINOR REPAIR

Specified fuse:
20.0 A

ECA10640

CAUTION:

Do not use a fuse of a higher amperage rating than recommended to avoid causing extensive damage to the electrical system and possibly a fire.

3. Turn the key to "ON" and turn on the electrical circuits to check if the devices operate.
4. If the fuse immediately blows again, have a Yamaha dealer check the electrical system.

EAU23792

Replacing the headlight bulb

This model is equipped with a quartz bulb headlight. If the headlight bulb burns out, replace it as follows.

1. Remove the headlight unit by removing the screws.

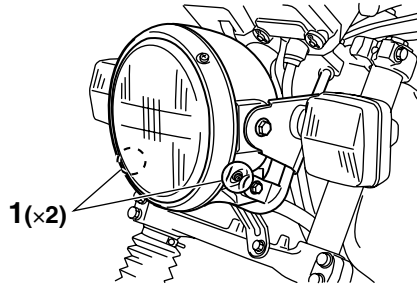

1. Screw

2. Disconnect the headlight coupler, and then remove the bulb cover.

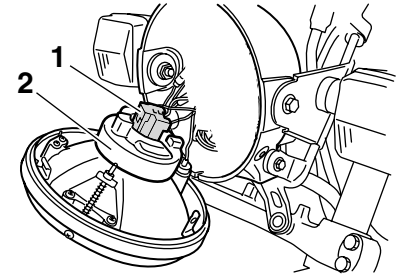

1. Headlight coupler
2. Bulb cover

3. Unhook the headlight bulb holder, and then remove the defective bulb.

PERIODIC MAINTENANCE AND MINOR REPAIR

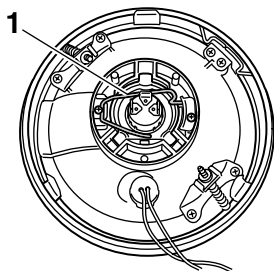

1. Headlight bulb holder

EWA10790

WARNING

Headlight bulbs get very hot. Therefore, keep flammable products away from a lit headlight bulb, and do not touch the bulb until it has cooled down.

4. Place a new headlight bulb into position, and then secure it with the bulb holder.

ECA10660

CAUTION:

Do not touch the glass part of the headlight bulb to keep it free from oil, otherwise the transparency of

the glass, the luminosity of the bulb, and the bulb life will be adversely affected. Thoroughly clean off any dirt and fingerprints on the headlight bulb using a cloth moistened with alcohol or thinner.

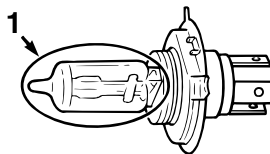

1. Do not touch the glass part of the bulb.
5. Install the headlight bulb cover, and then connect the coupler.

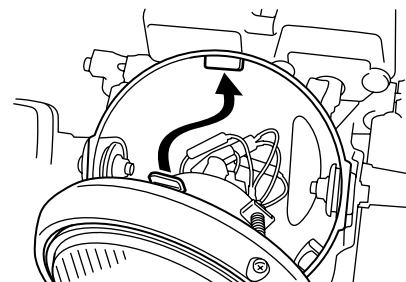

6. Install the headlight unit by installing the screws.
7. Have a Yamaha dealer adjust the headlight beam if necessary.

PERIODIC MAINTENANCE AND MINOR REPAIR

EAU24131

Replacing the tail/brake light bulb

1. Remove the tail/brake light lens by removing the screws.

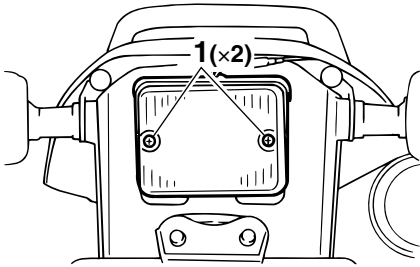

1. Screw
2. Remove the defective bulb by pushing it in and turning it counter-clockwise.

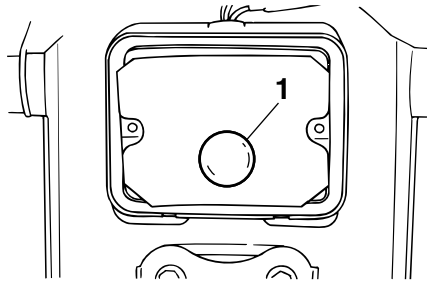

1. Tail/brake light bulb
3. Insert a new bulb into the socket, push it in, and then turn it clockwise until it stops.
4. Install the lens by installing the screws.

CAUTION: _____
Do not overtighten the screws, otherwise the lens may break.

ECA10680

EAU24201

Replacing a turn signal light bulb

1. Remove the turn signal light lens by removing the screw.

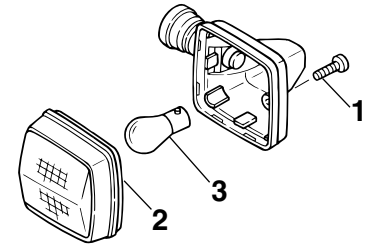

1. Screw
2. Turn signal light lens
3. Bulb
2. Remove the defective bulb by pushing it in and turning it counter-clockwise.
3. Insert a new bulb into the socket, push it in, and then turn it clockwise until it stops.
4. Install the lens by installing the screw.

PERIODIC MAINTENANCE AND MINOR REPAIR

ECA11190

EAU24350

CAUTION:

Do not overtighten the screw, otherwise the lens may break.

Supporting the motorcycle

Since this model is not equipped with a centerstand, follow these precautions when removing the front and rear wheel or performing other maintenance requiring the motorcycle to stand upright. Check that the motorcycle is in a stable and level position before starting any maintenance. A strong wooden box can be placed under the engine for added stability.

To service the front wheel

1. Stabilize the rear of the motorcycle by using a motorcycle stand or, if an additional motorcycle stand is not available, by placing a jack under the frame in front of the rear wheel.
2. Raise the front wheel off the ground by using a motorcycle stand.

To service the rear wheel

Raise the rear wheel off the ground by using a motorcycle stand or, if a motorcycle stand is not available, by placing a jack either under each side of the

frame in front of the rear wheel or under each side of the swingarm.

PERIODIC MAINTENANCE AND MINOR REPAIR

Front wheel

EAU24360

EAU24590

EWA10820

To remove the front wheel

WARNING

- It is advisable to have a Yamaha dealer service the wheel.
- Securely support the motorcycle so that there is no danger of it falling over.

1. Pull outward on the rubber cover at the bottom of the right-side fork leg, and then slide it up along the fork leg.

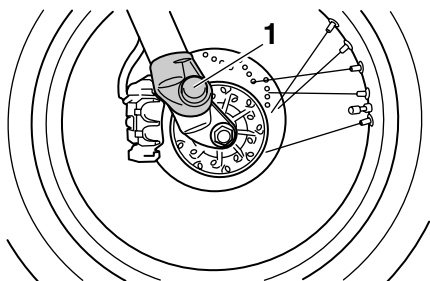

1. Rubber cover

2. Pull outward on the rubber cover at the bottom of the left-side fork leg,

and then pull it off.

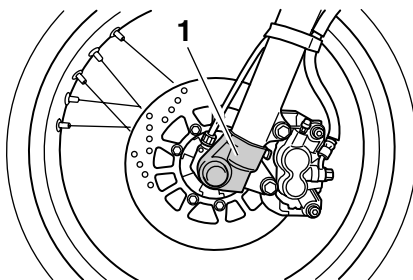

1. Rubber cover

3. Disconnect the speedometer cable from the front wheel.
4. Loosen the axle nut.

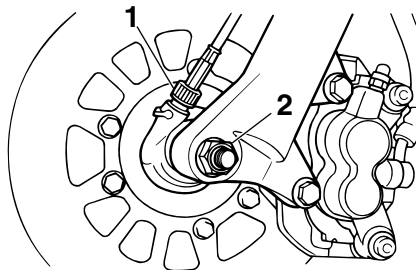

1. Speedometer cable
2. Axle nut

5. Lift the front wheel off the ground

according to the procedure on page 6-32.

6. Remove the axle nut, pull the wheel axle out, and then remove the wheel.

ECA11070

CAUTION:

Do not apply the brake after the wheel has been removed together with the brake disc, otherwise the brake pads will be forced shut.

EAU24991

To install the front wheel

1. Install the speedometer gear unit into the wheel hub so that the projections mesh with the slots.

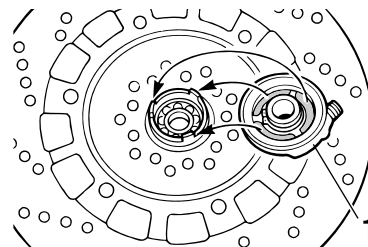

1. Speedometer gear unit

PERIODIC MAINTENANCE AND MINOR REPAIR

- Lift the wheel up between the fork legs.

NOTE: _____

Make sure that there is enough space between the brake pads before inserting the brake disc and that the slot in the speedometer gear unit fits over the retainer on the fork leg.

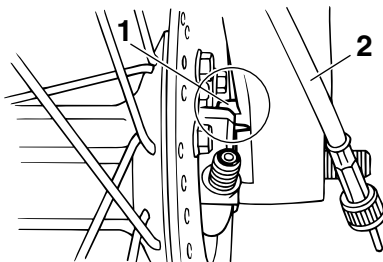

- Retainer
- Speedometer cable

- Insert the wheel axle, and then install the axle nut.
- Lower the front wheel so that it is on the ground.
- Tighten the axle nut to the speci-

fied torque.

Tightening torque:

Axle nut:
90 Nm (9.0 m·kgf, 65.1 ft·lbf)

- Place the rubber cover at the bottom of the right-side fork leg in the original position.
- Install the rubber cover at the bottom of the left-side fork leg.
- Connect the speedometer cable.

Rear wheel

EAU25080

To remove the rear wheel

EAU25420

EWA10820

⚠ WARNING _____

- It is advisable to have a Yamaha dealer service the wheel.
- Securely support the motorcycle so that there is no danger of it falling over.

- Loosen the axle nut.

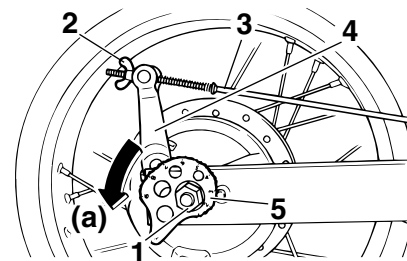

- Axle nut
- Brake pedal free play adjusting nut
- Brake rod
- Brake camshaft lever
- Drive chain slack adjusting plate

- Remove the brake pedal free play

PERIODIC MAINTENANCE AND MINOR REPAIR

adjusting nut, and then disconnect the brake rod from the brake camshaft lever.

3. Turn the drive chain adjusting plate on each side of the swingarm fully in direction (a).
4. Lift the rear wheel off the ground according to the procedure on page 6-32.
5. Remove the axle nut, and then pull the wheel axle out.
6. Push the wheel forward, and then remove the drive chain from the rear sprocket.

NOTE:

The drive chain does not need to be disassembled in order to remove and install the wheel.

7. Remove the wheel.

EAU25761

To install the rear wheel

1. Insert the wheel axle from the left-hand side.

NOTE:

Make sure that the drive chain adjusting plates are installed with the

punched sides facing to the outside and that the slot in the brake shoe plate fits over the retainer on the swingarm.

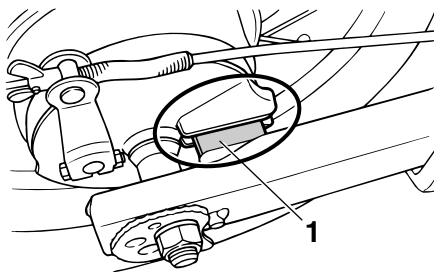

1. Retainer
2. Install the drive chain onto the rear sprocket, and then adjust the drive chain slack. (See page 6-21.)
3. Install the axle nut, and then lower the rear wheel so that it is on the ground.
4. Tighten the axle nut to the specified torque.

Tightening torque:

Axle nut:
90 Nm (9.0 m·kgf, 65.1 ft·lbf)

5. Install the brake rod onto the brake camshaft lever, and then install the brake pedal free play adjusting nut onto the brake rod.
6. Adjust the brake pedal free play. (See page 6-18.)

EWA10660

WARNING

After adjusting the brake pedal free play, check the operation of the brake light.

EAU25850

Troubleshooting

Although Yamaha motorcycles receive a thorough inspection before shipment from the factory, trouble may occur during operation. Any problem in the fuel, compression, or ignition systems, for example, can cause poor starting and loss of power.

The following troubleshooting chart represents a quick and easy procedure for checking these vital systems yourself. However, should your motorcycle require any repair, take it to a Yamaha dealer, whose skilled technicians have the necessary tools, experience, and know-how to service the motorcycle properly.

Use only genuine Yamaha replacement parts. Imitation parts may look like Yamaha parts, but they are often inferior, have a shorter service life and can lead to expensive repair bills.

PERIODIC MAINTENANCE AND MINOR REPAIR

EAU25901

Troubleshooting chart

EWA10840



WARNING

Keep away open flames and do not smoke while checking or working on the fuel system.

1. Fuel

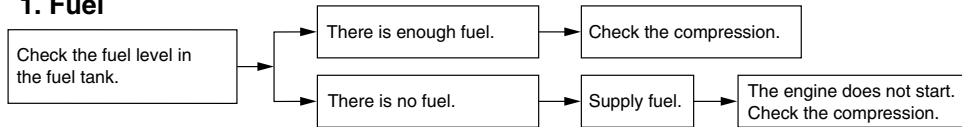

2. Compression

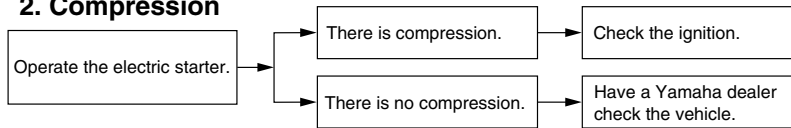

6

3. Ignition

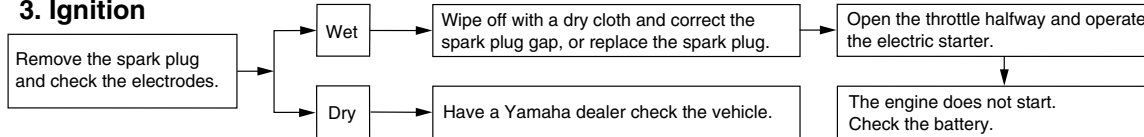

4. Battery

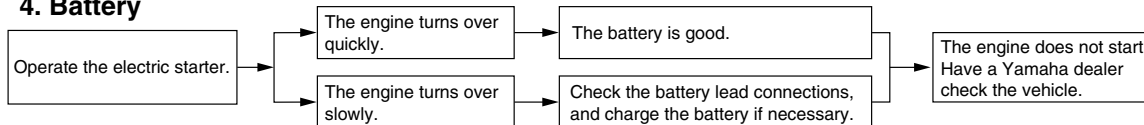

MOTORCYCLE CARE AND STORAGE

EAU26000

Care

While the open design of a motorcycle reveals the attractiveness of the technology, it also makes it more vulnerable. Rust and corrosion can develop even if high-quality components are used. A rusty exhaust pipe may go unnoticed on a car, however, it detracts from the overall appearance of a motorcycle. Frequent and proper care does not only comply with the terms of the warranty, but it will also keep your motorcycle looking good, extend its life and optimize its performance.

Before cleaning

1. Cover the muffler outlet with a plastic bag after the engine has cooled down.
2. Make sure that all caps and covers as well as all electrical couplers and connectors, including the spark plug cap, are tightly installed.
3. Remove extremely stubborn dirt, like oil burnt onto the crankcase, with a degreasing agent and a

brush, but never apply such products onto seals, gaskets, sprockets, the drive chain and wheel axles. Always rinse the dirt and degreaser off with water.

Cleaning

ECA10770

CAUTION:

- **Avoid using strong acidic wheel cleaners, especially on spoked wheels. If such products are used on hard-to-remove dirt, do not leave the cleaner on the affected area any longer than instructed. Also, thoroughly rinse the area off with water, immediately dry it, and then apply a corrosion protection spray.**
- **Improper cleaning can damage windshields, cowlings, panels and other plastic parts. Use only a soft, clean cloth or sponge with mild detergent and water to clean plastic.**
- **Do not use any harsh chemical products on plastic parts. Be sure to avoid using cloths or**

sponges which have been in contact with strong or abrasive cleaning products, solvent or thinner, fuel (gasoline), rust removers or inhibitors, brake fluid, antifreeze or electrolyte.

- **Do not use high-pressure washers or steam-jet cleaners since they cause water seepage and deterioration in the following areas: seals (of wheel and swing-arm bearings, fork and brakes), electric components (couplers, connectors, instruments, switches and lights), breather hoses and vents.**
- **For motorcycles equipped with a windshield: Do not use strong cleaners or hard sponges as they will cause dulling or scratching. Some cleaning compounds for plastic may leave scratches on the windshield. Test the product on a small hidden part of the windshield to make sure that it does not leave**

MOTORCYCLE CARE AND STORAGE

any marks. If the windshield is scratched, use a quality plastic polishing compound after washing.

After normal use

Remove dirt with warm water, a mild detergent, and a soft, clean sponge, and then rinse thoroughly with clean water. Use a toothbrush or bottlebrush for hard-to-reach areas. Stubborn dirt and insects will come off more easily if the area is covered with a wet cloth for a few minutes before cleaning.

After riding in the rain, near the sea or on salt-sprayed roads

Since sea salt or salt sprayed on roads during winter are extremely corrosive in combination with water, carry out the following steps after each ride in the rain, near the sea or on salt-sprayed roads.

NOTE:

Salt sprayed on roads in the winter may remain well into spring.

1. Clean the motorcycle with cold wa-

ter and a mild detergent, after the engine has cooled down.

ECA10790

CAUTION:

Do not use warm water since it increases the corrosive action of the salt.

2. Apply a corrosion protection spray on all metal, including chrome- and nickel-plated, surfaces to prevent corrosion.

After cleaning

1. Dry the motorcycle with a chamois or an absorbing cloth.
2. Immediately dry the drive chain and lubricate it to prevent it from rusting.
3. Use a chrome polish to shine chrome, aluminum and stainless-steel parts, including the exhaust system. (Even the thermally induced discoloring of stainless-steel exhaust systems can be removed through polishing.)
4. To prevent corrosion, it is recommended to apply a corrosion pro-

tection spray on all metal, including chrome- and nickel-plated, surfaces.

5. Use spray oil as a universal cleaner to remove any remaining dirt.
6. Touch up minor paint damage caused by stones, etc.
7. Wax all painted surfaces.
8. Let the motorcycle dry completely before storing or covering it.

EWA10930

WARNING

- **Make sure that there is no oil or wax on the brakes or tires. If necessary, clean the brake discs and brake linings with a regular brake disc cleaner or acetone, and wash the tires with warm water and a mild detergent.**
- **Before operating the motorcycle test its braking performance and cornering behavior.**

ECA10800

CAUTION:

- **Apply spray oil and wax spar-**

MOTORCYCLE CARE AND STORAGE

ingly and make sure to wipe off any excess.

- Never apply oil or wax to any rubber and plastic parts, but treat them with a suitable care product.
- Avoid using abrasive polishing compounds as they will wear away the paint.

NOTE: _____

Consult a Yamaha dealer for advice on what products to use.

EAU26150

Storage

Short-term

Always store your motorcycle in a cool, dry place and, if necessary, protect it against dust with a porous cover.

ECA10810

CAUTION: _____

- Storing the motorcycle in a poorly ventilated room or covering it with a tarp, while it is still wet, will allow water and humidity to seep in and cause rust.
- To prevent corrosion, avoid damp cellars, stables (because of the presence of ammonia) and areas where strong chemicals are stored.

Long-term

Before storing your motorcycle for several months:

1. Follow all the instructions in the “Care” section of this chapter.
2. For motorcycles equipped with a fuel cock that has an “OFF” position: Turn the fuel cock lever to “OFF”.

3. Drain the carburetor float chamber by loosening the drain bolt; this will prevent fuel deposits from building up. Pour the drained fuel into the fuel tank.
4. Fill up the fuel tank and add fuel stabilizer (if available) to prevent the fuel tank from rusting and the fuel from deteriorating.
5. Perform the following steps to protect the cylinder, piston rings, etc. from corrosion.
 - a. Remove the spark plug cap and spark plug.
 - b. Pour a teaspoonful of engine oil into the spark plug bore.
 - c. Install the spark plug cap onto the spark plug, and then place the spark plug on the cylinder head so that the electrodes are grounded. (This will limit sparking during the next step.)
 - d. Turn the engine over several times with the starter. (This will coat the cylinder wall with oil.)
 - e. Remove the spark plug cap

MOTORCYCLE CARE AND STORAGE

from the spark plug, and then install the spark plug and the spark plug cap.

EWA10950

WARNING

To prevent damage or injury from sparking, make sure to ground the spark plug electrodes while turning the engine over.

6. Lubricate all control cables and the pivoting points of all levers and pedals as well as of the sidestand/centerstand.
7. Check and, if necessary, correct the tire air pressure, and then lift the motorcycle so that both of its wheels are off the ground. Alternatively, turn the wheels a little every month in order to prevent the tires from becoming degraded in one spot.
8. Cover the muffler outlet with a plastic bag to prevent moisture from entering it.
9. Remove the battery and fully charge it. Store it in a cool, dry

place and charge it once a month. Do not store the battery in an excessively cold or warm place [less than 0 °C (30 °F) or more than 30 °C (90 °F)]. For more information on storing the battery, see page 6-27.

NOTE: _____
Make any necessary repairs before storing the motorcycle.

Dimensions:

- Overall length:
2135 mm (84.1 in)
- Overall width:
820 mm (32.3 in)
- Overall height:
1120 mm (44.1 in)
- Seat height:
820 mm (32.3 in)
- Wheelbase:
1350 mm (53.1 in)
- Ground clearance:
255 mm (10.04 in)
- Minimum turning radius:
2100 mm (82.7 in)

Weight:

- With oil and fuel:
127.0 kg (280 lb)

Engine:

- Engine type:
Air cooled 4-stroke, SOHC
- Cylinder arrangement:
Forward-inclined single cylinder
- Displacement:
125.0 cm³ (7.63 cu.in)
- Bore × stroke:
57.0 × 48.8 mm (2.24 × 1.92 in)
- Compression ratio:
10.00 :1
- Starting system:
Electric starter
- Lubrication system:
Wet sump

EAU26333

Engine oil:

Type:

SAE10W30 or SAE10W40 or SAE15W40
or SAE20W40 or SAE20W50

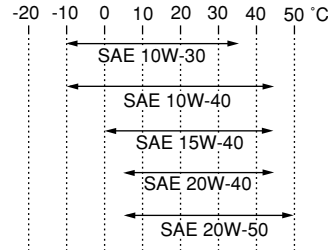

Recommended engine oil grade:
API service SE, SF, SG type or higher

Engine oil quantity:

- Without oil filter element removal:
1.00 L (1.06 US qt) (0.88 Imp.qt)
- With oil filter element removal:
1.10 L (1.16 US qt) (0.97 Imp.qt)

Air filter:

- Air filter element:
Wet element

Fuel:

- Recommended fuel:
Regular unleaded gasoline only
- Fuel tank capacity:
7.0 L (1.85 US gal) (1.54 Imp.gal)
- Fuel reserve amount:
1.7 L (0.45 US gal) (0.37 Imp.gal)

Carburetor:

- Manufacturer:
TEIKEI
- Type x quantity:
MV28 x 1

Spark plug(s):

- Manufacturer/model:
NGK/DR8EA
- Spark plug gap:
0.6–0.7 mm (0.024–0.028 in)

Clutch:

- Clutch type:
Wet, multiple-disc

Transmission:

- Primary reduction system:
Spur gear
- Primary reduction ratio:
74/20 (3.700)
- Secondary reduction system:
Chain drive
- Secondary reduction ratio:
51/14 (3.643)
- Transmission type:
Constant mesh 5-speed
- Operation:
Left foot operation

Gear ratio:

- 1st:
36/16 (2.250)
- 2nd:
31/21 (1.476)
- 3rd:
27/24 (1.125)

SPECIFICATIONS

4th:
25/27 (0.926)

5th:
23/29 (0.793)

Chassis:

Frame type:
Diamond

Caster angle:
25.8 °

Trail:
93.0 mm (3.66 in)

Front tire:

Type:
With tube

Size:
130/80-18M/C 66P
Manufacturer/model:
BRIDGESTONE/TW-203

Rear tire:

Type:
With tube

Size:
180/80-14M/C 78P
Manufacturer/model:
BRIDGESTONE/TW-204

Loading:

Maximum load:
180 kg (397 lb)

(Total weight of rider, passenger, cargo
and accessories)

Tire air pressure (measured on cold tires):

Loading condition:
0–90 kg (0–198 lb)

Front:
150 kPa (22 psi) (1.50 kgf/cm²)

Rear:
150 kPa (22 psi) (1.50 kgf/cm²)

Loading condition:
90–180 kg (198–397 lb)

Front:
150 kPa (22 psi) (1.50 kgf/cm²)

Rear:
175 kPa (25 psi) (1.75 kgf/cm²)

Front wheel:

Wheel type:
Spoke wheel

Rim size:
18x2.50

Rear wheel:

Wheel type:
Spoke wheel

Rim size:
14M/C x MT4.50

Front brake:

Type:
Single disc brake

Operation:
Right hand operation

Recommended fluid:
DOT 4

Rear brake:

Type:
Drum brake
Operation:
Right foot operation

Front suspension:

Type:
Telescopic fork
Spring/shock absorber type:
Coil spring/oil damper
Wheel travel:
150.0 mm (5.91 in)

Rear suspension:

Type:
Swingarm (monocross)
Spring/shock absorber type:
Coil spring/gas-oil damper
Wheel travel:
150.0 mm (5.91 in)

Electrical system:

Ignition system:
C.D.I.
Charging system:
A.C. magneto

Battery:

Model:
GT6B-3
Voltage, capacity:
12 V, 6.0 Ah

Headlight:

Bulb type:
Halogen bulb

Bulb voltage, wattage x quantity:

Headlight:

12 V, 60 W/55.0 W × 1

Tail/brake light:

12 V, 5.0/21.0 W × 1

Front turn signal light:

12 V, 21.0 W × 2

Rear turn signal light:

12 V, 21.0 W × 2

Auxiliary light:

12 V, 4.0 W × 1

Meter lighting:

12 V, 3.4 W × 1

Neutral indicator light:

12 V, 3.4 W × 1

High beam indicator light:

12 V, 3.4 W × 1

Turn signal indicator light:

12 V, 3.4 W × 1

Fuse:

Fuse:

20.0 A

CONSUMER INFORMATION

EAU26351

Identification numbers

Record the key identification number, vehicle identification number and model label information in the spaces provided below for assistance when ordering spare parts from a Yamaha dealer or for reference in case the vehicle is stolen.

KEY IDENTIFICATION NUMBER:

VEHICLE IDENTIFICATION NUMBER:

MODEL LABEL INFORMATION:

Key identification number

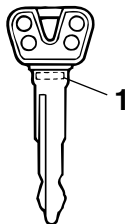

1. Key identification number

The key identification number is stamped into the key. Record this number in the space provided and use it for reference when ordering a new key.

EAU26390

Vehicle identification number

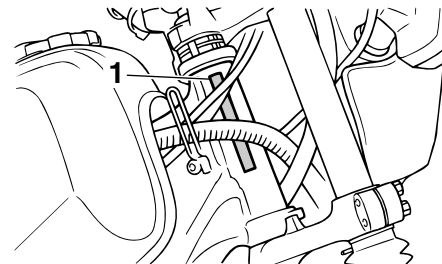

1. Vehicle identification number

The vehicle identification number is stamped into the steering head pipe. Record this number in the space provided.

NOTE: _____

The vehicle identification number is used to identify your motorcycle and may be used to register your motorcycle with the licensing authority in your area.

EAU26400

EAU26460

Model label

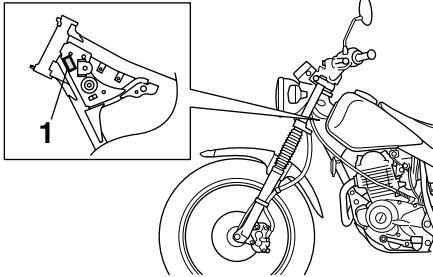

1. Model label

The model label is affixed to the location shown. Record the information on this label in the space provided. This information will be needed when ordering spare parts from a Yamaha dealer.



PRINTED ON RECYCLED PAPER

PRINTED IN JAPAN
2003.9-0.2x1 
(E)