



**2016 WaveRunner
FX HO
FX Cruiser HO**

OWNER'S/OPERATOR'S MANUAL

**▲ Read this manual carefully
before operating this watercraft.**

YAMAHA MOTOR CO., LTD.
F2T-F8199-75-E0

Read this manual carefully before operating this watercraft. This manual should stay with the WaveRunner if it is sold.

Important manual information

EJU37599

Declaration of Conformity for Personal Watercraft (PWC)

with the requirements of Directive 94/25/EC, as amended by Directive 2003/44/EC

Name of PWC Manufacturer: YAMAHA MOTOR CO., LTD.

Address: 2500 Shingai, Iwata, Shizuoka 438-8501, Japan

Name of Authorised Representative: YAMAHA MOTOR EUROPE N.V.

Address: Koolhovenlaan 101, 1119 NC Schiphol-Rijk, The Netherlands

Name of Notified Body for exhaust and noise emission assessment: SNCH ID Number: 0499

Address: 11, route de Luxembourg BP 32, Sandweiler, L-5230, Luxembourg

Conformity assessment module used:

for construction: A Aa B+C B+D B+E B+F G H

for exhaust emissions: B+C B+D B+E B+F G H

for noise emissions: A Aa G H

Other Community Directives applied		Standards	
<input checked="" type="checkbox"/>	Directive 2004/108/EC relating to electromagnetic compatibility (EMC).	<input checked="" type="checkbox"/>	CISPR 12
		<input checked="" type="checkbox"/>	EN 61000-6-2
<input type="checkbox"/>	Directive 2006/42/EC relating to Machinery.	<input type="checkbox"/>	

DESCRIPTION OF CRAFT

Craft model Identification Number, starting from : U | S | - | Y | A | M | A | 0 | 0 | 0 | 1 | F | 5 | 1 | 6

Design Category : C D

Model name / Commercial name : FB1800A-R / FX Cruiser HO, FB1800-R / FX HO

DESCRIPTION OF ENGINE

Engine Type:	Fuel Type:	Combustion cycle:
<input checked="" type="checkbox"/> PWC engine	<input checked="" type="checkbox"/> Petrol	<input checked="" type="checkbox"/> 4 stroke

IDENTIFICATION OF ENGINE COVERED BY THIS DECLARATION OF CONFORMITY

Name of engine model	EC Type-examination certificate number	Name / ID number of Notified Body
6CR	SNCH*94/25*2003/44*0044	SNCH / 0499

ESSENTIAL REQUIREMENTS

Essential requirements	standards	other normative document / method	technical file	Please specify in more detail (* = mandatory standard)
I.A design and construction	<input checked="" type="checkbox"/>	<input type="checkbox"/>	<input checked="" type="checkbox"/>	EN ISO 13590
I.B exhaust emission	<input checked="" type="checkbox"/> *	<input type="checkbox"/>	<input checked="" type="checkbox"/>	*EN ISO 8178-1
I.C noise emission	<input checked="" type="checkbox"/> *	<input type="checkbox"/>	<input checked="" type="checkbox"/>	*EN ISO 14509

This declaration of conformity is issued under the sole responsibility of the manufacturer. I declare on behalf of the PWC manufacturer that the craft model(s) and engine(s) mentioned above complies (comply) with all applicable essential requirements in the way specified and is (are) in conformity with the type(s) for which above mentioned EC type-examination certificate(s) has (have) been issued.

Name / Title: Y. Henmi / General Manager of Engineering Section, BOAT Business Unit
(identification of the person empowered to sign on behalf of the manufacturer)

Signature:
(or an equivalent marking)

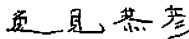

Date and place of issue: 1st / June / 2015, Shizuoka, Japan

Important manual information

EJU30193

To the owner/operator

Thank you for choosing a Yamaha watercraft. This owner's/operator's manual contains information you will need for proper operation, maintenance, and care. If you have any questions about the operation or maintenance of your watercraft, please consult a Yamaha dealer.

This manual is not a course on boating safety or seamanship. If this is your first watercraft, or if you are changing to a type of watercraft you are not familiar with, for your own comfort and safety, please ensure that you obtain proper training or practice before operating the watercraft by yourself. In addition, a Yamaha dealer or boating organization will be pleased to recommend local sea schools, or competent instructors.

In this manual, information of particular importance is distinguished in the following ways:

 This is the safety alert symbol. It is used to alert you to potential personal injury hazards. Obey all safety messages that follow this symbol to avoid possible injury or death.

EWJ00072

WARNING

A WARNING indicates a hazardous situation which, if not avoided, could result in death or serious injury.

ECJ00092

NOTICE

A NOTICE indicates special precautions that must be taken to avoid damage to the watercraft or other property.

TIP:

A TIP provides key information to make procedures easier or clearer.

EJU40411

Because Yamaha has a policy of continuing product improvement, this product may not be exactly as described in this owner's/operator's manual. Specifications are subject to change without notice.

This manual should be considered a permanent part of this watercraft and should remain with it even if the watercraft is subsequently sold.

EJU30233

**WaveRunner FX HO/FX Cruiser HO
OWNER'S/OPERATOR'S MANUAL
©2015 by Yamaha Motor Co., Ltd.
1st Edition, April 2015
All rights reserved.
Any reprinting or unauthorized use
without the written permission of
Yamaha Motor Co., Ltd.
is expressly prohibited.
Printed in U.S.A.**

Table of contents

General and important labels	1	Watercraft operation	32
Identification numbers	1	Watercraft operation functions	32
Primary Identification (PRI-ID)		Shift system.....	32
number.....	1	Electric trim system.....	34
Craft Identification Number (CIN).....	1	Watercraft operation modes.....	36
Engine serial number.....	1	Low RPM Mode	36
Manufactured date label	2	No-wake mode.....	37
Model information	2	Cruise assist.....	38
Builder's plate	2		
Important labels	4	Instrument operation	40
Warning labels.....	5	Multifunction information center...	40
Other labels.....	9	Analog speedometer/tachometer....	40
		Information display.....	41
Safety information	11	Multifunction display	45
Limitations on who may operate			
the watercraft.....	11	Equipment operation	49
Cruising limitations.....	12	Equipment.....	49
Operation requirements	13	Seats	49
Recommended equipment	15	Handgrip.....	50
Hazard information.....	16	Reboarding grip.....	50
Watercraft characteristics.....	16	Reboarding step.....	50
Wakeboarding and water-skiing ...	18	Bow eye.....	51
Safe boating rules	19	Stern eyes	51
Enjoy your watercraft		Cleat	51
responsibly.....	20	Pull-up cleats (FX Cruiser HO).....	52
		Storage compartments	52
		Fire extinguisher holder and cover...	57
Description	21		
Watercraft glossary	21	Operation and handling	
Location of main components	22	requirements	58
		Fuel requirements.....	58
Control function operation	26	Fuel.....	58
Watercraft control functions	26	Engine oil requirements	60
Remote control transmitter	26	Engine oil.....	60
Yamaha Security System.....	27	Draining the bilge water.....	62
Engine stop switch	28	Draining the bilge water on land.....	62
Engine shut-off switch	28	Draining the bilge water on water ...	62
Start switch	28	Transporting on a trailer.....	63
Throttle lever	29		
RiDE lever.....	29	First-time operation	64
Steering system	29	Engine break-in.....	64
Adjustable tilt steering system	30		
Cooling water pilot outlet	31		
Water separator.....	31		

Table of contents

Pre-operation checks	65	Removing and installing the engine cover	93
Pre-operation checklist	65	Periodic maintenance chart	95
Pre-operation check points.....	67	Engine oil and oil filter	97
Pre-launch checks	67		
Post-launch checks	73		
Operation	76	Specifications.....	98
Operating your watercraft	76	Specifications	98
Getting to know your watercraft	76		
Learning to operate your watercraft.....	76	Trouble recovery.....	99
Riding position	77	Troubleshooting.....	99
Launching the watercraft	77	Troubleshooting chart	99
Starting the engine on water.....	77	Emergency procedures	102
Stopping the engine	78	Cleaning the jet intake and impeller	102
Leaving the watercraft.....	78	Raising the reverse gate.....	103
Operating the watercraft	78	Jumping the battery	103
Turning the watercraft	79	Replacing the fuses.....	104
Stopping the watercraft	80	Towing the watercraft.....	106
Operating the watercraft in reverse or neutral.....	81	Submerged watercraft	106
Boarding the watercraft	82		
Starting off.....	84	Index.....	108
Capsized watercraft	85		
Beaching and docking the watercraft.....	86		
Operating in weeded areas	86		
After removing the watercraft from the water	87		
Care and storage.....	88		
Post-operation care	88		
Flushing the cooling water passages.....	88		
Cleaning the watercraft	89		
Battery care.....	89		
Long-term storage	92		
Cleaning	92		
Lubrication	92		
Rustproofing.....	92		
Maintenance	93		
Maintenance.....	93		
Tool kit.....	93		

General and important labels

EJU36452

Identification numbers

Record the Primary Identification (PRI-ID) number, Craft Identification Number (CIN), and engine serial number in the spaces provided for assistance when ordering spare parts from a Yamaha dealer. Also record and keep these ID numbers in a separate place in case your watercraft is stolen.

EJU42521

Primary Identification (PRI-ID) number

The PRI-ID number is stamped on a plate attached inside the engine compartment. (See page 49 for seat removal and installation procedures and page 55 for information on the removable watertight storage compartment.)

MODEL:

FB1800-R (FX HO)

FB1800A-R (FX Cruiser HO)

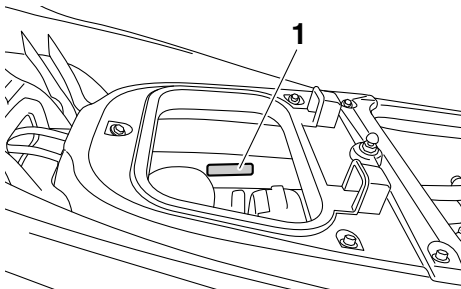

1 Primary Identification (PRI-ID) number location

MODEL <input type="text"/>	PRI-ID <input type="text"/>
YAMAHA MOTOR CO., LTD. ASSEMBLED IN U.S.A. FROM AMERICAN AND JAPANESE COMPONENTS.	F2T <input type="text"/>
ASSEMBLÉ AUX ÉTATS-UNIS DE PIÈCES AMÉRICAINES ET JAPONAISES.	

F 2 T -

EJU36551

Craft Identification Number (CIN)

The CIN is stamped on a plate attached to the aft deck.

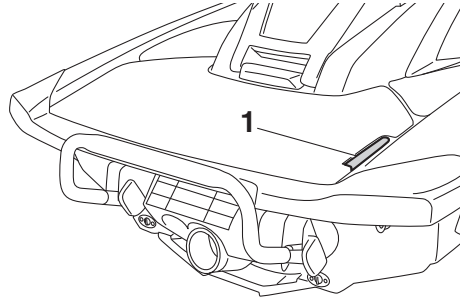

1 Craft Identification Number (CIN) location

U S - Y A M

EJU30312

Engine serial number

The engine serial number is stamped on a plate attached to the engine unit. (See page 49 for seat removal and installation procedures.)

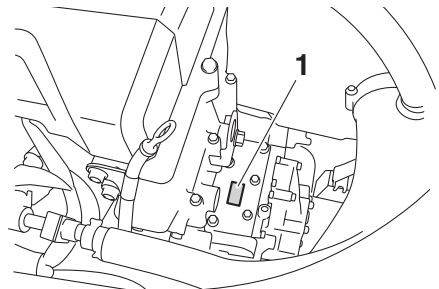

1 Engine serial number location

YAMAHA

YAMAHA MOTOR CO., LTD.

MADE IN JAPAN

PAYS D'ORIGINE JAPON

General and important labels

EJU42031

Manufactured date label

This label is attached to the top of the cylinder head. (See page 49 for seat removal and installation procedures and page 93 for engine cover removal and installation procedures.)

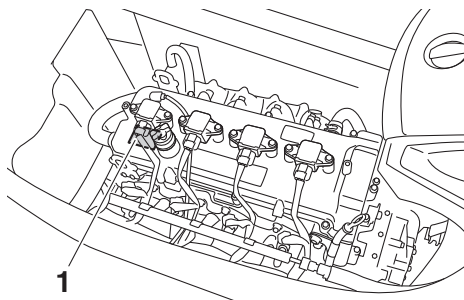

1 Manufactured date label location

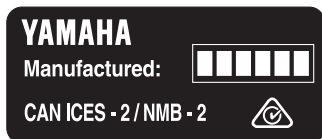

EJU30321

Model information

EJU30332

Builder's plate

Watercraft with this label conform to certain portions of the European Parliament directive relating to machinery.

Part of the information is given on the builder's plate affixed on the craft. A full explanation of this information is given in the relevant sections of this manual.

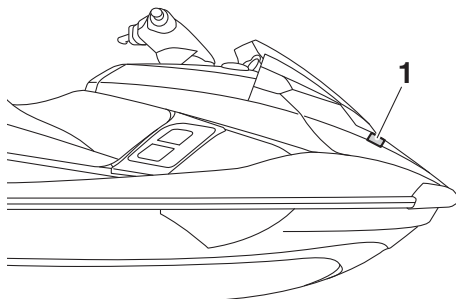

1 Builder's plate location

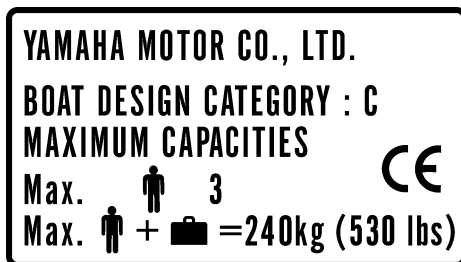

Design category of this personal watercraft: C

Category C:

This watercraft is designed to operate in winds up to Beaufort force 6 and the associated wave heights (significant wave heights up to 2 m (6.56 ft); see the following TIP). Such conditions may be encountered in exposed inland waters, in estuaries, and in coastal waters in moderate weather conditions.

General and important labels

TIP:

The significant wave height is the mean height of the highest one-third of the waves, which approximately corresponds to the wave height estimated by an experienced observer. However, some waves will be double this height.

General and important labels

EJU30453

Important labels

Read the following labels before using this watercraft. If have any questions, consult a Yamaha dealer.

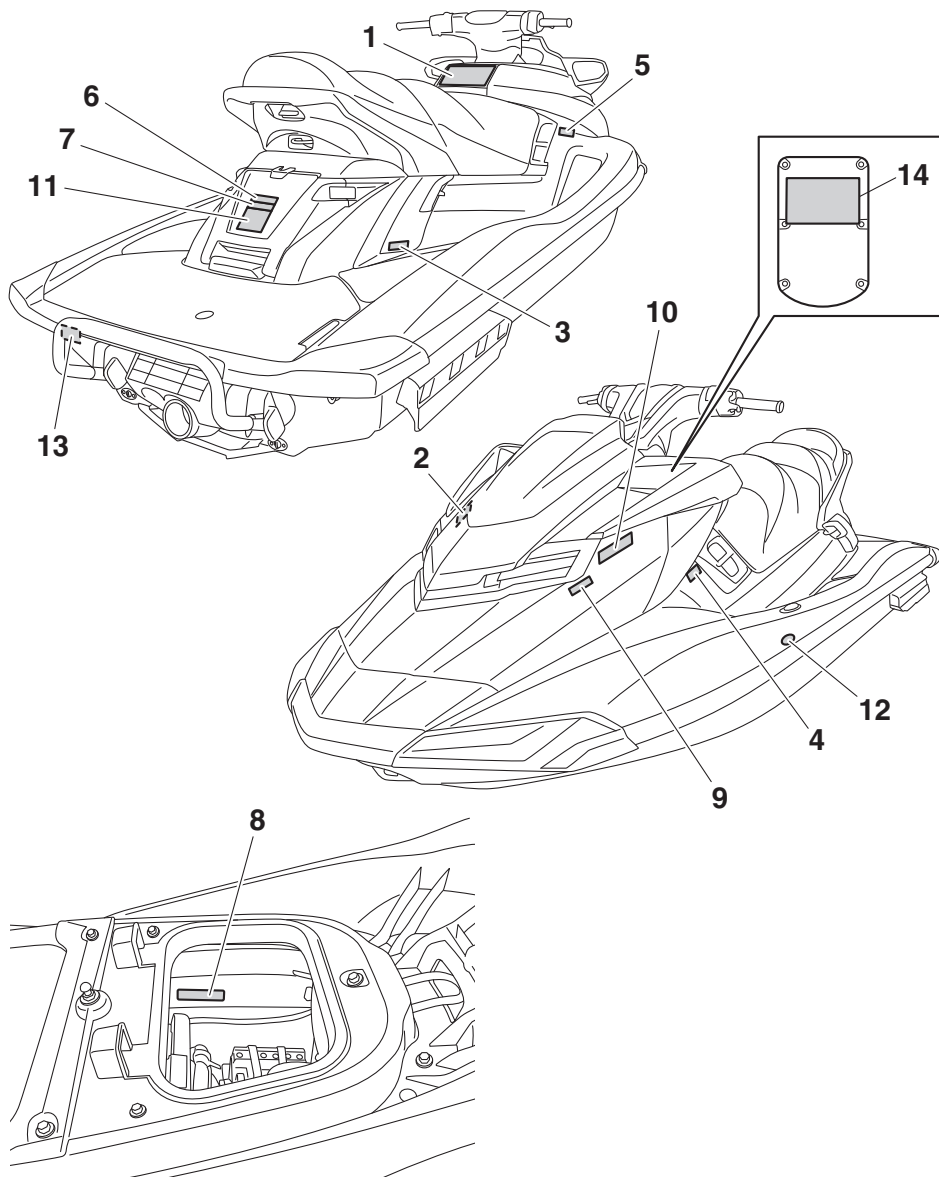

General and important labels

EJU35914

Warning labels

If any of these labels are damaged or missing, contact a Yamaha dealer for replacements.

1

⚠ WARNING

To reduce the risk of SEVERE INJURY or DEATH:

WEAR A PERSONAL FLOTATION DEVICE (PFD). All riders must wear an authority-approved PFD that is suitable for personal watercraft (PWC) use.

WEAR PROTECTIVE CLOTHING. Severe internal injuries can occur if water is forced into body cavities as a result of falling into water or being near jet thrust nozzle. Normal swimwear does not adequately protect against forceful water entry into rectum or vagina. All riders must wear a wet suit bottom or clothing that provides equivalent protection (See Owner's Manual).

Footwear, gloves, and goggles/glasses are recommended.

KNOW BOATING LAWS. Yamaha Motor Co., Ltd. recommends a minimum operator age of 16 years old. Know the operator age and training requirements for your state. A boating safety course is recommended and may be required in your state.

ATTACH ENGINE SHUT-OFF CORD (LANYARD) to wrist and keep it free from handlebars so that engine stops if operator falls off. After riding, remove cord from PWC to avoid unauthorized use by children or others.

RIDE WITHIN YOUR LIMITS AND AVOID AGGRESSIVE MANEUVERS to reduce the risk of loss of control, ejection, and collision. This is a high performance boat - not a toy. Sharp turns or jumping wakes or waves can increase the risk of back/spinal injury (paralysis), facial injuries, and broken legs, ankles, and other bones.
Do not jump wakes or waves.

DO NOT APPLY THROTTLE WHEN ANYONE IS AT REAR OF PWC-turn engine off or keep engine at idle. Water and/or debris exiting jet thrust nozzle can cause severe injury.

⚠ WARNING

KEEP AWAY FROM INTAKE GRATE while engine is on. Items such as long hair, loose clothing, or PFD straps can become entangled in moving parts resulting in severe injury or drowning.

NEVER RIDE AFTER CONSUMING DRUGS OR ALCOHOL

Collisions result in more **INJURIES AND DEATHS** than any other type of accident for personal watercraft (PWC).

TO AVOID COLLISIONS:
SCAN CONSTANTLY for people, objects, and other watercraft. Be alert for conditions that limit your visibility or block your vision of others.

OPERATE DEFENSIVELY at safe speeds and keep a safe distance away from people, objects, and other watercraft.

- Do not follow directly behind PWCs or other boats.
- Do not go near others to spray or splash them with water.
- Avoid sharp turns or other maneuvers that make it hard for others to avoid you or understand where you are going.
- Avoid areas with submerged objects or shallow water.

TAKE EARLY ACTION to avoid collisions. Remember, PWCs and other boats do not have brakes.

DO NOT RELEASE THROTTLE WHEN TRYING TO STEER away from objects - you need throttle to steer. Always check throttle and steering controls for proper operation before starting PWC. Follow navigation rules and state/province and local laws that apply to PWCs. See Owner's Manual for more information.



READ AND FOLLOW OWNER'S MANUAL

YAMAHA

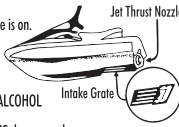
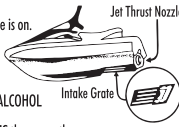



F2S-U41B1-10

2

⚠ AVERTISSEMENT

Afin de limiter les risques de BLESSURES GRAVES, voire MORTELLES: PORTER UN GILET DE SAUVETAGE. Tout utilisateur doit porter un gilet de sauvetage homologué pour les scooters des mers. PORTER DES VÊTEMENTS PROTÉCTEURS. Le choc infligé par la pénétration forcée d'eau dans les orifices corporels lors d'une chute ou lors du contact avec le jet d'eau de la pompe risque de provoquer des lésions graves. Le port d'un simple maillot de bain ne constitue pas une protection adéquate contre la puissance de pénétration de l'eau dans le rectum et/ou le vagin. Tout utilisateur doit porter le pantalon d'une tenue de plongée ou tout autre vêtement offrant une protection semblable. (Voir le manuel d'utilisation.) Le port de chaussures, de gants et de lunettes de plongée est recommandé. CONNAÎTRE LES LOIS DE NAVIGATION. La Yamaha Motor Co., Ltd. recommande la limite d'âge de pilotage de 16 ans. Vérifier l'âge du pilote ainsi que les exigences quant à l'âge prévues par la législation locale. Il est préférable, et parfois requis par certaines législations, de suivre un cours de sécurité maritime. ATTACHER LA LANIÈRE DE L'INTERRUPTEUR D'ARRÊT DU MOTEUR au poignet et l'éloigner du guidon afin que le moteur se coupe bien en cas de chute. Après utilisation, retirer la lanière du scooter afin de prévenir toute utilisation par des enfants ou des personnes non-autorisées.



Gilet de sauvetage

Pantalon d'une tenue de plongée

F1B-U41B1-21

General and important labels

3

⚠ AVERTISSEMENT

Afin de limiter les risques de BLESSURES GRAVES, voire MORTELLES:

RESPECTER SES LIMITES ET ÉVITER LES MANOEUVRES BRUTALES afin de limiter tout risque de perte de contrôle, d'éjection et de collision. Il s'agit d'un véhicule à hautes performances et pas d'un jouet. Des virées brusques ou le saut de sillages ou de vagues accroît le risque de blessures au dos, voire de paralysie, de blessures au visage et de fractures d'os. **Ne jamais sauter des sillages ni des vagues.**

NE PAS DONNER DES GAZ LORSQUE QUELQU'UN SE TROUVE DERRIÈRE LE VÉHICULE: couper le moteur ou laisser tourner au ralenti. Eau et/ou débris projetés par la pompe pourraient causer des blessures graves.

NE PAS S'APPROCHER DE LA GRILLE D'ADMISSION lorsque le moteur tourne. Cheveux longs, vêtements amples ou lanières de gilet de sauvetage risquent d'être happés, ce qui pourrait provoquer des blessures, ou même une noyade.

NE JAMAIS PILOTER APRÈS AVOIR ABSORBÉ DE L'ALCOOL, DES DROGUES OU CERTAINS MÉDICAMENTS.

LIRE ET RESPECTER LES INSTRUCTIONS DONNÉES
DANS LE MANUEL D'UTILISATION.

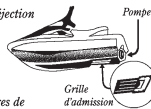

YAMAHA
F1B-U41B1-31
F2S-U41B1-30

4

⚠ AVERTISSEMENT

Les collisions sont la cause principale des BLESSURES ET DÉCÈS

d'utilisateurs de scooter des mers. **POUR ÉVITER LES**

COLLISIONS, ÊTRE CONSTAMMENT à l'affût de

personnes, d'objets et d'autres bateaux. Être conscient des

conditions limitant sa visibilité ou celle des autres embarcations.

PILOTER AVEC PRUDENCE à des vitesses raisonnables

et garder une distance de sécurité entre le scooter et toute personne, objet et embarcation.

• Ne pas suivre une autre embarcation de trop près.

• Ne pas se rapprocher d'autrui en vue de l'éclabousser.

• Éviter les virages brusques ou toute manoeuvre qui risque de mettre un autre pilote

en danger ou qui l'empêche de pouvoir déterminer clairement la direction que l'on prend.

• Éviter les endroits où flottent des objets et les eaux peu profondes.

REAGIR RAPIDEMENT en vue d'éviter les collisions. Garder à l'esprit que les

bateaux n'ont pas de freins.

NE PAS LÂCHER LES GAZ LORSQUE L'ON ESSAYE DE S'ÉLOIGNER

d'objets—une poussée est nécessaire à la direction du scooter des mers. Toujours

s'assurer avant le départ que l'accélérateur et la direction fonctionnent

correctement. Suivre les lois de navigation ainsi que les législations nationales,

provinciales et locales concernant les scooters des mers.

Voir le manuel d'utilisation pour plus

d'informations.



YAMAHA

F1B-U41B2-01

⚠ AVERTISSEMENT

Les collisions sont la cause principale des BLESSURES
ET DÉCÈS d'utilisateurs de scooter des mers.

POUR ÉVITER LES COLLISIONS:

ÊTRE CONSTAMMENT à l'affût de personnes,

d'objets et d'autres bateaux. Être conscient des

conditions limitant sa visibilité ou celle des

autres embarcations.

PILOTER AVEC PRUDENCE à des vitesses

raisonnables et garder une distance de sécurité entre le scooter et toute

personne, objet et embarcation.

• Ne pas suivre une autre embarcation de trop près.

• Ne pas se rapprocher d'autrui en vue de l'éclabousser.

• Éviter les virages brusques ou toute manoeuvre qui risque de mettre un

autre pilote en danger ou qui l'empêche de pouvoir déterminer clairement la

direction que l'on prend.

• Éviter les endroits où flottent des objets et les eaux peu profondes.

REAGIR RAPIDEMENT en vue d'éviter les collisions. Garder à l'esprit que les

bateaux n'ont pas de freins.

NE PAS LÂCHER LES GAZ LORSQUE L'ON ESSAYE DE S'ÉLOIGNER

d'objets—une poussée est nécessaire à la direction du scooter des mers.

Toujours s'assurer avant le départ que l'accélérateur et la direction

fonctionnent correctement.

Suivre les lois de navigation ainsi que les législations nationales, provinciales

et locales concernant les scooters des mers. Voir le manuel d'utilisation pour

plus d'informations.



YAMAHA

F0M-U41B2-11

6

General and important labels

5

⚠ WARNING	⚠ AVERTISSEMENT
<p>Gasoline is highly flammable and explosive. A fire or explosion could cause severe injury or death. Shut engine off. Refuel in well ventilated area away from flames or sparks. Do not smoke. Avoid spilling gasoline. Wipe up spilled gasoline immediately. Remove all seats to ventilate fuel vapors from engine compartment before starting engine. Do not start engine if there is a fuel leak or a loose electrical connection.</p>	<p><i>L'essence est très inflammable et explosible. Un incendie ou une explosion risquent de provoquer des blessures graves, voire mortelles. Couper le moteur. Faire le plein dans un endroit bien aéré et éloigné de toute flamme ou étincelle. Ne pas fumer. Éviter de renverser de l'essence. Essuyer immédiatement toute coulure d'essence. Déposer les selles pour évacuer les vapeurs d'essence du compartiment du moteur avant de mettre le moteur en marche. Ne jamais mettre le moteur en marche en cas de fuite d'essence ou si un branchement électrique est desserré.</i></p>
REGULAR UNLEADED GASOLINE ONLY	ESSENCE NORMALE SANS PLOMB UNIQUEMENT

F1S-U415B-11
F1B-U415B-11

6

⚠ WARNING
<p>Do not use cleat or grips to lift PWC. PWC could fall, which could result in severe injury.</p>
⚠ AVERTISSEMENT
<p>Ne pas soulever le scooter à l'aide du taquet ou des poignées. Le scooter pourrait tomber et provoquer des blessures graves.</p>

(F1S-U41E1-11)
(F2S-U41E1-10)

7

⚠ WARNING
<ul style="list-style-type: none">• Severe internal injuries can occur if water is forced into body cavities as a result of being near jet thrust nozzle.• Wear a wetsuit bottom or clothing that provides equivalent protection.• Do not board PWC if operator is applying throttle.
⚠ AVERTISSEMENT
<ul style="list-style-type: none">• Le choc infligé par la pénétration forcée d'eau dans les orifices corporels lors du contact avec le jet de la pompe risque de provoquer des lésions graves.• Porter le pantalon d'une tenue de plongée ou tout autre vêtement offrant une protection semblable.• Ne pas embarquer lorsque la pilote donne des gaz.

(F1S-U41E1-11)
(F2S-U41E1-10)

General and important labels

8

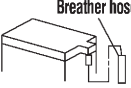
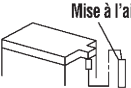
⚠ WARNING	
Be sure to connect breather hose to battery. Fire or explosion could result if not connected properly.	 <p>Breather hose</p>
⚠ AVERTISSEMENT	
Bien veiller à brancher la durit de mise à l'air à la batterie. Un mauvais branchement risque d'être à l'origine d'un incendie ou d'une explosion.	 <p>Mise à l'air</p>
YAMAHA	

F0V-U41DB-12

9

⚠ AVERTISSEMENT	
APPLICABLE POUR LA FRANCE SEULEMENT	
<ul style="list-style-type: none">• <i>En France : permis de conduire et immatriculation obligatoire.</i>• <i>Navigation en mer autorisée entre 300 mètres et 2 milles nautique.</i>• <i>Entre 0 et 300 mètres, se référer aux instructions nautiques locales affichées. Sinon, règle générale : vitesse maxi 5 noeuds (9Km/h) dans cette zone.</i>• <i>Utiliser les chenaux obligatoires de sortie lorsqu'ils existent.</i>• <i>Respecter les règles de priorité.</i>• <i>Gilet de sauvetage obligatoire-Fusée et bout de remorquage à bord.</i>• <i>Ne jamais conduire sous l'influence de l'alcool ou de drogues.</i>• <i>Consulter la météo avant de sortir en mer.</i>• <i>Une conduite responsable et un contrôle quotidien de votre machine suivant le manuel d'entretien YAMAHA seront garants de votre sécurité.</i>	
YAMAHA	

GP8-U416H-01

General and important labels

EJU36262

Other labels

10

**FIRE EXTINGUISHER CONTAINER
COMPARTIMENT DE L'EXTINCTEUR**

F1B-U41F5-21

11

**RATED PERSON CAPACITY: 3
MAXIMUM LOAD: 240 kg (530 lb)
CAPACITÉ MAXIMALE: 3 personnes
CHARGE MAXIMALE: 240 kg(530 lb)**

(F1S-U41E1-11)
(F2S-U41E1-10)

12



General and important labels

The following label indicates the correct direction to upright a capsized watercraft.

13

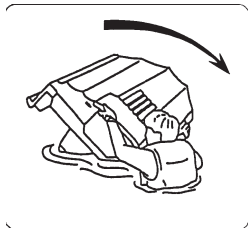
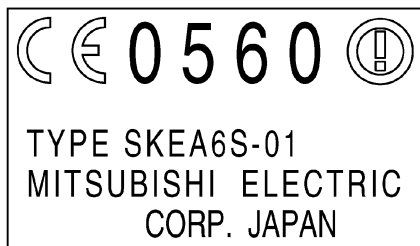

FIG-U418F-00

The following CE marking is located on the back of the remote control transmitter.

14



EJU30683

The safe use and operation of this watercraft is dependent upon the use of proper riding techniques, as well as upon the common sense, good judgment, and expertise of the operator. Before using this watercraft, make sure that its use is permitted under local laws, bylaws, and regulations, and always operate the watercraft in full conformity with any requirements and limitations imposed. Every operator should know the following requirements before riding the watercraft.

- Before operating the watercraft, read this owner's/operator's manual, the Riding Practice Guide, the Riding Instruction card, and all labels on the watercraft. These materials should give you an understanding of the watercraft and its operation.
- Never allow anyone to operate this watercraft until they too have read this owner's/operator's manual, the Riding Practice Guide, the Riding Instruction card, and all labels.

EJU30742

Limitations on who may operate the watercraft

- Yamaha recommends a minimum operator age of 16 years old. Adults must supervise use by minors. Know your local operator age and training requirements.
- This watercraft is designed to carry the operator and up to 2 passengers. Never exceed the maximum load limit or allow more than 3 persons (or 2 persons if a wakeboarder or water-skier is being pulled) to ride the watercraft at any time.



Maximum load:
240 kg (530 lb)
Load is the total weight of cargo, operator, and passengers.

- Do not operate the watercraft with any passengers on board until you have considerable practice and experience riding alone. Operating the watercraft with passengers requires more skill. Take the time to become accustomed to the handling characteristics of the watercraft before trying any difficult maneuvers.

Safety information

EJU43321

Cruising limitations

- Scan constantly for people, objects, and other watercraft. Be alert for conditions that limit your visibility or block your vision of others.

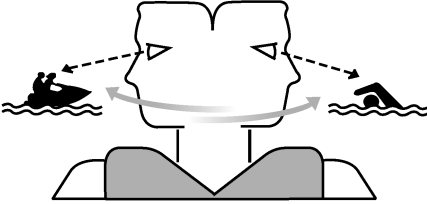

- Operate defensively at safe speeds and keep a safe distance away from people, objects, and other watercraft.
- Do not follow directly behind watercraft or other boats.
- Do not go near others to spray or splash them with water.
- Take early action to avoid collisions. Remember, watercraft and other boats do not have brakes. In addition, the Reverse with Intuitive Deceleration Electronics (RiDE) system is not a braking device for avoiding dangerous situations. The RiDE system is an electronic system for controlling the engine speed and reverse gate, which is located near the jet thrust nozzle. The RiDE lever located at the left handlebar grip can be used to change the direction of the jet thrust so that the watercraft moves in reverse or is in neutral. The RiDE system assists the operator when slowing down and during slow-speed maneuvering, such as launching, beaching, and docking.
- Avoid sharp turns, slowing down rapidly by squeezing the RiDE lever forcefully, and other maneuvers that make it hard for others to avoid you or understand where you are going.
- Avoid areas with submerged objects or shallow water.
- Do not release the throttle lever when trying to steer away from objects—you need throttle to steer. Always check throttle and steering controls before starting the watercraft.
- Ride within your limits and avoid aggressive maneuvers to reduce the risk of loss of control, ejection, and collision.
- This is a high performance boat—not a toy. Sharp turns or jumping wakes or waves can increase the risk of back/spinal injury (paralysis), facial injuries, and broken legs, ankles, and other bones. Do not jump wakes or waves.
- Do not operate the watercraft in rough water, bad weather, or when visibility is poor; this may lead to an accident causing injury or death. Be alert to the possibility of adverse weather. Take note of weather forecasts and the prevailing weather conditions before setting out on your watercraft.
- As with any water sport, you should not operate your watercraft without someone else nearby. If you operate further than swimming distance from shore, you should be accompanied by another boat or watercraft, but make sure you stay a safe distance away. It's good, common sense.
- Never operate in water that is less than 60 cm (2 ft) deep from the bottom of the watercraft, otherwise you increase your

chance of hitting a submerged object, which could result in injury.

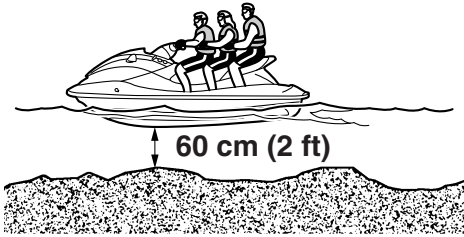

- This watercraft is not equipped with lighting required for night operation. Do not operate the watercraft after sunset or before dawn, otherwise you increase the risk of colliding with another boat, which could result in severe injury or death.



- Follow navigation rules, and state/provincial and local laws that apply to watercraft.

EJU43130

Operation requirements

- All riders must wear a personal flotation device (PFD) that is approved by the appropriate authorities and is suitable for personal watercraft use.
- Wear protective clothing. Severe internal injuries can occur if water is forced into body cavities as a result of falling into the water or being near the jet thrust nozzle. Normal swimwear does not adequately protect against forceful water entry into the rectum or vagina. All riders must wear a wetsuit bottom or clothing that provides equivalent protection. Such clothing includes thick, tightly woven, sturdy and snug-fitting apparel such as denim, but does not include spandex or similar fabrics, like those used in bicycle shorts.

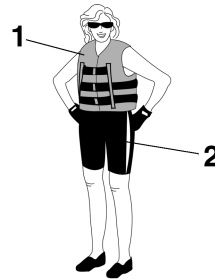

- 1 Authority-approved PFD
- 2 Wetsuit bottom

- Eye protection is recommended to keep wind, water, and glare from the sun out of your eyes while you operate your watercraft. Restraining straps for eyewear are made which are designed to float should your eyewear fall in the water. Footwear and gloves are recommended.
- You must decide whether to wear a helmet while you ride for recreation. You should know that a helmet could help protect you

Safety information

in certain kinds of accidents and that it could injure you in others.

A helmet is designed to provide some head protection. Although helmets cannot protect against all foreseeable impacts, a helmet might reduce your injuries in a collision with a boat or other obstacle.

A helmet may have potential safety hazards, as well. Falling into the water could risk the chance of the helmet catching water, commonly known as “bucketing”, and the resulting strain on your neck could cause choking, severe and permanent neck injuries, or death. A helmet could also increase the risk of an accident if it reduces your vision or hearing, or if it distracts you or increases your fatigue.

How should you decide if a helmet’s potential safety benefits outweigh its potential risks for you? Consider your particular riding conditions. Consider factors such as your riding environment and your riding style and ability. Also consider the likelihood of traffic congestion, and the water surface conditions.

If you decide to wear a helmet based upon your riding circumstances, choose one carefully. Look for a helmet designed for personal watercraft use, if possible. If you will be engaging in closed-course competition, follow the helmet requirements of the sanctioning organization.

- Never operate the watercraft after consuming alcohol or taking other drugs.
- For reasons of safety and proper care of the watercraft, always perform the pre-operation checks listed on page 65 before operating the watercraft.
- The operator should grip the handlebars firmly with both hands and the passengers should hold on firmly, either to the person

in front of them or to the handgrip provided.

- The operator and passengers should always keep their feet on the floor of the footwell when the watercraft is in motion. Lifting your feet increases the chances of losing your balance, or hitting objects outside the watercraft with your feet. Do not give a ride to children if their feet cannot reach the floor of the footwell.



- Never allow a passenger to ride in front of the operator.
- Always consult your doctor on whether it is safe for you to ride this watercraft if you are pregnant or in poor health.
- Do not attempt to modify this watercraft. Modifications to your watercraft may reduce safety and reliability, and render the watercraft unsafe or illegal for use.
- Attach the engine shut-off cord (lanyard) to your left wrist and keep it free from the handlebars so that the engine stops if you, the operator, fall off. After riding, remove the engine shut-off cord (lanyard) from the wa-

tercraft to avoid accidental starting or unauthorized use by children or others.

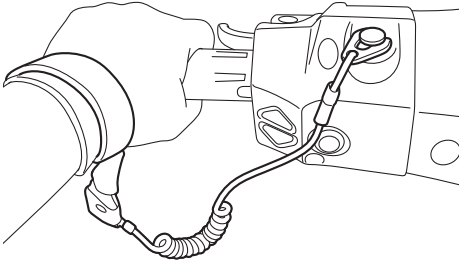

- Scan carefully for swimmers and stay away from swimming areas. Swimmers are hard to see and you could accidentally hit someone in the water.
- Avoid being hit by another boat. You should always take the responsibility to watch for traffic; other boaters may not be watching for you. If they do not see you, or if you maneuver more quickly than other boaters expect, you risk a collision.
- Maintain a safe distance from other boats and watercraft, and also watch for ski ropes or fishing lines. Obey the “Safe boating rules” and be sure to check behind you before making a turn or slowing down. (See “Safe boating rules” on page 19.)

EJU30841

Recommended equipment

The following items should be carried on board your watercraft:

- **Sound-signaling device**
You should carry a whistle or other sound-signaling device that can be used to signal other boats.
- **Visual distress signals**
It is recommended that a pyrotechnic device, which is approved by the appropriate authorities, be stored in a waterproof container on your watercraft. A mirror can also be used as an emergency signal. Contact a Yamaha dealer for more information.
- **Watch**
A watch is helpful so you will know how long you have been operating the watercraft.
- **Towline**
A towline can be used to tow a disabled watercraft in an emergency.

Safety information

EJU42474

Hazard information

- Never start the engine or let it run for any length of time in an enclosed area. Exhaust fumes contain carbon monoxide, a colorless, odorless gas that may cause loss of consciousness and death within a short time. Always operate the watercraft in an open area.
- Do not touch the hot muffler or engine during or immediately after engine operation; they can cause serious burns.
- Do not place magnets or objects with a strong magnetic force near the throttle lever or RiDE lever. The electronic throttle mechanism of the levers can be adversely affected, which could cause loss of control. In addition, do not place objects susceptible to magnetic forces (i.e., credit cards, watches, etc.) close to the throttle lever or RiDE lever.

EJU42414

Watercraft characteristics

- Jet thrust turns the watercraft. Releasing the throttle lever completely produces only minimum thrust. If you are traveling at speeds above trolling, you will have rapidly decreasing ability to steer without throttle. This model is equipped with the Yamaha Engine Management System (YEMS) that includes an off-throttle steering (OTS) system. It will activate at planing speeds should you attempt to steer the watercraft after releasing the throttle lever. The OTS system assists in turning by continuing to supply some thrust while the watercraft is decelerating, but you can turn more sharply if you apply throttle while turning the handlebars.
The OTS system does not function below planing speeds or when the engine is off. Once the engine slows down, the watercraft will no longer turn in response to handlebar input until you apply throttle again or you reach trolling speed.
Practice turning in an open area without obstacles until you have a good feel for this maneuver.
- This watercraft is water-jet propelled. The jet pump is directly connected to the engine. This means that jet thrust will produce some movement whenever the engine is running and the “F” (forward) or “R” (reverse) shift indicator is displayed in the multifunction display. When the “N” (neutral) shift indicator is displayed, the forward and reverse thrust are balanced to help keep the watercraft from moving in either

Safety information

direction, although some movement may occur.

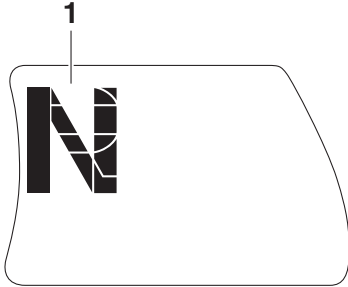

1 "N" (Neutral position)

- To avoid rear-end collisions while operating the watercraft, check behind you before using the RiDE lever to slow down or stop the watercraft. Make sure that there are no obstacles or people behind you before shifting into reverse.
- Keep away from the intake grate while the engine is on. Items such as long hair, loose clothing, or PFD straps can become entangled in moving parts, resulting in severe injury or drowning.
- Never insert any object into the jet thrust nozzle while the engine is running. Severe injury or death could result from coming in contact with the rotating parts of the jet pump.

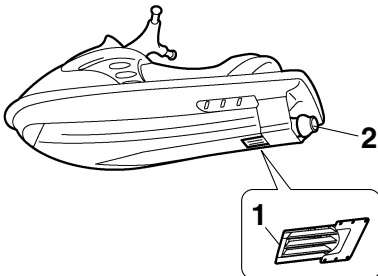

1 Intake grate
2 Jet thrust nozzle

- Stop the engine and remove the clip from the engine shut-off switch before removing any debris or weeds, which may have collected around the jet intake.

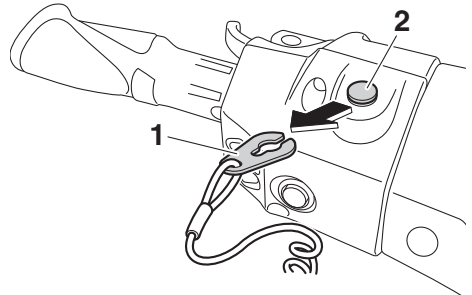

1 Clip
2 Engine shut-off switch

Safety information

EJU30956

Wakeboarding and water-skiing

You can use the watercraft for wakeboarding or water-skiing if it has the seating capacity to carry the operator, a rearward-facing spotter, and the wakeboarder or water-skier when he or she is not being pulled.

The watercraft must also have a cleat designed to pull a ski rope; do not attach the rope to any other location.

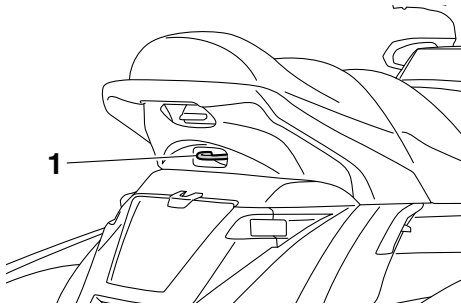

1 Cleat

It is the watercraft operator's responsibility to be alert to the safety of the wakeboarder or water-skier and others. Know and follow all local regulations in effect for the waters in which you will be operating.

The operator should be comfortable carrying passengers before attempting to pull a wakeboarder or water-skier.

The following are some important considerations for minimizing risks while pulling a wakeboarder or water-skier.

- The wakeboarder or water-skier should wear an approved PFD, preferably a brightly colored one so boat operators can see the person being pulled.
- The wakeboarder or water-skier should wear protective clothing. Severe internal injuries can occur if water is forced into body cavities as a result of falling into the water.

Normal swimwear does not adequately protect against forceful water entry into the rectum or vagina. The person being pulled should wear a wetsuit bottom or clothing that provides equivalent protection.

- A second person should be on board as a spotter to watch the wakeboarder or water-skier; in many places it is required by law. Let the person being pulled direct the operator's control of speed and direction with hand signals.

The spotter should sit astride the rear of the seat and hold onto the handgrip with both feet firmly on the floor of the footwell for proper balance while facing to the rear to watch the wakeboarder's or water-skier's hand signals and condition.

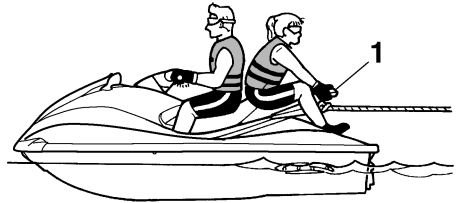

1 Handgrip

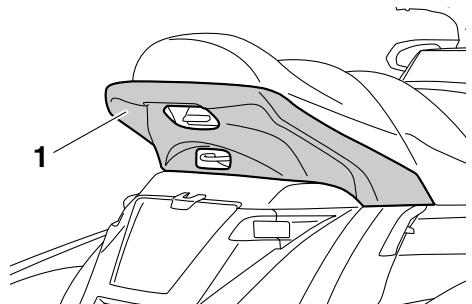

1 Handgrip

- Your control while pulling a wakeboarder or water-skier is affected by the wakeboard-

er's or water-skier's ability, as well as water and weather conditions.

- When preparing to pull a wakeboarder or water-skier, operate the watercraft at the slowest possible speed until the watercraft is well away from the person being pulled and slack in the ski rope is taken up. Make sure that the rope is not looped around anything.

After checking that the wakeboarder or water-skier is ready and that there is no traffic or other obstacles, apply enough throttle to raise the person.

- Make smooth, wide turns. The watercraft is capable of very sharp turns, which could exceed the abilities of the wakeboarder or water-skier. Keep the person being towed at least 50 m (164 ft), about twice the distance of a standard ski rope, away from any potential hazard.
- The operators of boats and other watercraft may not be aware that you are pulling a wakeboarder or water-skier. Together with the spotter, pay attention to others around you and cruise at safe speeds.
- Be alert to the hazard of the ski rope handle snapping back at the watercraft when the wakeboarder or water-skier falls or is unable to get up.
- Towing heavy or bulky objects other than wakeboarders or water-skiers, such as another boat or watercraft, can cause loss of steering control and create a hazardous condition. If you must tow another boat in an emergency situation, operate slowly and cautiously.

EJU30971

Safe boating rules

Your Yamaha watercraft is legally considered a powerboat. Operation of the watercraft must be in accordance with the rules and regulations governing the waterway on which it is used.

Safety information

EJU30992

Enjoy your watercraft responsibly

You share the areas you enjoy when riding your watercraft with others and with nature. So your enjoyment includes a responsibility to treat these other people, and the lands, waters, and wildlife with respect and courtesy.

Whenever and wherever you ride, think of yourself as the guest of those around you. Remember, for example, that the sound of your watercraft may be music to you, but it could be just noise to others. And the exciting splash of your wake can make waves others won't enjoy.

Avoid riding close to shoreline homes and waterfowl nesting areas or other wildlife areas, and keep a respectful distance from fishermen, other boats, swimmers, and populated beaches. When travel in areas like these is unavoidable, ride slowly and obey all laws.

Proper maintenance is necessary to ensure that the exhaust emission and sound levels of your watercraft will continue to be within regulated limits. You have the responsibility to make sure that the recommended maintenance in this owner's/operator's manual is carried out.

Remember, pollution can be harmful to the environment. Do not refuel or add oil where a spill could cause damage to nature. Remove your watercraft from the water and move it away from the shoreline before refueling. Dispose of water and any fuel and oil residue in the engine compartment according to local regulations. And keep your surroundings pleasant for the people and wildlife that share the waterways: don't litter.

When you ride responsibly, with respect and courtesy for others, you help ensure that our waterways stay open for the enjoyment of a variety of recreational opportunities.

EJU43331

Watercraft glossary

Trolling speed

“Trolling” is the lowest maneuvering speed. You are applying little or no throttle. The watercraft is down in the water, and there is no wake.

Sub-planing speed

“Sub-planing” is a medium speed. The bow of the watercraft is slightly up from the water surface, but you are still traveling through the water. There is a wake.

Planing speed

“Planing” is a faster speed. The watercraft is more level and is skimming on top of the water. There is a wake.

Bow

The front end of the watercraft.

Stern

The rear end of the watercraft.

Starboard

The right side of the watercraft when facing forward.

Port

The left side of the watercraft when facing forward.

Bilge water

Water that has collected in the engine compartment.

Yamaha Engine Management System (YEMS)

YEMS is an integrated, computerized management system that controls and adjusts ignition timing, fuel injection, engine diagnostics, and the off-throttle steering (OTS) system.

Reverse with Intuitive Deceleration Electronics (RiDE)

RiDE is an electronic system that controls the reverse, neutral, and deceleration operations of the watercraft.

Description

EJU31012

Location of main components

Exterior

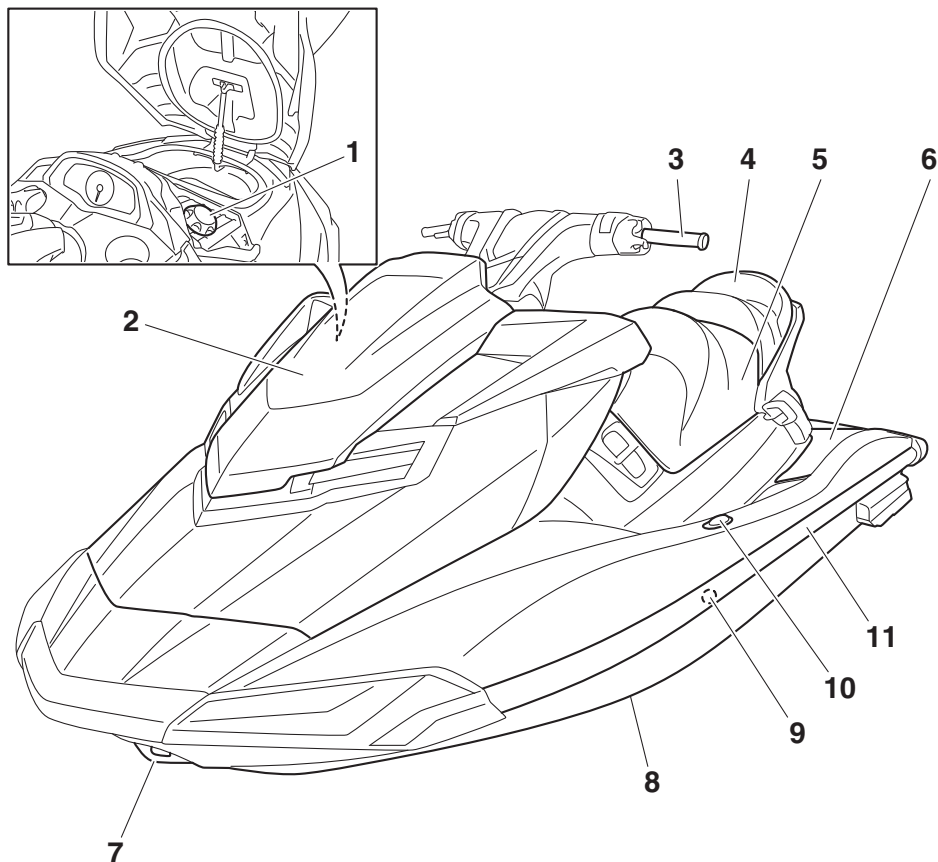

- 1 Fuel filler cap (page 58)
- 2 Hood
- 3 Handlebar
- 4 Rear seat (page 49)
- 5 Front seat (page 49)
- 6 Footwell
- 7 Bow eye (page 51)
- 8 Hull
- 9 Cooling water pilot outlet (page 31)
- 10 Pull-up cleat (FX Cruiser HO) (page 52)
- 11 Gunwale

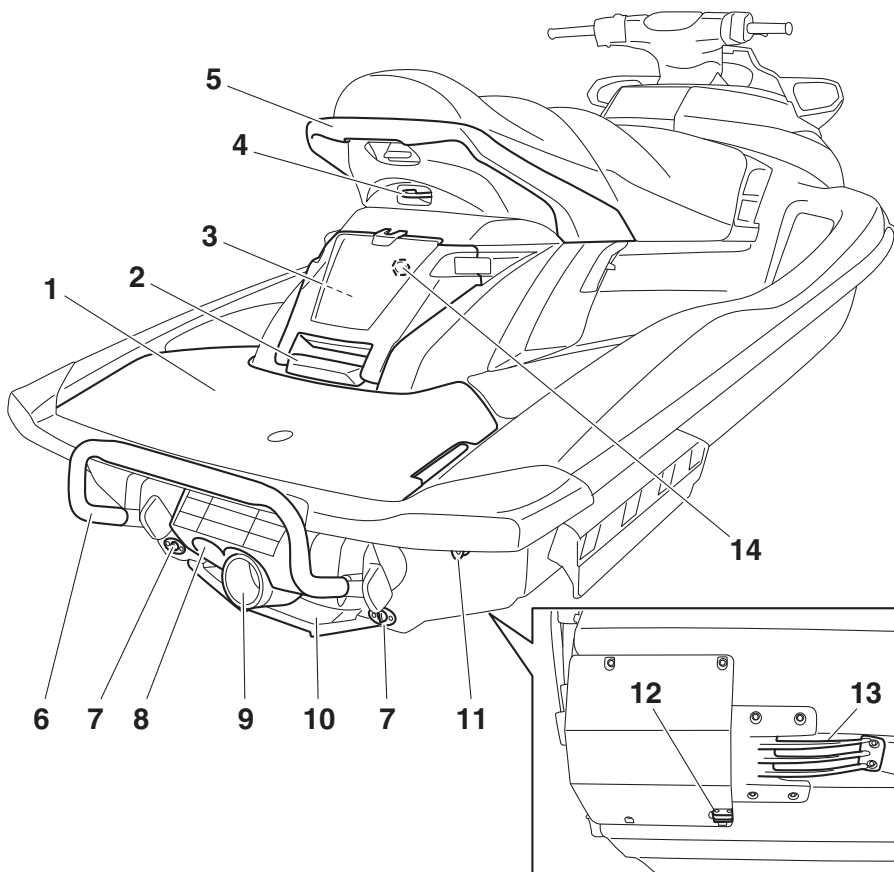

- 1 Boarding platform
- 2 Reboarding grip (page 50)
- 3 Stern storage compartment (page 54)
- 4 Cleat (page 51)
- 5 Handgrip (page 50)
- 6 Reboarding step (page 50)
- 7 Stern drain plug (page 62)
- 8 Reverse gate (page 32)
- 9 Jet thrust nozzle
- 10 Ride plate
- 11 Stern eye (page 51)
- 12 Speed sensor

- 13 Intake grate
- 14 Flushing hose connector

Description

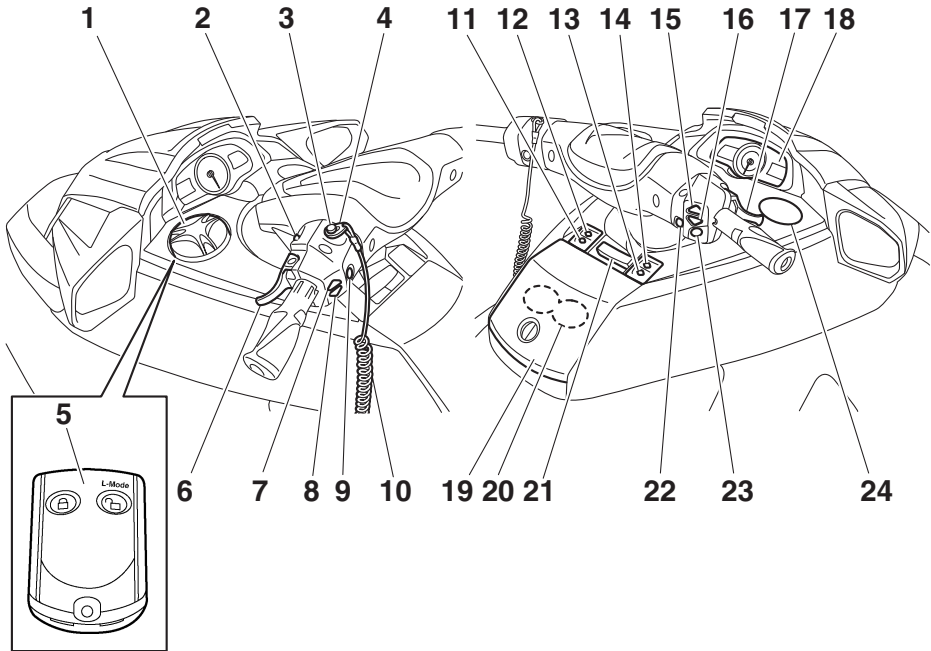

- 1** Built-in watertight storage compartment (page 55)
- 2** Start switch (page 28)
- 3** Engine shut-off switch (page 28)
- 4** Clip (page 28)
- 5** Remote control transmitter (page 26)
- 6** RiDE lever (page 32)
- 7** Electric trim up switch (page 34)
- 8** Electric trim down switch (page 34)
- 9** Engine stop switch (page 28)
- 10** Engine shut-off cord (lanyard) (page 28)
- 11** “VOLT/HOUR” button (page 40)
- 12** “SPEED/RPM” button (page 40)
- 13** “MODE/RESET” button (page 40)
- 14** “START/STOP” button (page 40)
- 15** Cruise assist up switch (page 38)
- 16** Cruise assist down switch (page 38)
- 17** Throttle lever (page 29)
- 18** Multifunction information center (page 40)
- 19** Glove compartment (page 53)
- 20** Removable beverage holder (page 55)
- 21** Tilt lever (page 30)
- 22** “NO-WAKE MODE” switch (page 37)
- 23** “SET” switch (page 38)
- 24** Built-in beverage holder (page 55)

Engine compartment

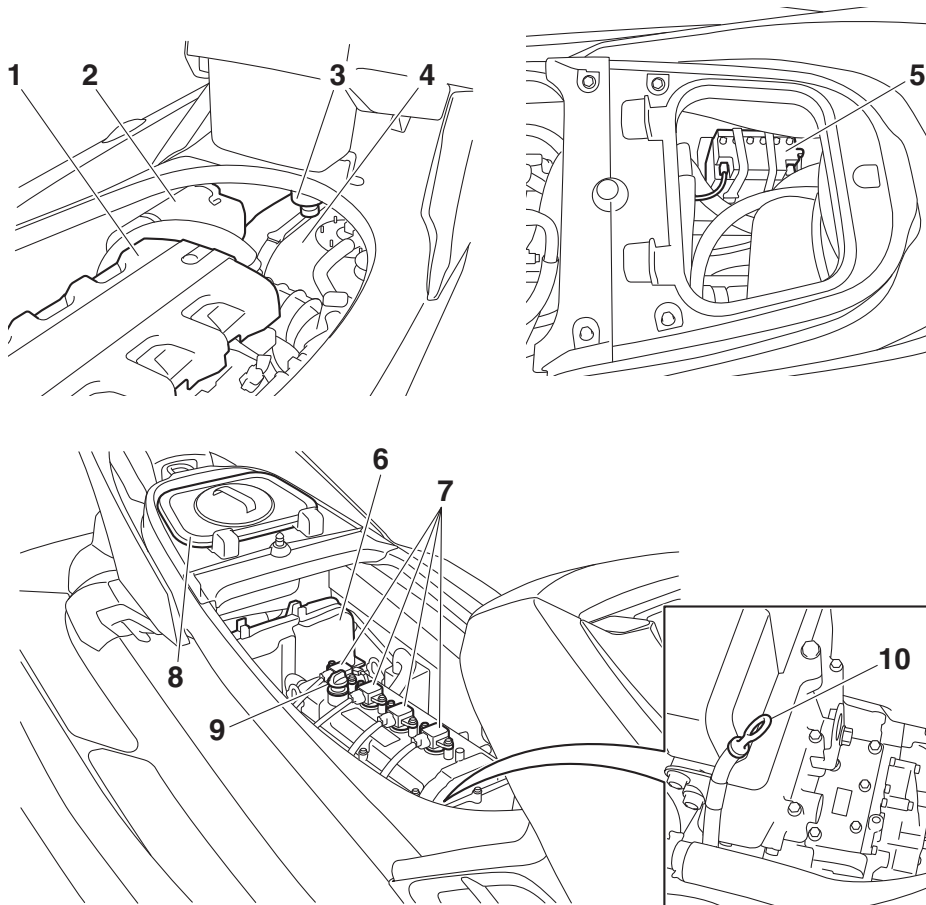

- 1 Engine cover
- 2 Air filter case
- 3 Water separator (page 31)
- 4 Fuel tank
- 5 Battery (page 68)
- 6 Electrical box
- 7 Spark plug/Ignition coil
- 8 Removable watertight storage compartment (page 55)
- 9 Engine oil filler cap (page 60)
- 10 Dipstick (page 60)

Control function operation

EJU31026

Watercraft control functions

EJU42551

Remote control transmitter

The Yamaha Security System and Low RPM Mode settings can be selected by operating the remote control transmitter. (See page 27 for Yamaha Security System setting procedures and page 36 for Low RPM Mode activation procedures.)

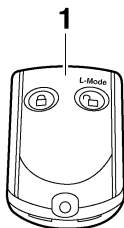

1 Remote control transmitter

Since the watercraft is programmed to recognize the internal code from this transmitter only, the settings can only be selected with this transmitter.

If you accidentally lose your remote control transmitter or if it is not operating properly, contact a Yamaha dealer.

When operating the watercraft, always keep the transmitter with you, such as by storing it in the transmitter holder in the built-in water-

tight storage compartment, so that it is not lost.

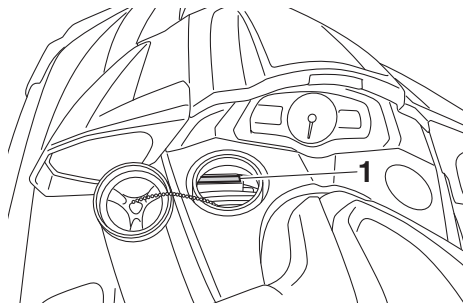

1 Transmitter holder

ECJ00753

NOTICE

- The remote control transmitter is not completely waterproof. Do not submerge the transmitter or operate it underwater. If the transmitter is submerged, dry it with a soft, dry cloth, and then check that it is operating properly. If the transmitter is not operating properly, contact a Yamaha dealer.
- Keep the remote control transmitter away from high temperatures and do not place it in direct sunlight.
- Do not drop the remote control transmitter, subject it to strong shocks, or place any heavy items on it.
- Use a soft, dry cloth to clean the remote control transmitter. Do not use detergent, alcohol, or other chemicals.
- Do not attempt to disassemble the remote control transmitter yourself. Otherwise, the transmitter may not operate properly. If the transmitter needs a new battery, contact a Yamaha dealer. Refer to local hazardous waste regulations when disposing of transmitter batteries.

Control function operation

EJU31385

Yamaha Security System

The Yamaha Security System functions to help prevent unauthorized use or theft of the watercraft. The lock and unlock modes of the security system can be selected by operating the remote control transmitter that is included with this watercraft. The engine cannot be started if the lock mode of the security system is selected. The engine can only be started if the unlock mode is selected. (See page 26 for information on the remote control transmitter.)

TIP:

The Yamaha Security System settings can only be selected while the engine is stopped.

EJU36776

Yamaha Security System settings

The Yamaha Security System settings will be confirmed by the number of beeps when the remote control transmitter is operated, and by the “UNLOCK” indicator light of the multifunction information center. (See page 40 for information on the multifunction information center.)

Number of beeps	Yamaha Security System mode	“UN-LOCK” indicator light
●	Lock	Goes off
● ●	Unlock (normal operation mode)	Comes on
● ● ●	Unlock (Low RPM Mode)	Comes on

TIP:

- The beeper sounds two times for the normal operation mode or three times for the Low RPM Mode. (See page 36 for Low RPM Mode activation procedures.)
- If the remote control transmitter is operated while the multifunction information center

is in the standby state, the center will perform the initial operation, and then the setting is selected.

To select the lock mode:

Push the lock button on the remote control transmitter briefly. The beeper sounds once and the “UNLOCK” indicator light blinks once, then goes off. This indicates the lock mode is selected.

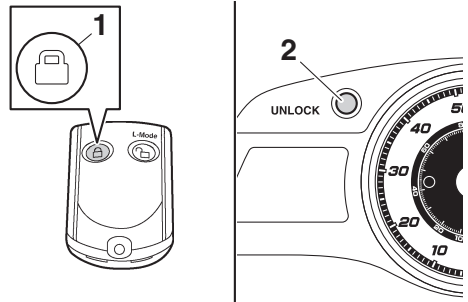

- 1 Lock button
- 2 “UNLOCK” indicator light

To select the unlock mode:

Push the “L-Mode” (unlock) button on the remote control transmitter briefly. The beeper sounds two or three times and the “UN-LOCK” indicator light blinks two or three times, then comes on. This indicates the unlock mode is selected.

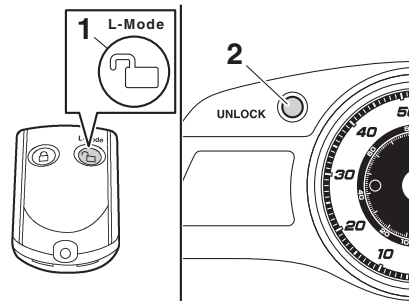

- 1 “L-Mode” (unlock) button
- 2 “UNLOCK” indicator light

Control function operation

EJU31153

Engine stop switch “”

The engine stop switch (red button) stops the engine when the switch is pushed.

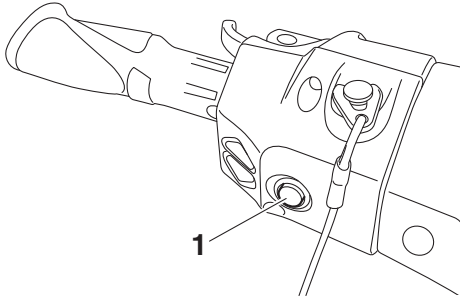

1 Engine stop switch

EJU31164

Engine shut-off switch “”

The engine shut-off switch automatically stops the engine when the clip, on the end of the engine shut-off cord (lanyard), is removed from the switch, such as if the operator falls off the watercraft.

Insert the clip under the engine shut-off switch before starting the engine.

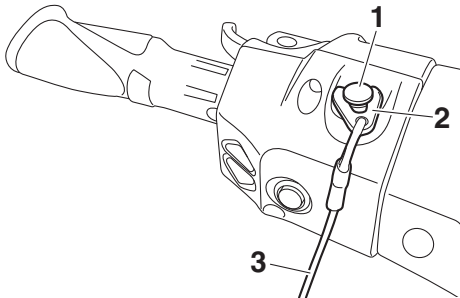

- 1 Engine shut-off switch
- 2 Clip
- 3 Engine shut-off cord (lanyard)

When the engine is not running, remove the clip from the engine shut-off switch to pre-

vent accidental starting or unauthorized operation by children or others.

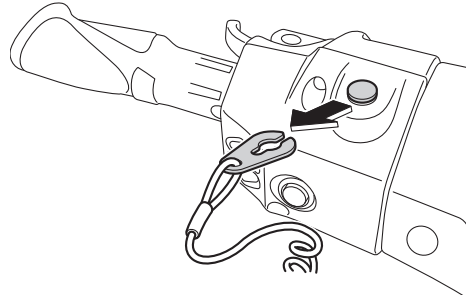

EJU42323

Start switch “”

ECJ01311

NOTICE

Do not run the engine over 4000 r/min on land. Also, do not run the engine for more than 15 seconds without supplying water, otherwise the engine could overheat.

The start switch (green button) starts the engine when the switch is pushed.

Release the start switch as soon as the engine starts to run. If the engine does not start in 5 seconds, release the start switch, wait 15 seconds, and then try again. **NOTICE: Never push the start switch while the engine is running. Do not operate the start switch for more than 5 seconds, otherwise the battery will be discharged and the engine**

Control function operation

will not start. Also, the starter motor could be damaged. [ECJ01041]

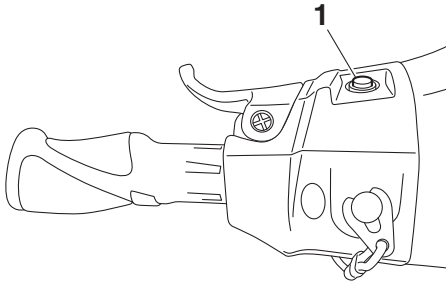

1 Start switch

The engine will not start under any of the following conditions:

- Lock mode of the Yamaha Security System has been selected. (See page 27 for Yamaha Security System setting procedures.)
- Clip is removed from the engine shut-off switch.
- Throttle lever is squeezed.
- Throttle lever is malfunctioning.
- RiDE lever is squeezed.
- RiDE lever is malfunctioning.

EJU31212

Throttle lever

The throttle lever increases the engine speed when the lever is squeezed.

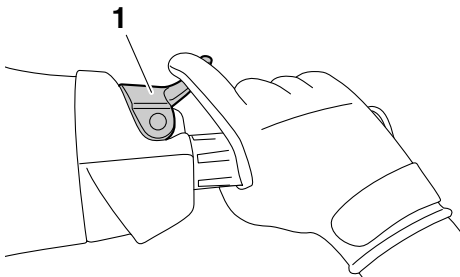

1 Throttle lever

The throttle lever returns automatically to its fully closed (idle) position when released.

EJU43341

RiDE lever

When the RiDE lever is squeezed, the reverse gate lowers and the watercraft starts moving in reverse. If the watercraft is moving forward, the watercraft gradually slows down until it stops, and then the watercraft starts moving in reverse.

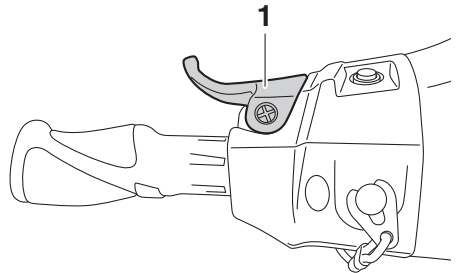

1 RiDE lever

When the RiDE lever is released, it automatically returns to its fully closed (idle) position and the reverse gate moves to the neutral position.

EJU31262

Steering system

By turning the handlebars in the direction you wish to travel, the angle of the jet thrust nozzle

Control function operation

zle is changed, and the direction of the watercraft is changed accordingly.

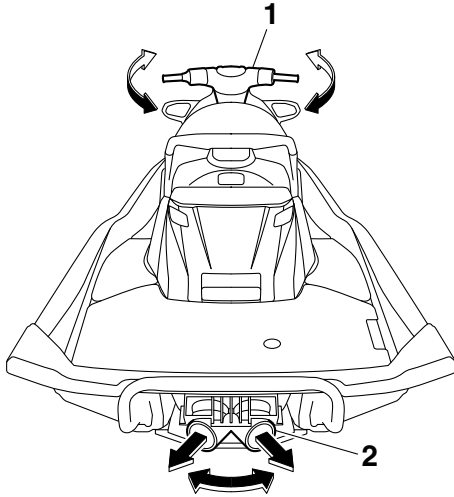

- 1 Handlebar
- 2 Jet thrust nozzle

Since the strength of the jet thrust determines the speed and degree of a turn, throttle must always be applied when attempting a turn, except at trolling speed.

This model is equipped with the Yamaha Engine Management System (YEMS) that includes an off-throttle steering (OTS) system. It will activate at planing speeds should you attempt to steer the watercraft after releasing the throttle lever. The OTS system assists in turning by continuing to supply some thrust while the watercraft is decelerating, but you can turn more sharply if you apply throttle while turning the handlebars. The OTS system does not function below planing speeds or when the engine is off. Once the engine slows down, the watercraft will no longer turn in response to handlebar input until you apply throttle again or you reach trolling speed.

EJU31294

Adjustable tilt steering system

The position of the handlebars can be adjusted back and forth by operating the tilt lever.

To adjust the handlebar position:

- (1) Pull the tilt lever up to disengage the handlebar lock, and then move the handlebars back or forth to the desired position.

WARNING! Never pull the tilt lever during operation, otherwise the handlebars may suddenly change position, which may lead to an accident. [EWJ00042]

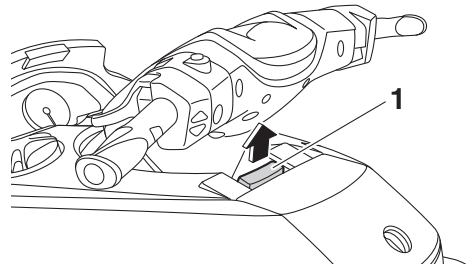

- 1 Tilt lever

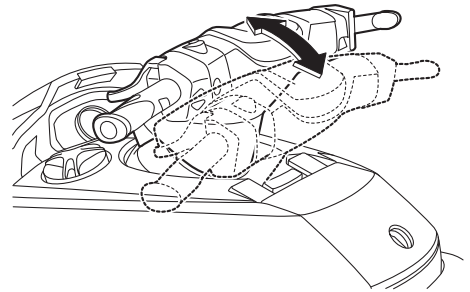

Control function operation

- (2) Make sure that the tilt lever returns to its original position and that the handlebars are securely locked in place.

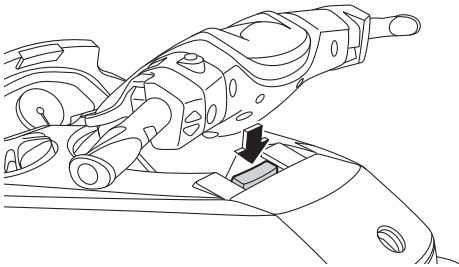

EJU35975

Cooling water pilot outlet

When the engine is running, some of the cooling water that is circulated in the engine is discharged from the cooling water pilot outlet.

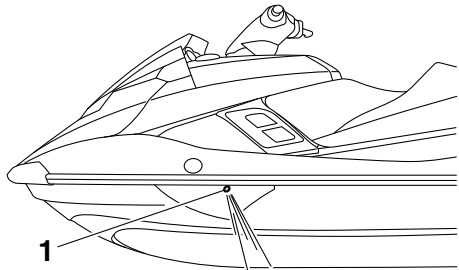

1 Cooling water pilot outlet

There is a cooling water pilot outlet on the port (left) side of the watercraft. To check for proper operation of the cooling system, make sure that water is being discharged from the cooling water pilot outlet. If water is not being discharged from the outlet, stop the engine and check the jet intake for clogging. (See page 102 for information on the jet intake.)

TIP:

- It will take about 60 seconds for the water to reach the outlet after the engine is started.
- Water discharge may not be constant when the engine is running at idling speed. If this occurs, apply a little throttle to make sure that water discharges properly.

EJU40323

Water separator

The water separator prevents water from entering the fuel tank by collecting any water that has entered the fuel tank breather hose if the watercraft was capsized.

If water has collected in the water separator, drain it by loosening the drain screw.

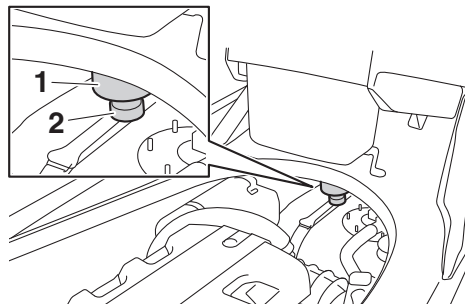

1 Water separator
2 Drain screw

To drain water from the water separator:

- (1) Place a drain pan or dry cloth under the water separator.
- (2) Gradually loosen the drain screw to drain the water. Catch the draining water in the drain pan or soak it up with the dry cloth so that it does not spill into the engine compartment. If any water spills into the watercraft, be sure to wipe it up with a dry cloth.
- (3) Securely tighten the drain screw until it stops.

Watercraft operation

EJU40013

Watercraft operation functions

EJU43153

Shift system

EWJ01773

WARNING

- Make sure that there are no obstacles or people behind you before shifting into reverse.
- Do not touch the reverse gate while the RiDE lever is being operated, otherwise you could be pinched.
- If the RiDE lever and throttle lever are being operated at the same time, do not release only the RiDE lever. Otherwise, the watercraft could accelerate more quickly than expected, which may lead to an accident.

The RiDE lever and throttle lever can be operated to change the forward or rearward movement of the watercraft only when the engine is running. When the RiDE lever is squeezed, the reverse gate lowers and deflects the water jet being discharged from the jet thrust nozzle so that the watercraft moves in reverse or is in neutral. When the throttle lever is squeezed, the reverse gate rises and the watercraft moves forward.

TIP:

- This model is equipped with a function which limits the engine speed in reverse.
- When the engine is started, the reverse gate automatically moves to the neutral position.

To shift into reverse:

- (1) Release the throttle lever.
- (2) Squeeze the RiDE lever. The reverse gate will lower, the engine speed will increase, the watercraft will start moving in

reverse, and the “R” (reverse) shift indicator will be displayed.

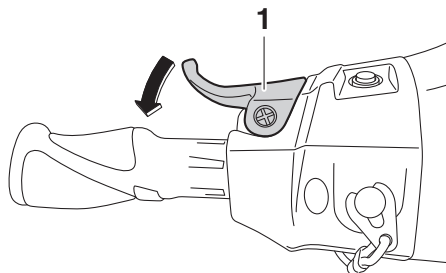

1 RiDE lever

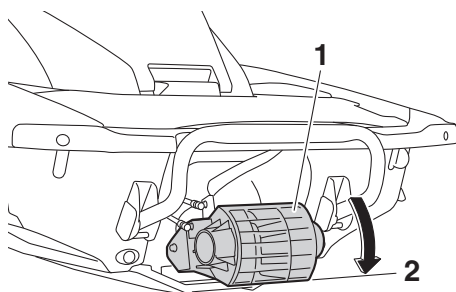

1 Reverse gate

2 Reverse position

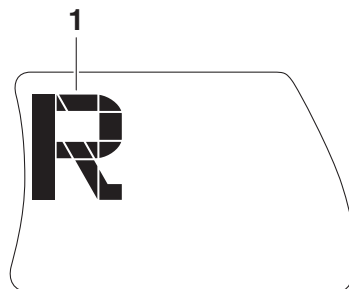

1 “R” (Reverse position)

To shift into neutral from reverse:

Release the RiDE lever. The reverse gate will automatically return to the neutral position

Watercraft operation

and the “N” (neutral) shift indicator will be displayed.

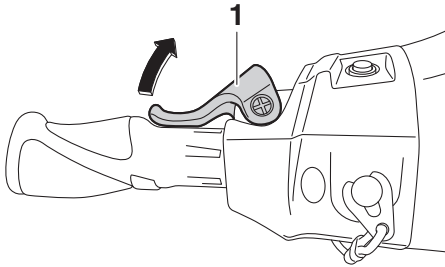

1 RiDE lever

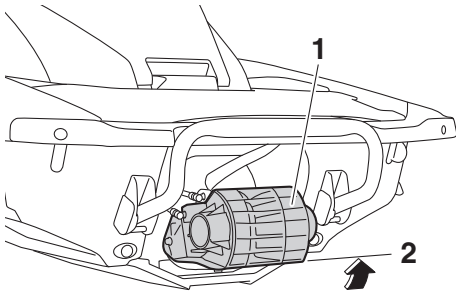

1 Reverse gate
2 Neutral position

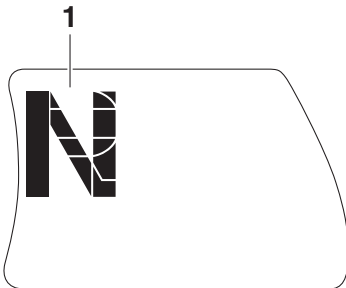

1 “N” (Neutral position)

TIP:

Although the neutral position helps keep the watercraft from moving even when the engine is running, some movement may occur.

To shift into forward:

- (1) Release the RiDE lever.
- (2) Squeeze the throttle lever. The reverse gate will rise completely, the engine speed will increase, the watercraft will start moving forward, and the “F” (forward) shift indicator will be displayed.

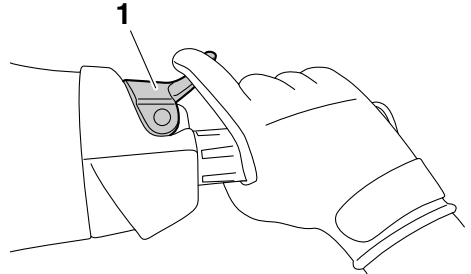

1 Throttle lever

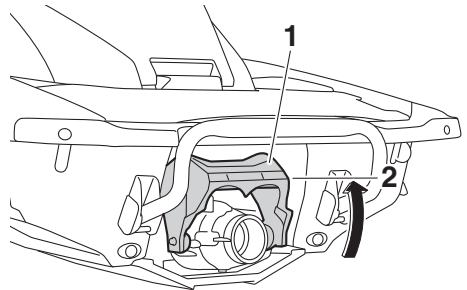

1 Reverse gate
2 Forward position

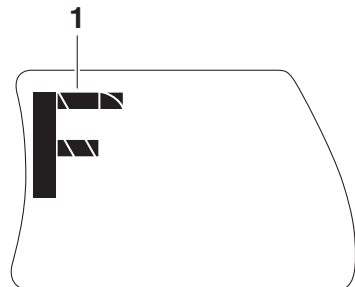

1 “F” (Forward position)

Watercraft operation

TIP:

If the RiDE lever is squeezed while the throttle lever is squeezed, the watercraft will slow down, and once stopped, move in reverse.

To shift into neutral from forward:

- (1) Release the throttle lever.
- (2) Lightly squeeze and release the RiDE lever. The “N” (neutral) shift indicator will be displayed.

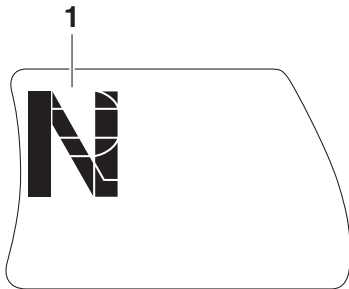
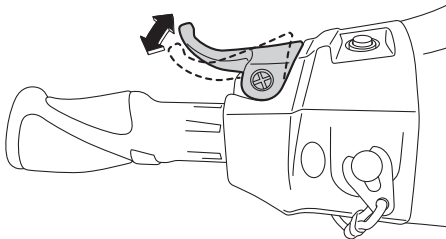

1 “N” (Neutral position)

TIP:

If the RiDE lever is squeezed continuously, the reverse gate will move to the reverse position.

EJU43161

Electric trim system

The electric trim up switch and electric trim down switch are located at the left handlebar grip and are operated to change the vertical angle of the jet thrust nozzle, which adjusts the trim angle of the watercraft. The switches

can be operated only when the engine is running.

There are 5 positions: neutral, 2 bow-down positions (a) and (b), and 2 bow-up positions (c) and (d).

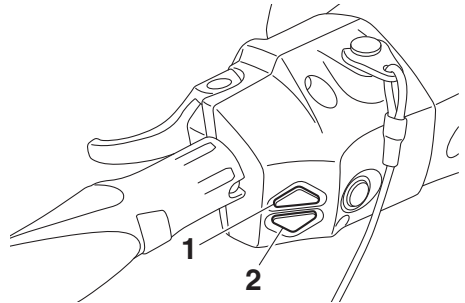

- 1 Electric trim up switch
- 2 Electric trim down switch

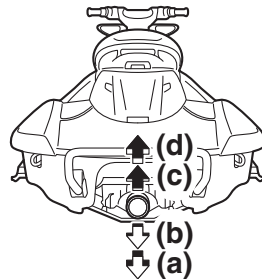
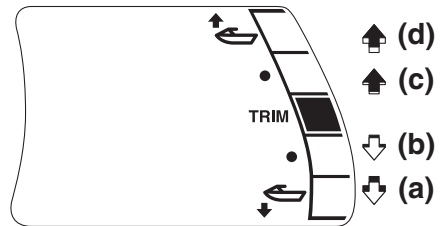

Bow-down positions (a) and (b)

The bow will go down, causing the trim angle to decrease.

Watercraft operation

Vertical movement of the bow will be reduced and the watercraft will get up on plane more quickly when accelerating.

Bow-up positions (c) and (d)

The bow will go up, causing the trim angle to increase.

There is less water resistance, therefore, straight-ahead acceleration is enhanced.

TIP:

The watercraft performance characteristics according to the trim angle change depending on the operating conditions.

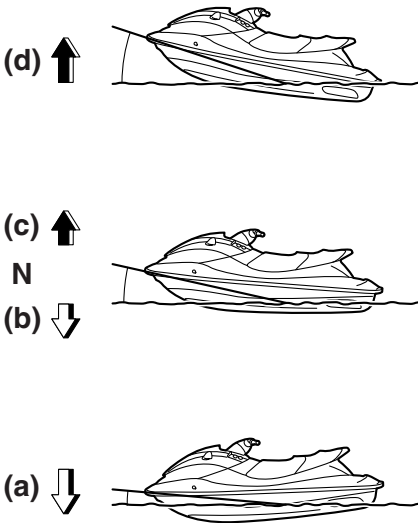

To change the trim angle:

- (1) If the reverse gate is in the neutral position, lightly squeeze the throttle lever so that the watercraft moves forward.

- (2) Push the electric trim up switch or electric trim down switch to select the desired trim angle.

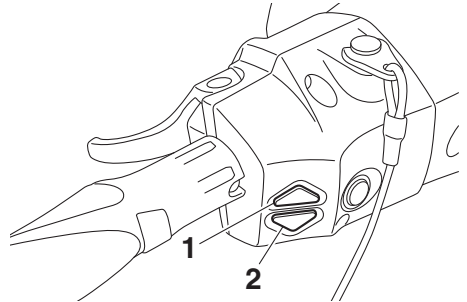

- 1 Electric trim up switch
- 2 Electric trim down switch

TIP:

- When the reverse gate moves to the neutral or reverse position, the jet thrust nozzle will automatically return to the neutral position. When the reverse gate moves to the forward position, the jet thrust nozzle will automatically change to the set trim angle.
- When the engine stops, the jet thrust nozzle returns to the neutral position.

Watercraft operation

EJU40001

Watercraft operation modes

EJU36787

Low RPM Mode

The Low RPM Mode is a function that limits the maximum engine speed to approximately 70% of the maximum engine speed in the normal mode.

The Low RPM Mode can only be activated and deactivated by operating the remote control transmitter that is included with this watercraft. (See page 26 for information on the remote control transmitter.)

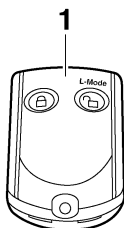

1 Remote control transmitter

TIP:

The Low RPM Mode can only be activated when the engine is stopped in the unlock mode of the Yamaha Security System.

Activating and deactivating the Low RPM Mode

Activation of the Low RPM Mode will be confirmed by the number of beeps when the remote control transmitter is operated, and by the “L-MODE” indicator light of the multifunction information center. (See page 40 for information on the multifunction information center.)

Number of beeps	Low RPM Mode operation	“L-MODE” indicator light
● ● ●	Activated	Comes on
● ●	Deactivated	Goes off

TIP:

If the remote control transmitter is operated while the multifunction information center is in the standby state, the center performs the initial operation, and then the setting is selected.

To activate the Low RPM Mode:

Push the “L-Mode” (unlock) button on the remote control transmitter for more than 4 seconds. Once the beeper sounds three times and the “UNLOCK” indicator light blinks three times, then comes on, the “L-MODE” indicator light comes on and the Low RPM Mode is activated.

TIP:

If the Low RPM Mode is activated immediately after the information display turns off, the “L-MODE” indicator light will not come on. The “L-MODE” indicator light will come on when the engine is started.

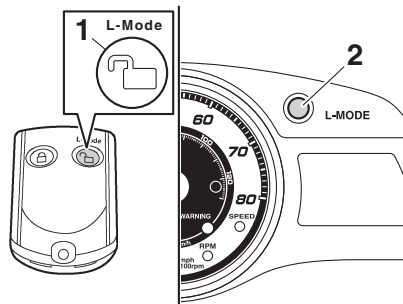

1 “L-Mode” (unlock) button

2 “L-MODE” indicator light

Watercraft operation

To deactivate the Low RPM Mode:

Push the “L-Mode” (unlock) button on the remote control transmitter for more than 4 seconds. Once the beeper sounds two times and the “UNLOCK” indicator light blinks two times, then comes on, the “L-MODE” indicator light goes off and the Low RPM Mode is deactivated. When the Low RPM Mode is deactivated, the watercraft returns to the normal operation mode.

EJU42484

No-wake mode

The no-wake mode is a function that maintains the engine speed at a fixed setting for operating the watercraft at low speeds. This function can be used only for forward watercraft operation or when the watercraft is in neutral.

TIP:

- The no-wake mode can only be activated after 5 seconds have elapsed since starting the engine.
- If the no-wake mode is activated when the watercraft is operating in neutral, the reverse gate will move to the forward position.

Activating and deactivating the no-wake mode

Activation of the no-wake mode will be confirmed by the number of beeps when the “NO-WAKE MODE” switch is pushed, and by the digital speedometer display of the multifunction information center. (See page 40 for information on the multifunction information center.)

Number of beeps	No-wake mode operation	Digital speedometer display
● ● ●	Activated	Starts blinking
● ●	Deactivated	Stops blinking

TIP:

The beeps and the blinking digital speedometer display also indicate the activation of the cruise assist. (See page 38 for information on the cruise assist.)

To activate the no-wake mode:

- (1) Release the throttle lever and let the engine speed return to idle.
- (2) Push and hold the “NO-WAKE MODE” switch. Once the beeper sounds three times quickly and “8” (when kilometers are selected) or “5” (when miles are selected) starts blinking in the digital speedometer display, the no-wake mode is activated. Keep the throttle lever in the fully closed (idle) position when the no-wake mode is activated.

TIP:

The digital speedometer display blinks continually while the no-wake mode is activated.

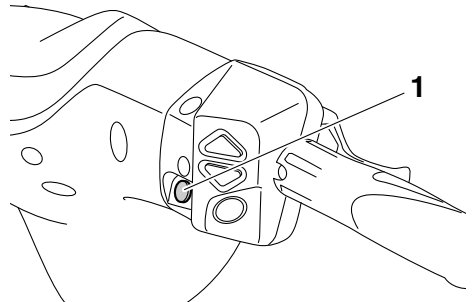

1 “NO-WAKE MODE” switch

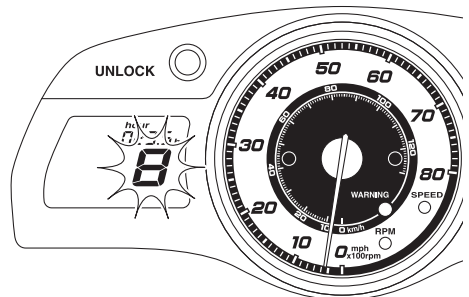

Watercraft operation

To deactivate the no-wake mode:

Perform one of the following operations. The beeper sounds two times quickly and the digital speedometer display stops blinking when the no-wake mode is deactivated.

- Push the “NO-WAKE MODE” switch.
- Squeeze the throttle lever.
- Squeeze the RiDE lever.

TIP:

The no-wake mode is also deactivated when the engine is stopped.

EJU37028

Cruise assist

The cruise assist is a function for maintaining a desired engine speed within a fixed range while operating the watercraft.

TIP:

- The cruise assist can only be set between engine speeds of approximately 3000 r/min and approximately 7000 r/min.
- The cruise assist cannot be activated in the Low RPM Mode. (See page 36 for Low RPM Mode activation procedures.)

Activating and deactivating the cruise assist

Activation of the cruise assist will be confirmed by the number of beeps when the “SET” switch, cruise assist up switch, or cruise assist down switch is pushed, and by the digital speedometer display of the multifunction information center. (See page 40 for information on the multifunction information center.)

Number of beeps	Cruise assist operation	Digital speedometer display
● ● ●	Activated	Starts blinking
● ●	Deactivated	Stops blinking
●	Set engine speed increases or decreases	Continues blinking

TIP:

The beeps and the blinking digital speedometer display also indicate the activation of the no-wake mode. (See page 37 for information on the no-wake mode.)

To activate the cruise assist:

- (1) Operate the throttle lever until the desired engine speed is reached.
- (2) When the engine speed reaches the desired cruise assist setting, push the “SET” switch. Once the beeper sounds three times quickly and the digital speedometer display starts blinking, the cruise assist is activated. When the cruise assist is activated, slowly squeeze the throttle lever to keep it squeezed further than the position at which the cruise assist was set; releasing the throttle lever will deactivate the cruise assist.

TIP:

The digital speedometer display blinks continually while the cruise assist is activated. Make sure that the beeper has sounded and the digital speedometer display is blinking before squeezing the throttle lever to the full throttle position. If the speedometer display is not blinking, the cruise assist is not activated

Watercraft operation

and the engine will respond normally to the throttle operation.

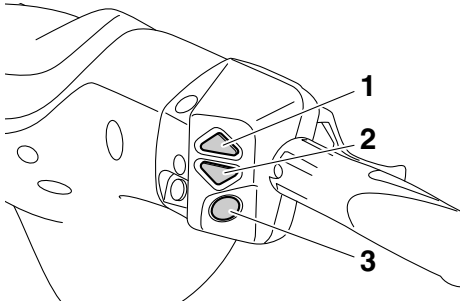

- 1 Cruise assist up switch
- 2 Cruise assist down switch
- 3 "SET" switch

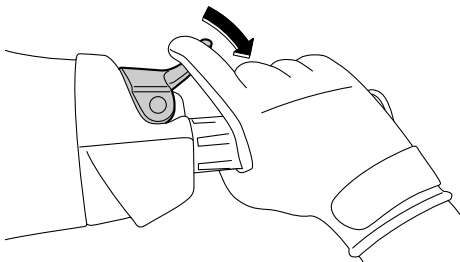
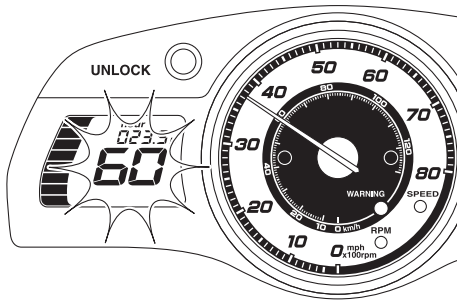

TIP:

Once the cruise assist is activated, the set engine speed can be increased by pushing the cruise assist up switch or decreased by pushing the cruise assist down switch. Each time a switch is pushed, the beeper will

sound one time quickly and the set engine speed will change. However, the adjustment is limited to a maximum of five increments above or below the initial cruise assist setting.

To deactivate the cruise assist:

Relax your grip on the throttle lever. The beeper sounds two times quickly and the digital speedometer display stops blinking when the cruise assist is deactivated.

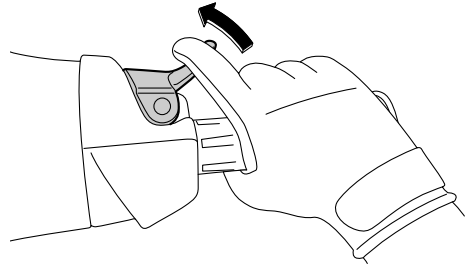

TIP:

The cruise assist is also deactivated when the engine is stopped.

Instrument operation

EJU42241

Multifunction information center

The multifunction information center displays various watercraft information.

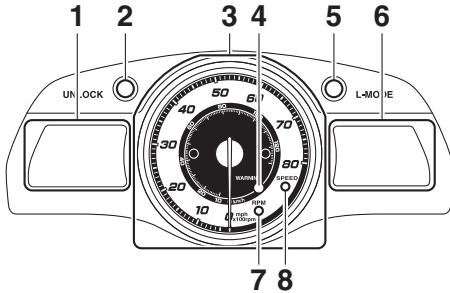

- 1 Information display
- 2 “UNLOCK” indicator light
- 3 Analog speedometer/tachometer
- 4 “WARNING” indicator light
- 5 “L-MODE” indicator light
- 6 Multifunction display
- 7 “RPM” indicator light
- 8 “SPEED” indicator light

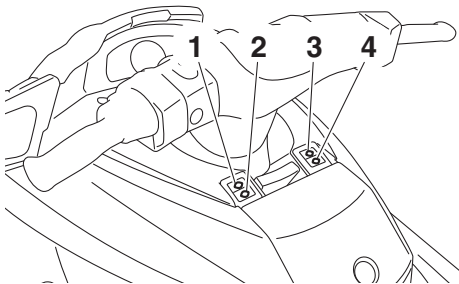

- 1 “SPEED/RPM” button
- 2 “VOLT/HOUR” button
- 3 “START/STOP” button
- 4 “MODE/RESET” button

Multifunction information center initial operation

When the multifunction information center is activated, the analog speedometer/tachometer makes one sweep, and all of the display

segments and indicator lights come on. After 2 seconds, the “WARNING” indicator light and the warning indicators in the information display go off, and then the center starts to operate normally.

TIP:

The “UNLOCK” indicator light will go off when the engine is started.

Multifunction information center standby state

If the multifunction information center does not receive any operation input within 25 seconds after the engine stops, the center will turn off and enter a standby state. When the engine is started again, the displays return to their state before the center turned off, and then the center starts to operate normally.

EJU42331

Analog speedometer/tachometer

The analog speedometer/tachometer has both a speedometer function and a tachometer function. By switching the meter, it can be used as either a speedometer or a tachometer.

TIP:

The analog tachometer is selected at the Yamaha factory.

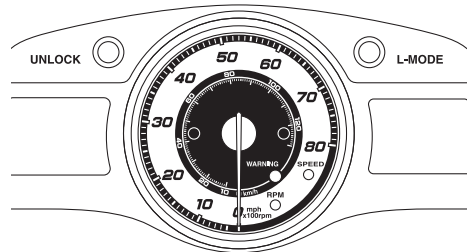

Analog tachometer

The analog tachometer shows the engine speed.

Instrument operation

The large outer numbers on the meter show the engine speed $\times 100$ rpm (r/min).

The “RPM” indicator light comes on when the analog tachometer is selected.

To switch to the tachometer from the speedometer:

Push the “SPEED/RPM” button for at least 1 second after the multifunction information center is activated. When the meter switches to the analog tachometer function, the “RPM” indicator light comes on.

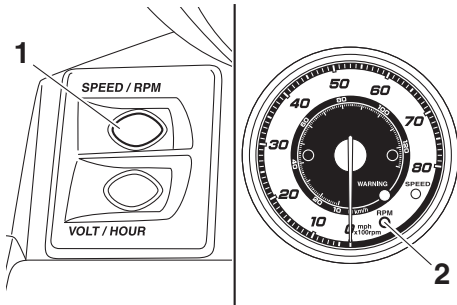

- 1 “SPEED/RPM” button
- 2 “RPM” indicator light

Analog speedometer

The analog speedometer shows the watercraft speed against water.

The small inner numbers on the meter show the watercraft speed in kilometers per hour “km/h” and the large outer numbers show the speed in miles per hour “mph”.

The “SPEED” indicator light comes on when the analog speedometer is selected.

To switch to the speedometer from the tachometer:

Push the “SPEED/RPM” button for at least 1 second after the multifunction information center is activated. When the meter switches to the analog speedometer function, the “SPEED” indicator light comes on if “km/h” are selected as the display units. The “SPEED” indicator light blinks three times,

then comes on, if “mph” are selected as the display units. (See page 41 for information on switching the digital speedometer display units.)

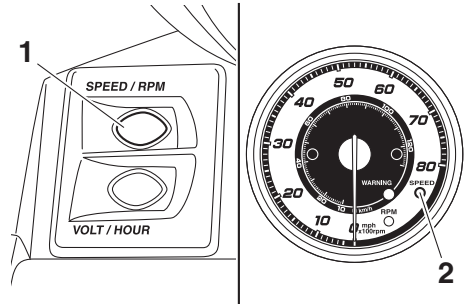

- 1 “SPEED/RPM” button
- 2 “SPEED” indicator light

EJU35027

Information display

The information display shows watercraft operating conditions.

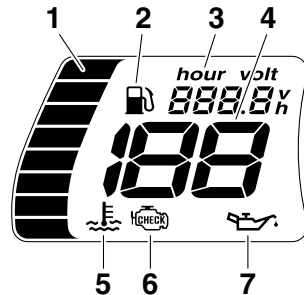

- 1 Fuel level meter
- 2 Fuel indicator
- 3 Hour meter/voltmeter
- 4 Digital speedometer
- 5 Engine overheat warning indicator
- 6 Check engine warning indicator
- 7 Oil pressure warning indicator

EJU42361

Digital speedometer

The digital speedometer shows the watercraft speed against water.

Instrument operation

By switching the display units, the speed can be shown in kilometers per hour (km/h) or miles per hour (mph).

TIP:

Miles are selected as the display units at the Yamaha factory.

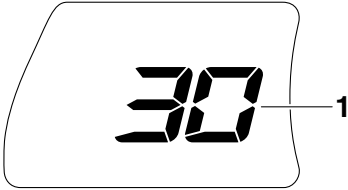

1 Digital speedometer

Digital speedometer display (mph)

The “SPEED” indicator light blinks three times when the multifunction information center is activated.

TIP:

If the analog speedometer is selected, the “SPEED” indicator light blinks three times, then comes on.

Digital speedometer display (km/h)

The “SPEED” indicator light blinks once if kilometers are selected as the display units when the multifunction information center is activated.

TIP:

If the analog speedometer is selected, the “SPEED” indicator light blinks once, then comes on.

To switch the digital speedometer display units:

Push the “VOLT/HOUR” button for at least 1 second, within 10 seconds after the multifunction information center is activated. The digital speedometer display changes. When

the display units are switched from kilometers to miles only, the “SPEED” indicator light blinks three times.

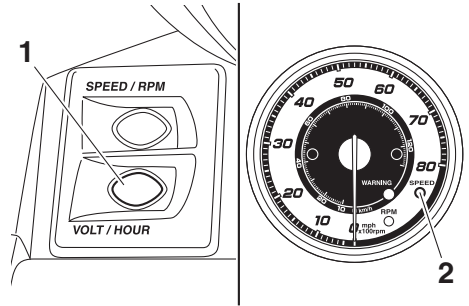

- 1 “VOLT/HOUR” button
- 2 “SPEED” indicator light

TIP:

The display units can also be switched by pushing the “START/STOP” button and “MODE/RESET” button simultaneously for at least 8 seconds.

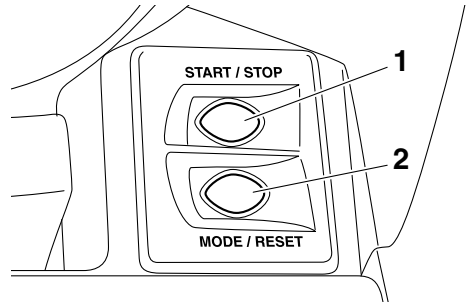

- 1 “START/STOP” button
- 2 “MODE/RESET” button

EJU42261

Hour meter/voltmeter

The hour meter/voltmeter has both an hour meter function and a voltmeter function. By switching the meter, it can be used as either an hour meter or a voltmeter.

Instrument operation

TIP:

The hour meter is selected at the Yamaha factory.

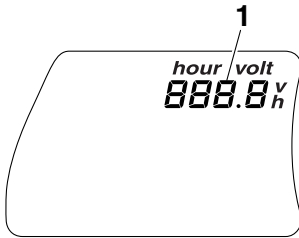

1 Hour meter/voltmeter

Hour meter

The hour meter shows the total number of hours that the engine has been running since the watercraft was new.

TIP:

The elapsed time will be kept even if the battery terminals have been disconnected.

To switch to the hour meter from the voltmeter:

Push the "VOLT/HOUR" button for at least 1 second after the multifunction information center is activated for more than 10 seconds. The display switches to the hour meter from the voltmeter.

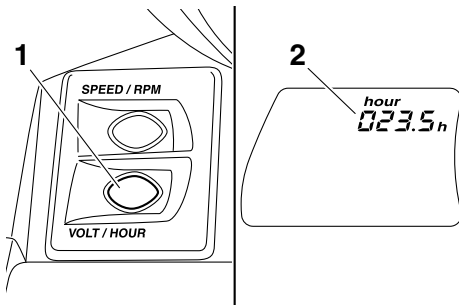

1 "VOLT/HOUR" button
2 Hour meter

Voltmeter

The voltmeter shows the battery voltage. When the battery voltage is normal, the voltmeter displays approximately 12 volts. If the battery voltage has dropped significantly, "LO" is displayed on the voltmeter. If the battery voltage has risen significantly, "HI" is displayed. If "LO" or "HI" is displayed, immediately return to shore and have a Yamaha dealer service the watercraft.

To switch to the voltmeter from the hour meter:

Push the "VOLT/HOUR" button for at least 1 second after the multifunction information center is activated for more than 10 seconds. The display switches to the voltmeter from the hour meter.

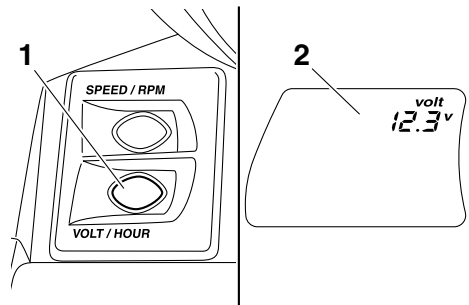

1 "VOLT/HOUR" button
2 Voltmeter

EJU31515

Fuel level meter

The fuel level meter shows the amount of fuel remaining in the fuel tank. The amount of remaining fuel is shown using eight display segments, which disappear two at a time as the fuel level decreases.

Instrument operation

TIP:

The accuracy of the fuel level meter varies depending on the operating conditions. Use this function as a reference only.

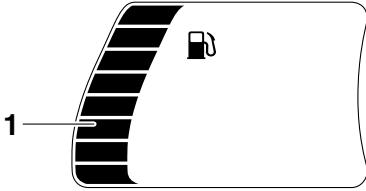

1 Fuel level meter

EJU42342

Fuel level warning

If the fuel remaining in the fuel tank drops to about 18 L (4.8 US gal, 4.0 Imp.gal), the lowest two fuel level segments, the fuel indicator, and the “WARNING” indicator light blink, and the buzzer sounds intermittently.

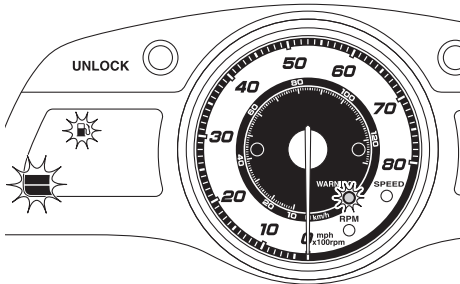

If the fuel level warning is activated, refill the fuel tank as soon as possible. (See page 58 for information on filling the fuel tank.)

After the fuel tank is refilled, the warning signals will be cleared when the engine is re-started.

TIP:

Push any of the operation buttons for the multifunction information center to stop the buzzer.

EJU42271

Oil pressure warning

If the oil pressure drops significantly, the oil pressure warning indicator and the “WARNING” indicator light blink, and the buzzer sounds intermittently. At the same time, the engine speed is limited.

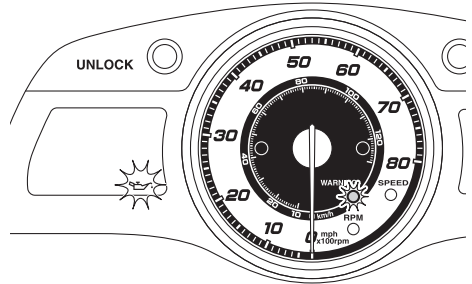

If the oil pressure warning is activated, immediately reduce the engine speed, return to shore, and then check the engine oil level. (See page 60 for information on checking the engine oil level.) If the oil level is sufficient, have a Yamaha dealer check the watercraft.

TIP:

Push any of the operation buttons for the multifunction information center to stop the buzzer.

EJU42571

Engine overheat warning

If the engine temperature rises significantly, the engine overheat warning indicator and the “WARNING” indicator light blink, and the buzzer sounds intermittently. Then, the engine overheat warning indicator and the “WARNING” indicator light stop blinking and remain on, and the buzzer sounds continu-

Instrument operation

ously. At the same time, the engine speed is limited.

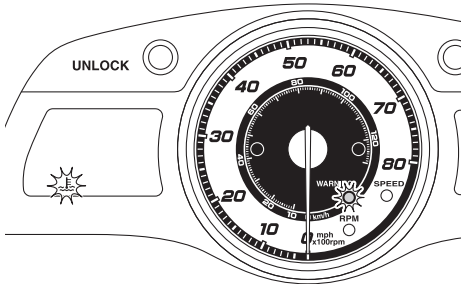

If the engine overheat warning is activated, immediately reduce the engine speed, return to shore, and then make sure that water is being discharged from the cooling water pilot outlet while the engine is running. If there is no discharge of water, stop the engine, and then check the jet intake for clogging. (See page 102 for information on the jet intake.)

NOTICE: If you cannot locate and correct the cause of the overheating, consult a Yamaha dealer. Continuing to operate at higher speeds could result in severe engine damage. [ECJ00042]

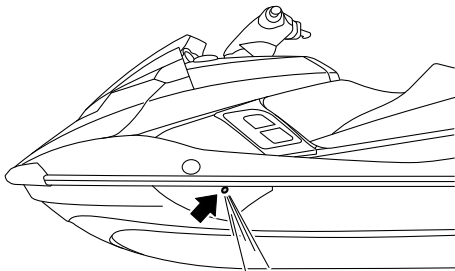

TIP:

Push any of the operation buttons for the multifunction information center to stop the buzzer.

EJU42281

Check engine warning

If a sensor malfunction or a short circuit is detected, the check engine warning indicator and the “WARNING” indicator light blink, and the buzzer sounds intermittently.

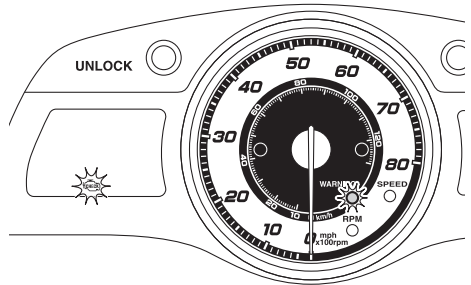

If the check engine warning is activated, immediately reduce the engine speed, return to shore, and have a Yamaha dealer check the engine.

TIP:

Push any of the operation buttons for the multifunction information center to stop the buzzer.

EJU43170

Multifunction display

The multifunction display shows various watercraft and environmental information, such

Instrument operation

as the shift position and jet thrust nozzle trim angle.

(reverse). (See page 32 for shifting procedures.)

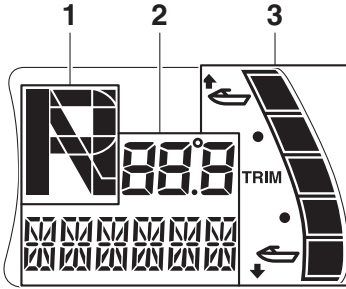

- 1 Shift indicator
- 2 Watercraft information
- 3 Trim indicator

The display units of the multifunction display are selected according to the display units of the digital speedometer. (To change the display units, see page 41 for digital speedometer display selection procedures.)

When “km/h” are selected as the display units of the digital speedometer, values are shown in kilometers/liters/degrees Celsius.

When “mph” are selected as the display units of the digital speedometer, values are shown in miles/gallons/degrees Fahrenheit.

EJU43180

Shift indicator

This indicator shows the reverse gate shift positions: “F” (forward), “N” (neutral), and “R”

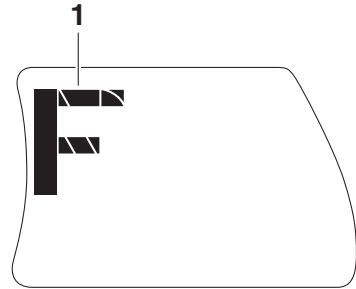

1 “F” (Forward position)

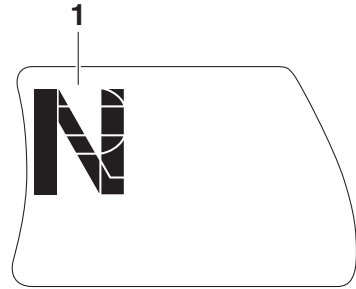

1 “N” (Neutral position)

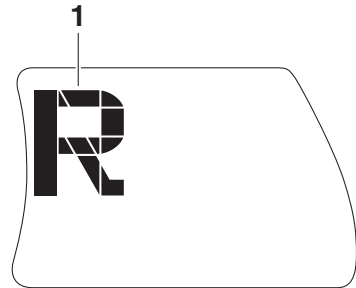

1 “R” (Reverse position)

EJU43190

Trim indicator

This indicator shows the trim angle of the jet thrust nozzle. One of the two upper display segments will be shown when the trim angle is increased, and one of the two lower display segments will be shown when the trim angle

Instrument operation

is decreased. When the neutral position of the jet thrust nozzle is selected, the middle display segment will be shown. (See page 34 for trim angle selection procedures.)

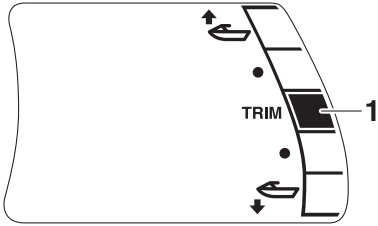

1 Trim indicator

EJU43520

Watercraft information

The multifunction display shows various watercraft and environmental information. To switch the display mode, push the "MODE/RESET" button for less than 1 second. The display mode changes in the following order.

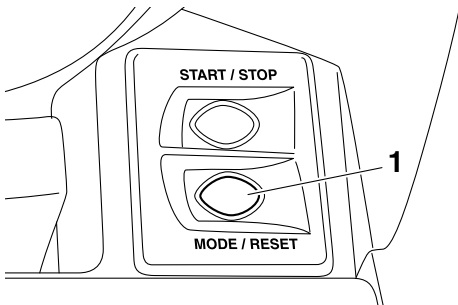

1 "MODE/RESET" button

Average speed

This display shows the average speed in kilometers per hour "AV KMH" or miles per hour

"AV MPH" since the measurement was started.

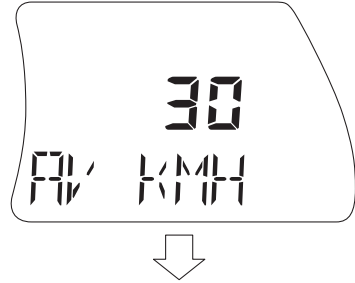

Tripmeter

This display shows the distance traveled in kilometers "KM" or miles "MILES" since the measurement was started.

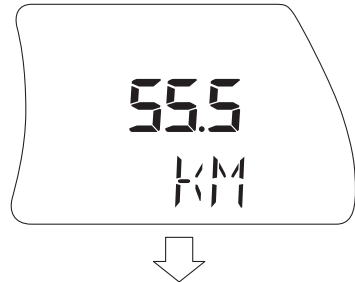

Fuel consumption per hour

This display shows the current fuel consumption in liters per hour "L/HR" or gallons per hour "G/HR".

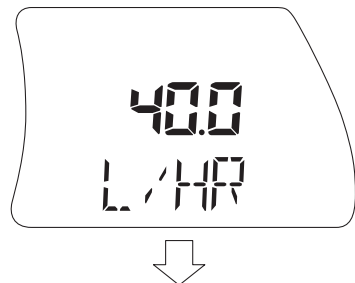

Instrument operation

Fuel consumption per kilometer/mile

This display shows the current fuel consumption in liters per kilometer “L/KM” or gallons per mile “G/MILE”.

TIP:

The actual fuel consumption varies greatly depending on the operating conditions. Use this function as a reference only.

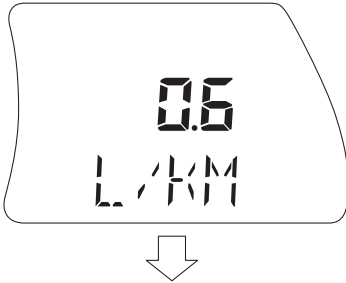

Average speed/Tripmeter modes

Average speed and distance traveled are recorded once the “START/STOP” button is pushed to start the measurements, regardless of the current display.

TIP:

The measurements are performed only while the engine is running.

The measurements are not saved if the engine is stopped. The measurements are reset

automatically when the displays go off 25 seconds after the engine stops.

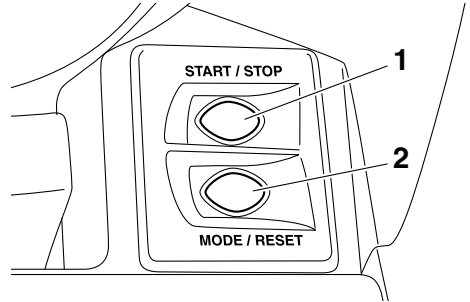

- 1 “START/STOP” button
- 2 “MODE/RESET” button

To start the measurements:

Push the “START/STOP” button for less than 1 second. The beeper sounds once and the measurements start.

To stop the measurements:

Push the “START/STOP” button for less than 1 second while the measurements are being recorded. The beeper sounds once and the measurements stop.

To restart the measurements:

Push the “START/STOP” button for less than 1 second while the measurements are stopped. The beeper sounds once and the measurements restart.

To reset the measurements:

Push the “MODE/RESET” button for at least 2 seconds while the measurements are stopped. The beeper sounds twice and the measurements are reset.

EJU40334

Equipment

EJU42203

Seats

The front and rear seats are removable.

Remove the seats to access the engine compartment and removable watertight storage compartment.

To remove the rear seat:

- (1) Pull the rear seat latch up, and then lift up the rear of the seat.

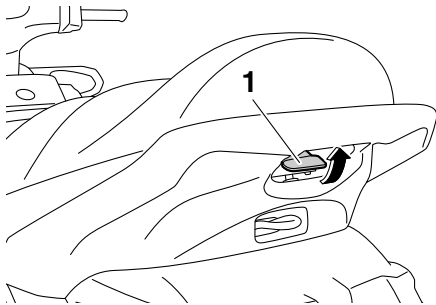

1 Seat latch

- (2) Pull the seat rearward and remove it.

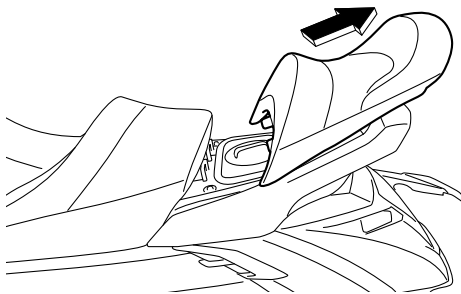

To install the rear seat:

- (1) Insert the projections on the front of the seat into the stays on the deck.



- (2) Push the rear of the seat down to securely lock it in place.

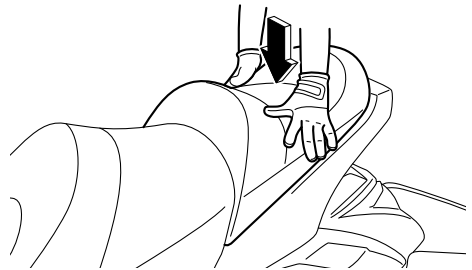

To remove the front seat:

- (1) Remove the rear seat.
- (2) Pull the front seat latch up, and then lift up the rear of the seat.

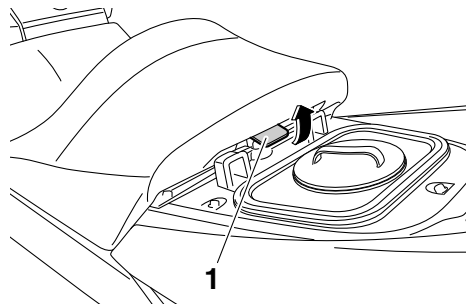

1 Seat latch

Equipment operation

- (3) Pull the seat rearward and remove it.

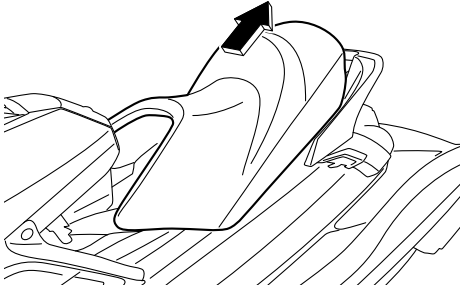

To install the front seat:

- (1) Insert the projection on the front of the seat into the stay on the deck.

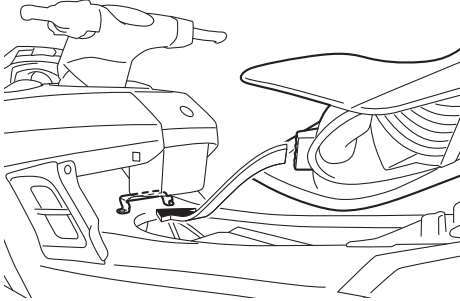

- (2) Push the rear of the seat down to securely lock it in place.

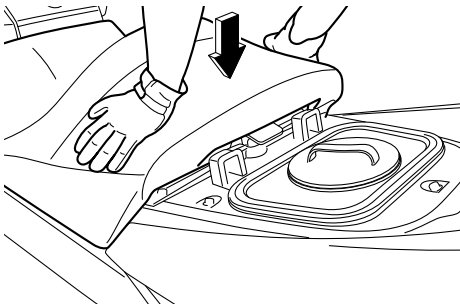

- (3) Securely install the rear seat in its original position.

EJU31364

Handgrip

The handgrip is used when boarding the watercraft from the water and when the spotter is facing rearward. **WARNING! Do not use the handgrip to lift the watercraft. The handgrip is not designed to support the watercraft's weight. If the handgrip breaks, the watercraft could fall, which could result in severe injury.** [EWJ00022]

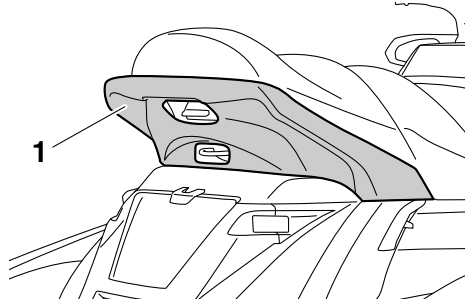

1 Handgrip

EJU37382

Reboarding grip

The reboarding grip is used when boarding the watercraft from the water.

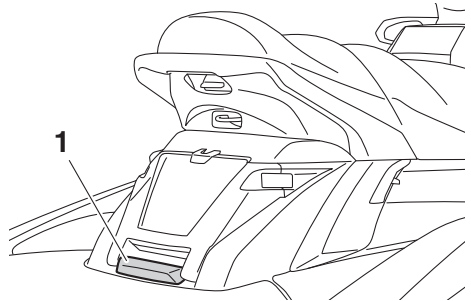

1 Reboarding grip

EJU34865

Reboarding step

The reboarding step is used to assist in reboarding the watercraft from the water. When boarding the watercraft, push the reboarding step down until it stops. The step returns automatically to its original position.

Equipment operation

when released. **WARNING! Do not use the reboarding step to lift the watercraft. The reboarding step is not designed to support the watercraft's weight. If the reboarding step breaks, the watercraft could fall, which could result in severe injury.** [EWJ01212]

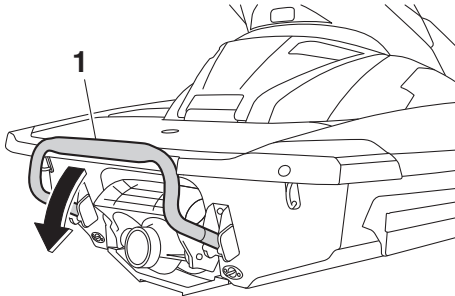

1 Reboarding step

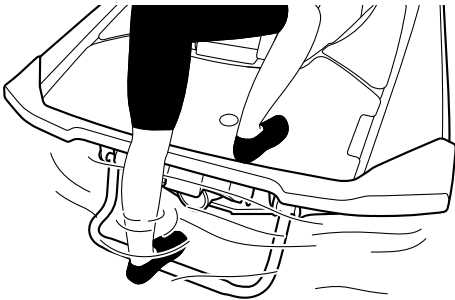

ECJ00743

NOTICE

Use the reboarding step only to board the watercraft in the water. Do not use the reboarding step for any other purpose. The watercraft can be damaged.

EJU34873

Bow eye

The bow eye is used to attach a rope to the watercraft when transporting, mooring, or

towing it in an emergency. (See page 106 for information on towing the watercraft.)

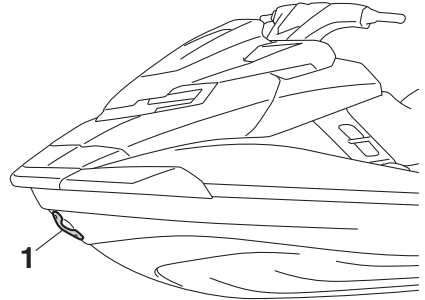

1 Bow eye

EJU34882

Stern eyes

The stern eyes are used to attach a rope to the watercraft when transporting or mooring it.

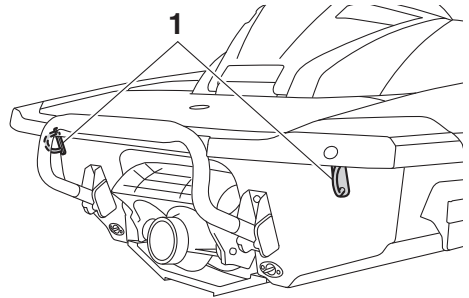

1 Stern eye

EJU40422

Cleat

The cleat is used to attach a ski rope to the watercraft when pulling a wakeboarder or water-skier. **WARNING! Do not use the cleat to lift the watercraft. The cleat is not designed to support the watercraft's weight. If the cleat breaks, the watercraft**

Equipment operation

could fall, which could result in severe injury. [EWJ01511]

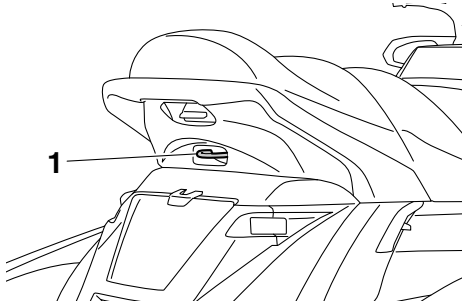

1 Cleat

EJU34893

Pull-up cleats (FX Cruiser HO)

The pull-up cleats are used to attach a rope to the watercraft when mooring it.

To use a pull-up cleat, pull it up. The pull-up cleat returns automatically to its original position when released. **WARNING! Do not use the pull-up cleats to lift the watercraft. The pull-up cleats are not designed to support the watercraft's weight. If the pull-up cleats break, the watercraft could fall, which could result in severe injury.** [EWJ00822]

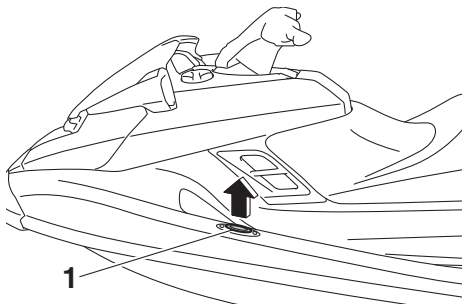

1 Pull-up cleat

EJU42291

Storage compartments

This watercraft is equipped with the following storage compartments.

Only the securely closed watertight storage compartments are waterproof. If you carry

objects that must be kept dry, put them in a waterproof bag.

Make sure that the storage compartments are closed securely before operating the watercraft.

EJU42211

Bow storage compartment

The bow storage compartment is located under the hood.

To open the bow storage compartment:

Pull the hood latch rearward, and then lift up the rear of the hood.

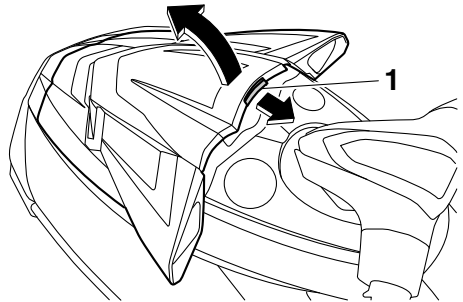

1 Hood latch

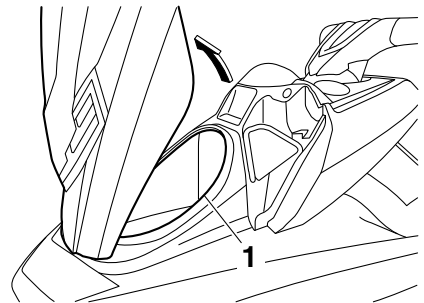

1 Bow storage compartment

Bow storage compartment:

Capacity:

90.0 L (23.8 US gal, 19.8 Imp.gal)

Load limit:

5.0 kg (11 lb)

Equipment operation

To close the bow storage compartment:

Push the rear of the hood down to securely lock it in place.

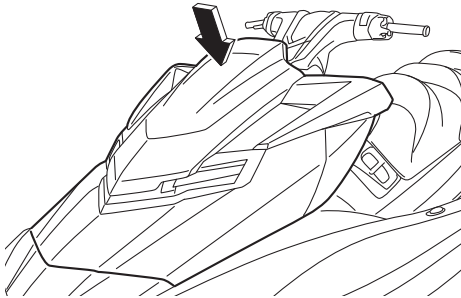

To drain water from the bow storage compartment:

- (1) Remove the drain plug on the bottom of the storage compartment to drain the water into the engine compartment.

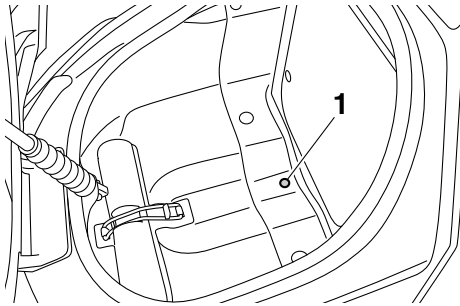

1 Drain plug

- (2) Securely install the drain plug in its original position.

EJU35164

Glove compartment

The glove compartment is located in front of the seat.

To open the glove compartment:

Turn the glove compartment knob 90° to the left or right, and then lift up the lid.

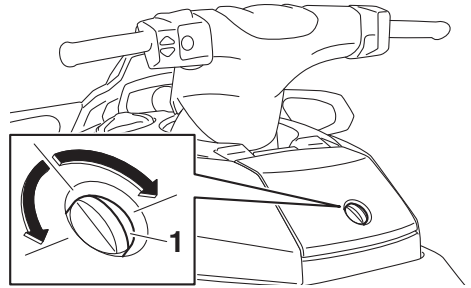

1 Glove compartment knob

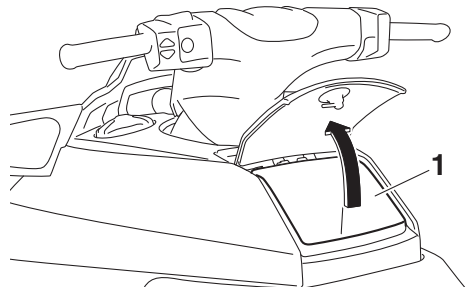

1 Glove compartment

Glove compartment:

Capacity:

7.0 L (1.8 US gal, 1.5 Imp.gal)

Load limit:

1.0 kg (2 lb)

Equipment operation

To close the glove compartment:

Lower the lid, and then turn the glove compartment knob to securely lock the lid in place.

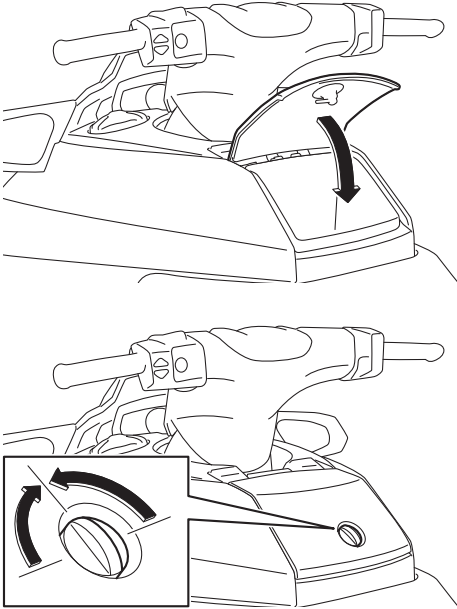

To drain water from the glove compartment:

(1) Remove the drain plug on the bottom of the glove compartment to drain the water.

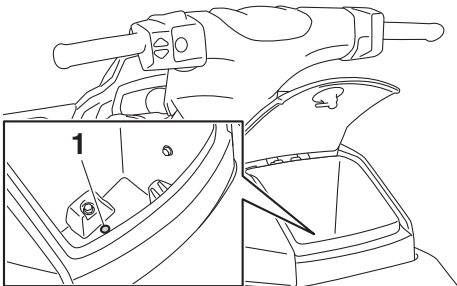

1 Drain plug

(2) Securely install the drain plug in its original position.

EJU42193

Stern storage compartment

The stern storage compartment is located in front of the boarding platform.

To open the stern storage compartment:

(1) Pull the rear of the stern storage compartment latch on both sides of the stern storage compartment lid outward, and then unhook the front of the latch from the hull.

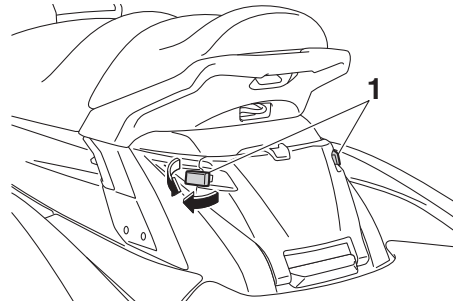

1 Stern storage compartment latch

(2) Open the lid.

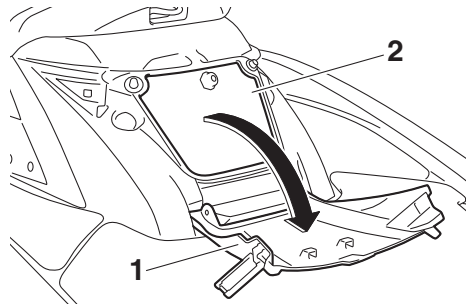

1 Stern storage compartment lid

2 Stern storage compartment

Stern storage compartment:

Capacity:

17.0 L (4.5 US gal, 3.7 Imp.gal)

Load limit:

1.5 kg (3 lb)

To close the stern storage compartment:

(1) Close the lid.

Equipment operation

- (2) Hook the front of the latch on both sides of the lid onto the hull, and then push the rear of the latch inward to securely lock it in place.

TIP:

The ski rope slot in the stern storage compartment lid can be used to store the rope in the stern storage compartment while the rope is attached to the cleat.

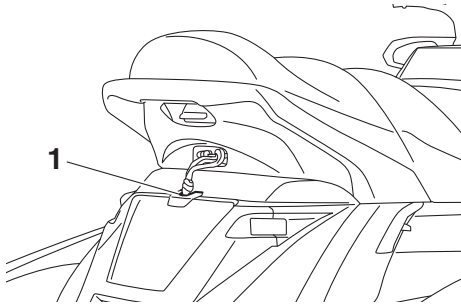

1 Ski rope slot

EJU42301

Beverage holders

This model is equipped with a built-in beverage holder and a removable beverage holder. Do not place any items in the beverage holders while riding. Otherwise, the items may fall out of the beverage holders.

Built-in beverage holder

The built-in beverage holder is located near the starboard (right) side of the multifunction information center.

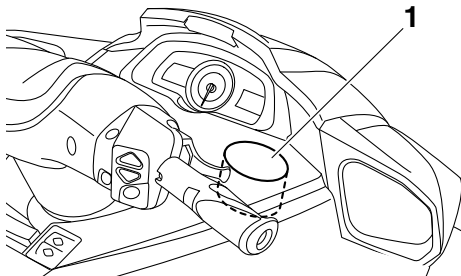

1 Built-in beverage holder

Removable beverage holder

The removable beverage holder is located in the glove compartment. (See page 53 for information on the glove compartment.)

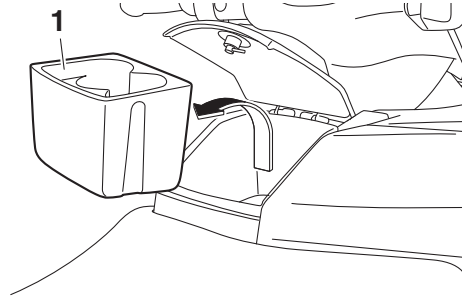

1 Removable beverage holder

EJU42311

Watertight storage compartments

This model is equipped with a built-in watertight storage compartment and a removable watertight storage compartment.

These compartments are watertight when their caps are closed securely.

Built-in watertight storage compartment

The built-in watertight storage compartment is located near the port (left) side of the multifunction information center.

Equipment operation

To open the built-in watertight storage compartment:

Loosen the cap and remove it.

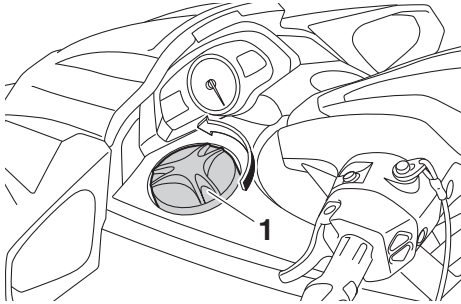

1 Cap

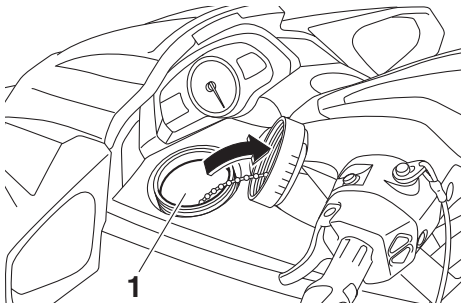

1 Built-in watertight storage compartment

Built-in watertight storage compartment:

Capacity:
2.5 L (0.7 US gal, 0.6 Imp.gal)
Load limit:
1.0 kg (2 lb)

To close the built-in watertight storage compartment:

Securely install the cap by tightening it until it stops.

Removable watertight storage compartment

The removable watertight storage compartment is located under the rear seat.

To open the removable watertight storage compartment:

- (1) Remove the rear seat. (See page 49 for seat removal and installation procedures.)
- (2) Loosen the cap and remove it.

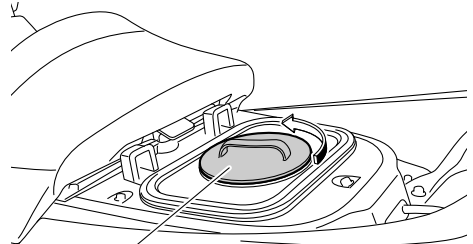

1 Cap

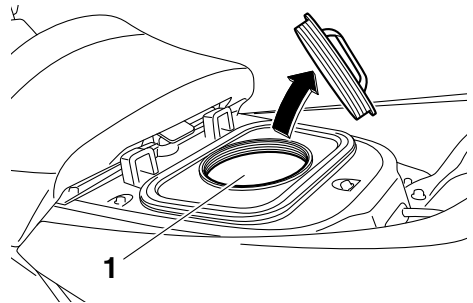

1 Removable watertight storage compartment

Removable watertight storage compartment:

Capacity:
9.0 L (2.4 US gal, 2.0 Imp.gal)
Load limit:
3.0 kg (7 lb)

To close the removable watertight storage compartment:

- (1) Securely install the cap by tightening it until it stops.
- (2) Securely install the rear seat in its original position.

EJU42391

Fire extinguisher holder and cover

The fire extinguisher holder and cover are located in the bow storage compartment.

To use the fire extinguisher holder and cover:

- (1) Pull the hood latch rearward, and then lift up the rear of the hood.

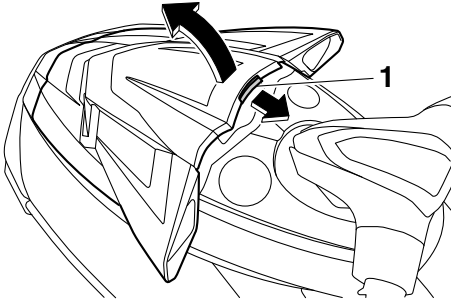

1 Hood latch

- (2) Unhook the band and remove the fire extinguisher cover.

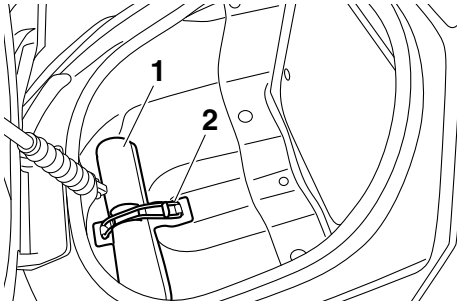

1 Fire extinguisher holder and cover

2 Band

- (3) Place the fire extinguisher in the holder, and then place the cover over the fire extinguisher.
- (4) Securely fasten the cover and the fire extinguisher with the band.
- (5) Push the rear of the hood down to securely lock it in place. Make sure that the

hood is securely closed before using the watercraft.

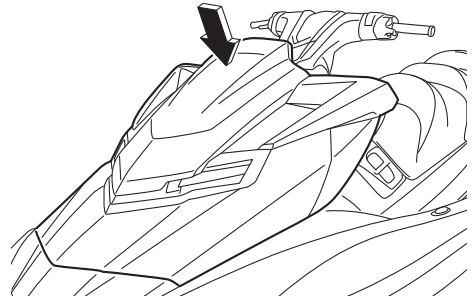

Operation and handling requirements

EJU31823

Fuel requirements

EJU42402

Fuel

EWJ00283

WARNING

- Gasoline and gasoline vapors are extremely flammable. To avoid fires and explosions and to reduce the risk of injury when refueling, follow these instructions.
- Gasoline is poisonous and can cause injury or death. Handle gasoline with care. Never siphon gasoline by mouth. If you should swallow some gasoline, inhale a lot of gasoline vapor, or get some gasoline in your eyes, see your doctor immediately. If gasoline spills on your skin, wash with soap and water. If gasoline spills on your clothing, change your clothes.

ECJ00322

NOTICE

- Do not use leaded gasoline. Leaded gasoline can seriously damage the engine.
- Avoid getting water and contaminants in the fuel tank. Contaminated fuel can cause poor performance and engine damage. Use only fresh gasoline that has been stored in clean containers.

Recommended fuel:

Regular unleaded gasoline with a minimum octane rating of

86

(Pump octane number) = $(R + M)/2$

90 (Research octane number)

Gasohol

There are two types of gasohol: gasohol containing ethanol and that containing methanol.

Gasohol containing ethanol can be used if ethanol content does not exceed 10% and the fuel meets the minimum octane ratings. E-85 is a fuel blend containing 85% ethanol and therefore must not be used in this watercraft. All ethanol blends containing more than 10% ethanol can cause fuel system damage or engine performance problems.

Yamaha does not recommend gasohol containing methanol because it can cause fuel system damage and engine performance problems.

To fill the fuel tank:

- (1) Before refueling, stop the engine. Do not stand or sit on the watercraft. Never refuel while smoking, or while in the vicinity of sparks, open flames, or other sources of ignition.
- (2) Place the watercraft in a well-ventilated area and in a horizontal position.
- (3) Remove the seats, and then check the fuel level. (See page 49 for seat removal and installation procedures.)
- (4) Pull the hood latch rearward, and then lift up the rear of the hood.

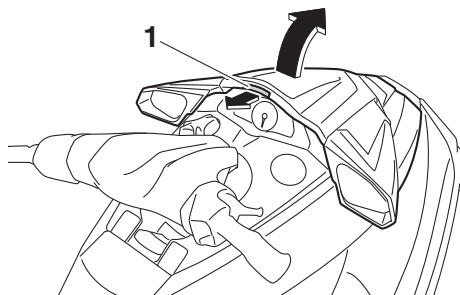

1 Hood latch

Operation and handling requirements

- (5) Loosen the fuel filler cap and remove it.

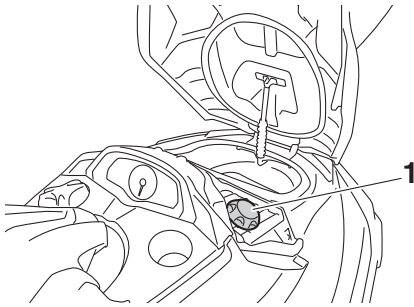

1 Fuel filler cap

- (6) Slowly add fuel to the fuel tank.

Fuel tank capacity:
70 L (18.5 US gal, 15.4 Imp.gal)

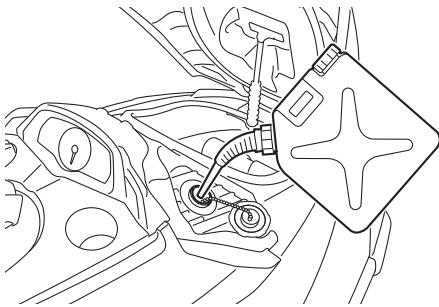

- (7) Stop filling when the fuel level reaches approximately 50 mm (2 in) from the top of the fuel tank. Do not overfill the fuel tank. Because fuel expands when it heats up, heat from the engine or the sun can cause fuel to spill out of the fuel tank.

Do not leave the watercraft with a full tank in direct sunlight.

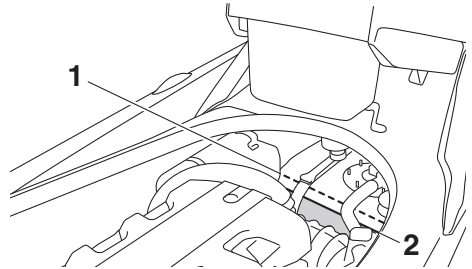

- 1 Top of the fuel tank
2 Approximately 50 mm (2 in) from top of the fuel tank

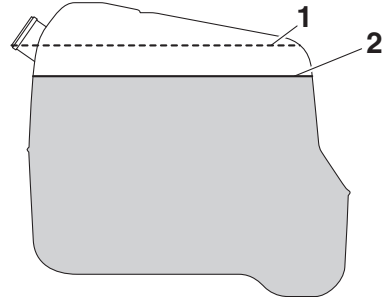

- 1 Top of the fuel tank
2 Approximately 50 mm (2 in) from top of the fuel tank
- (8) Wipe up any spilled fuel immediately with a dry cloth.
- (9) Securely install the fuel filler cap by tightening it until it clicks.
- (10) Push the rear of the hood down to securely lock it in place. Make sure that the

Operation and handling requirements

fuel filler cap and the hood are securely closed before using the watercraft.

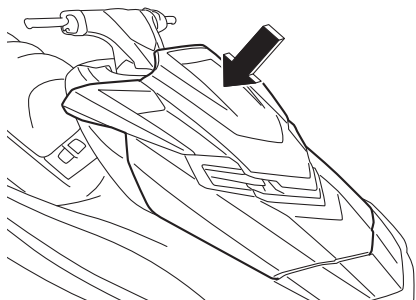

(11) Securely install the seats in their original positions.

EJU40291

Engine oil requirements

EJU41513

Engine oil

ECJ00282

NOTICE

Use only 4-stroke engine oil. Usage of 2-stroke engine oil could result in severe engine damage.

Recommended engine oil type:
SAE 10W-30, 10W-40, 20W-40,
20W-50
Recommended engine oil grade:
API SE,SF,SG,SH,SJ,SL

TIP:

When the engine is operated at high speeds, some engine oil may be consumed. Be sure to check the engine oil level.

Checking the engine oil level

EWJ00341

! WARNING

Engine oil is extremely hot immediately after the engine is turned off. Coming in contact with or getting any engine oil on your clothes could result in burns.

ECJ01002

NOTICE

Make sure that debris and water do not enter the oil filler hole. Debris and water in the engine oil can cause serious engine damage.

To check the engine oil level:

- (1) Place the watercraft in a precisely level position on land with the engine stopped. If the engine was running, allow the engine oil to settle by waiting 5 minutes or more before checking the oil level.
- (2) Remove the seats. (See page 49 for seat removal and installation procedures.)

Operation and handling requirements

- (3) Remove the dipstick and wipe it clean.

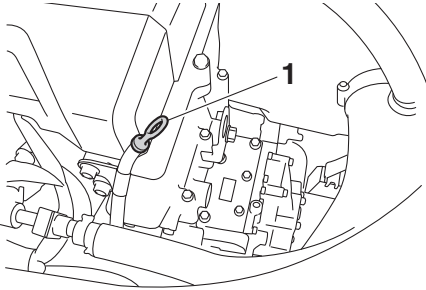

1 Dipstick

- (4) Insert the dipstick back into the dipstick tube completely. Remove the dipstick again and make sure that the engine oil level is between the minimum and maximum level marks.

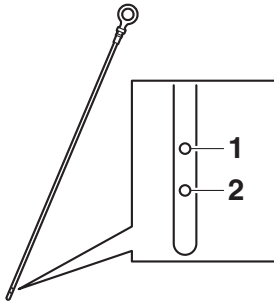

1 Maximum level mark

2 Minimum level mark

- (5) If the engine oil level is significantly above the maximum level mark, consult a Yamaha dealer. If the engine oil level is below the minimum level mark, add engine oil.

- (6) Loosen the engine oil filler cap and remove it.

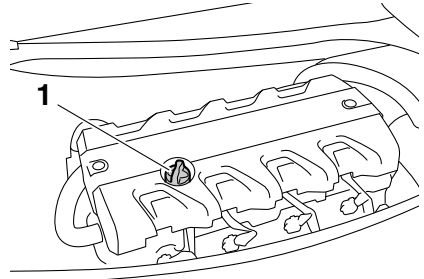

1 Engine oil filler cap

- (7) Slowly add engine oil.

TIP:

The difference between the minimum and maximum level marks on the dipstick is equal to approximately 1 L (1.06 US qt, 0.88 Imp.qt) of engine oil.

- (8) Wait approximately 5 minutes to allow the engine oil to settle, and then check the engine oil level again.
- (9) Repeat steps 3–8 until the engine oil is at the proper level.
- (10) Securely install the engine oil filler cap by tightening it until it stops.
- (11) Securely install the seats in their original positions.

Operation and handling requirements

EJU40022

Draining the bilge water

ECJ01302

NOTICE

Do not run the engine at full throttle when bilge water remains in the engine compartment. The bilge water can splash into the engine, which can result in severe damage.

EJU40036

Draining the bilge water on land

To drain the bilge water on land:

- (1) Loosen the stern drain plugs and remove them.

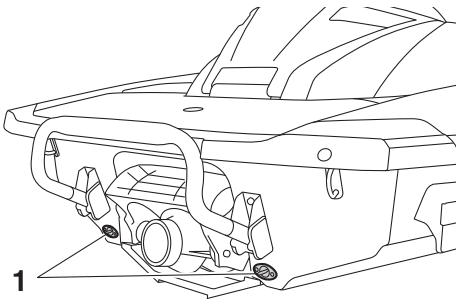

1

1 Stern drain plug

- (2) Raise the bow of the watercraft, such as by placing the watercraft on a slope, to drain the bilge water from the engine compartment.
- (3) After the bilge water has drained from the stern drain plug holes, wipe up any remaining moisture in the engine compartment with a dry cloth.
- (4) Securely install the stern drain plugs by tightening them until they stop. **NOTICE:** Before installing the stern drain plugs, clean the drain plug threads and the O-rings on the plugs to remove any foreign materials, such as dirt or sand. Otherwise, the stern drain plugs could be damaged, allowing water to enter the engine compartment. Check the

O-rings on the stern drain plugs and make sure that the plugs are tightened securely before launching the watercraft. Otherwise, water may flood the engine compartment and cause the watercraft to submerge. [ECJ00363]

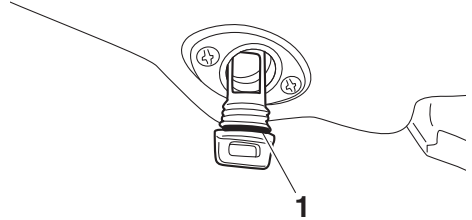

1 O-ring

EJU42171

Draining the bilge water on water

A small quantity of bilge water will remain in the engine compartment even after the bilge water is drained on water. To completely drain the bilge water, remove the watercraft from the water and drain the bilge water on land.

Jet vacuum bilge draining system

While the watercraft is operating, bilge water in the engine compartment is drawn in by the vacuum that is generated in the jet pump and discharged from the watercraft through the jet thrust nozzle.

To drain the bilge water on water:

Operate the watercraft as straight as possible and above planing speed for at least 2 minutes. **NOTICE:** Do not run the engine at full throttle for at least 1 minute after the engine has been restarted. Bilge water in the engine compartment can splash into the

Operation and handling requirements

engine, which can result in severe damage. [ECJ00554]

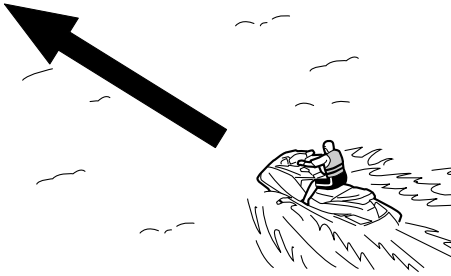

Electric bilge draining system

Bilge water in the engine compartment is drawn in by the operation of the electric bilge pump and discharged from the watercraft.

To drain the bilge water:

Start the engine to operate the electric bilge pump.

TIP:

The electric bilge pump continues to operate for a short time after the engine stops.

EJU42432

Transporting on a trailer

When transporting the watercraft on a trailer, secure the tie downs to the trailer through the bow eye and stern eyes. **NOTICE: Do not attach ropes or tie downs to any part of the watercraft other than the bow eye and stern eyes to secure the watercraft to the trailer. Otherwise, the watercraft may be damaged. Wrap the ropes or tie downs with towels or rags where they touch the body of the watercraft to avoid scratches or damage.** [ECJ02150]

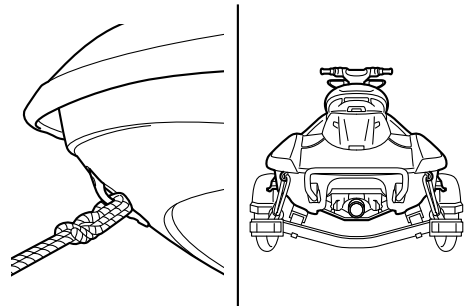

First-time operation

EJU36666

Engine break-in

ECJ00432

NOTICE

Failure to perform the engine break-in could result in reduced engine life or even severe engine damage.

The engine break-in is essential to allow the various components of the engine to wear and polish themselves to the correct operating clearances. This ensures proper performance and promotes longer component life.

To perform the engine break-in:

- (1) Check the engine oil level. (See page 60 for information on checking the engine oil level.)
- (2) Launch the watercraft and start the engine. (See page 77 for information on starting the engine.)
- (3) For the first 5 minutes, operate with the engine speed at 2000 r/min.
- (4) For the next 30 minutes, operate with the engine speed below 5000 r/min.
- (5) For the next 1 hour, operate with the engine speed below 6000 r/min.

After the engine break-in is complete, the watercraft can be operated normally.

Pre-operation checks

EJU31982

EWJ00412



Failure to inspect or maintain the watercraft properly increases the possibility of an accident or damage to the watercraft. Do not operate the watercraft if you find any problem. If a problem cannot be corrected by the procedures provided in this manual, have the watercraft inspected by a Yamaha dealer.

EJU41234

Pre-operation checklist

Before using this watercraft, be sure to perform the checks in the following checklist.

ITEM	ROUTINE	PAGE
PRE-LAUNCH CHECKS		
Engine compartment	Ventilate the engine compartment. Check inside the engine compartment for damage.	67
Fuel system	Check the fuel system for leakage. Check the fuel level in the fuel tank.	67
Water separator	Check the water separator for water.	67
Engine unit	Check the exterior of the engine unit for damage.	68
Engine oil level	Check the engine oil level.	68
Bilge water	Check the engine compartment for bilge water.	68
Battery	Check the battery connections and electrolyte level.	68
Steering system	Check the steering system for proper operation.	69
Adjustable tilt steering system	Check the adjustable tilt steering system for proper operation and check that the handlebars are securely locked in place.	70
RiDE lever	Check the RiDE lever for proper operation.	70
Throttle lever	Check the throttle lever for proper operation.	70
Remote control transmitter	Check the remote control transmitter for proper operation.	71
Engine shut-off cord (lanyard)	Check the engine shut-off cord (lanyard) for damage.	71
Switches	Check the start switch, engine stop switch, and engine shut-off switch for proper operation.	71
Storage compartments	Check the storage compartments for damage and water.	72
Fire extinguisher holder, cover, and band	Check the fire extinguisher holder, cover, and band for damage.	72
Fire extinguisher	Check the condition of the fire extinguisher.	72
Safety equipment	Check that safety equipment meeting the applicable regulations is on board.	72
Hull and deck	Check the hull and deck for damage.	72
Jet intake	Check the jet intake for damage and clogging.	72

Pre-operation checks

ITEM	ROUTINE	PAGE
Jet thrust nozzle and reverse gate	Check the jet thrust nozzle and reverse gate for damage.	72
Stern drain plugs	Check the stern drain plugs for damage and foreign material and check that they are securely installed.	72
Hood	Check that the hood is securely closed.	73
Front and rear seats	Check that the seats are securely installed.	49
POST-LAUNCH CHECKS		
Cooling water pilot outlet	Check that water is discharged from the cooling water pilot outlet while the engine is running.	73
Multifunction information center	Check the multifunction information center for proper operation.	73
Shift system	Check the shift system for proper operation.	74
Trim indicator	Check the trim indicator for proper operation.	75
Engine idling speed	Check the engine idling speed.	75

TIP:

To ensure safety and reliability, pre-operation checks should be made each time the watercraft is used.

Pre-operation checks

EJU32282

Pre-operation check points

EJU42383

Pre-launch checks

Perform the pre-launch checks in the pre-operation checklist while the watercraft is on land.

To perform the pre-launch checks:

- (1) Remove the seats and removable watertight storage compartment. (See page 49 for seat removal and installation procedures and page 55 for information on the removable watertight storage compartment.)
- (2) Perform the checks and make sure that there are no malfunctioning items or other problems.
- (3) After completing these checks, securely install the removable watertight storage compartment and seats in their original positions.

EJU32334

Engine compartment check

EWJ00462



Failure to ventilate the engine compartment could result in a fire or explosion. Do not start the engine if there is a fuel leak.

Ventilate the engine compartment. Leave the engine compartment open for a few minutes to allow any fuel vapors to escape.

Make sure that there is no damage inside the engine compartment.

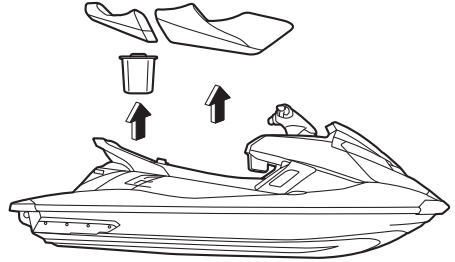

EJU34215

Fuel system checks

EWJ00382



Leaking fuel can result in fire or explosion.

- Check for fuel leakage regularly.
- If any fuel leakage is found, the fuel system must be repaired by a qualified mechanic. Improper repairs can make the watercraft unsafe to operate.

Make sure that there is no damage, leakage, or other problem in the fuel system.

Check:

- Fuel filler cap and seal for damage
- Fuel tank for damage and leakage
- Fuel hoses and joints for damage and leakage
- Fuel tank breather hose for damage and leakage

EJU36875

Fuel level check

Check the fuel level in the fuel tank.

Add fuel if necessary. (See page 58 for information on filling the fuel tank.)

EJU32424

Water separator check

Make sure that no water has collected in the water separator. If water has collected in the

Pre-operation checks

water separator, drain it. (See page 31 for information on draining the water separator.)

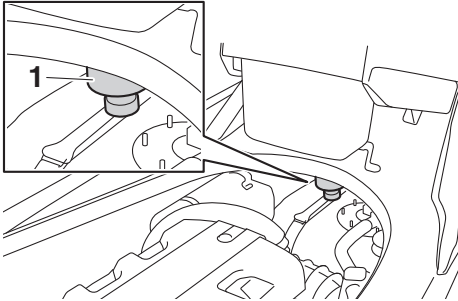

1 Water separator

EJU40182

Engine unit check

Check the exterior of the engine unit for damage or other problem.

EJU36886

Engine oil level check

Make sure that the engine oil level is between the minimum and maximum level marks on

the dipstick. (See page 60 for information on checking the engine oil level.)

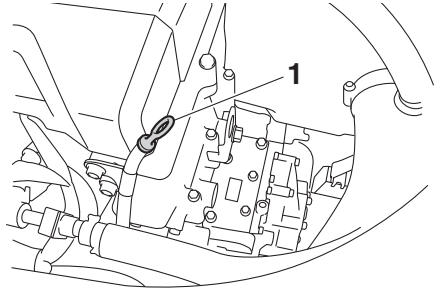

1 Dipstick

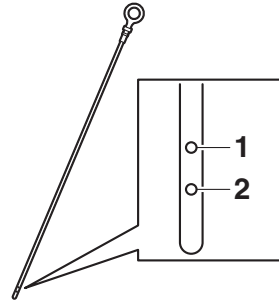

1 Maximum level mark

2 Minimum level mark

EJU32456

Bilge water check

Make sure that no bilge water has collected in the engine compartment. If bilge water has collected in the engine compartment, drain it. (See page 62 for information on draining the bilge water.)

EJU32485

Battery checks

Make sure that the battery terminals and breather hose are not damaged and that the battery leads and breather hose are connected properly. **WARNING! Fire or explosion could result if the breather hose is dam-**

Pre-operation checks

aged, obstructed, or not connected properly. [EWJ00452]

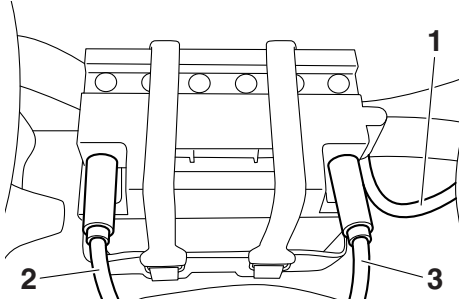

- 1 Breather hose
- 2 Negative (-) battery terminal: Black lead
- 3 Positive (+) battery terminal: Red lead

Make sure that the electrolyte level is between the minimum and maximum level marks. **WARNING! Never operate the watercraft if the battery does not have sufficient power to start the engine or if it shows any other signs of decreased power. Loss of battery power may leave you stranded.** [EWJ01241]

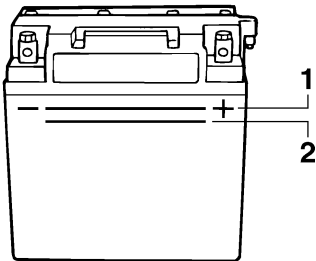

- 1 Maximum level mark
- 2 Minimum level mark

Make sure that the battery is securely held in place.

EJU32614

Steering system checks

Turn the handlebars to the right and left several times to make sure that operation is smooth and unrestricted throughout the

whole range, and that the free play is not excessive.

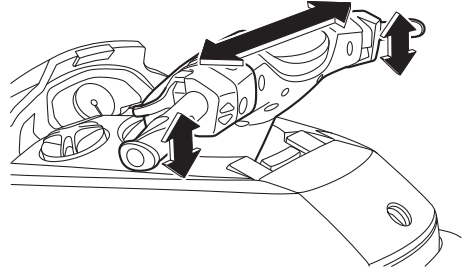

Turn the handlebars as far as possible to the right and left to make sure that the jet thrust nozzle moves as the handlebars are turned, and that there is no difference between the

Pre-operation checks

right and left fully turned positions of the jet thrust nozzle.

locked in place. (See page 30 for adjustable tilt steering system operation procedures.)

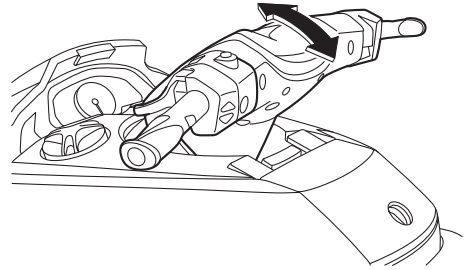
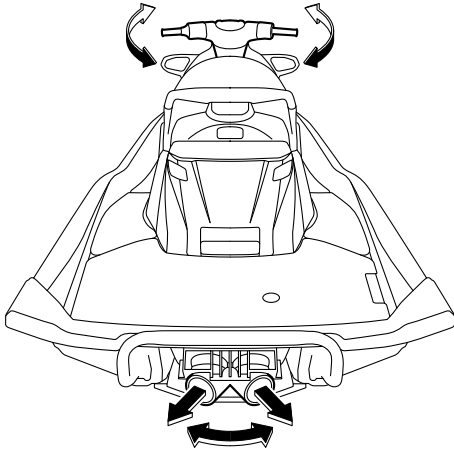

EJU43212

RiDE lever checks

Operate the RiDE lever several times to make sure that operation is smooth throughout the whole range. Also, make sure that the RiDE lever returns automatically to its fully closed position when released.

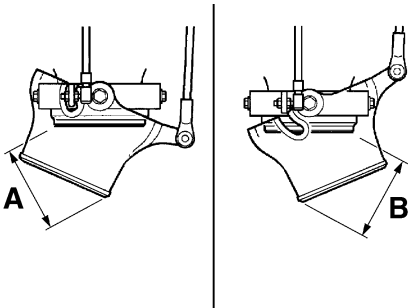

Difference between fully turned positions of jet thrust nozzle (distances A and B):

Maximum 5 mm (0.20 in)

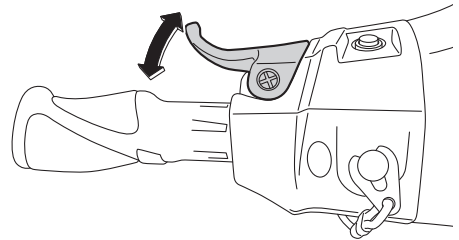

EJU42181

Throttle lever checks

Operate the throttle lever several times to make sure that operation is smooth throughout the whole range. Also, make sure that the

EJU40363

Adjustable tilt steering system checks

Operate the adjustable tilt steering system several times to make sure that operation is smooth throughout the whole range. Also, make sure that the handlebars are securely

Pre-operation checks

throttle lever returns automatically to its fully closed (idle) position when released.

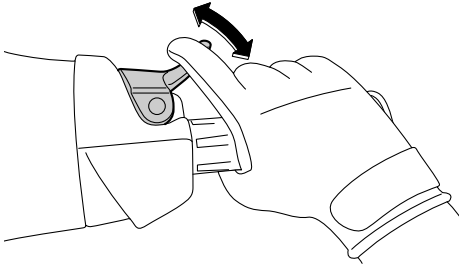

EJU40113

Remote control transmitter check

Make sure that the remote control transmitter operates properly. (See page 27 for Yamaha Security System setting procedures and page 36 for Low RPM Mode activation procedures.)

EJU32664

Engine shut-off cord (lanyard) check

Make sure that the engine shut-off cord (lanyard) is not damaged. If the cord is damaged, replace it. **WARNING! Never try to repair the engine shut-off cord (lanyard) or tie it together. The engine shut-off cord (lanyard) may not pull free when the operator falls off, allowing the watercraft to continue to run and cause an accident.** [EJWJ01221]

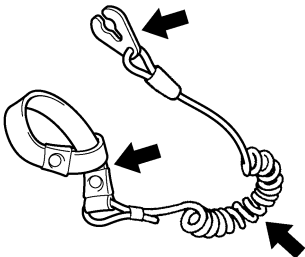

EJU32676

Switch checks

ECJ01311

NOTICE

Do not run the engine over 4000 r/min on land. Also, do not run the engine for more than 15 seconds without supplying water, otherwise the engine could overheat.

Check the start switch, the engine stop switch, and the engine shut-off switch for proper operation. (See pages 28 to 28 for information on operating each switch.)

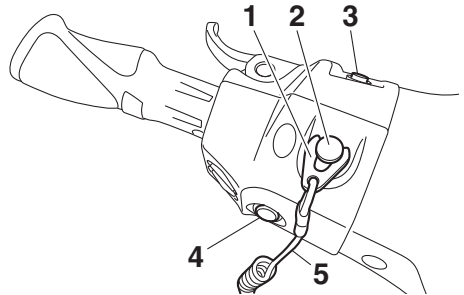

- 1 Clip
- 2 Engine shut-off switch
- 3 Start switch
- 4 Engine stop switch
- 5 Engine shut-off cord (lanyard)

To check the operation of the switches:

- (1) If the lock mode is selected for the Yamaha Security System setting, select the unlock mode. (See page 27 for Yamaha Security System setting procedures.)
- (2) Push the start switch to make sure that the engine starts.
- (3) As soon as the engine starts running, push the engine stop switch to make sure that the engine stops immediately.
- (4) Restart the engine, and then pull the engine shut-off cord (lanyard) to remove the clip from the engine shut-off switch

Pre-operation checks

to make sure that the engine stops immediately.

EJU40102

Storage compartment checks

Make sure that the storage compartments are not damaged and that water has not collected in the compartments. (See page 52 for information on the storage compartments.)

EJU41082

Fire extinguisher holder, cover, and band checks

Make sure that the fire extinguisher holder, cover, and band are not damaged and that the cover is securely held in place using the band. (See page 57 for information on the fire extinguisher holder, cover, and band.)

EJU32544

Fire extinguisher check

Check that there is a full fire extinguisher on board.

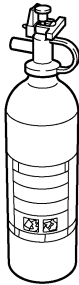

To check the fire extinguisher, see the instructions supplied by the fire extinguisher manufacturer. Always keep the fire extinguisher secured in the holder with its cover in place.

Always carry a fire extinguisher on board. A fire extinguisher is not standard equipment with this watercraft. If you do not have one, contact a Yamaha dealer or a fire extinguisher dealer to obtain one meeting the proper specifications.

EJU40122

Safety equipment check

Check that safety equipment meeting the applicable regulations is on board.

EJU32353

Hull and deck check

Check the hull and deck for damage or other problem.

EJU32657

Jet intake checks

Make sure that the jet intake is not damaged or clogged with weeds or debris. If the jet intake is clogged, clean it. (See page 102 for information on the jet intake.)

EJU43220

Jet thrust nozzle and reverse gate check

Check the jet thrust nozzle and reverse gate for damage or other problem.

EJU32477

Stern drain plug checks

Loosen the stern drain plugs and remove them, and then make sure that the plugs and O-rings on the plugs are not damaged and that there is no foreign material on the threads or O-rings on the plugs. **NOTICE:** Before installing the stern drain plugs, clean the drain plug threads and the O-rings on the plugs to remove any foreign materials, such as dirt or sand. Otherwise, the stern drain plugs could be damaged, allowing water to enter the engine compartment. Check the O-rings on the stern drain plugs and make sure that the plugs are tightened securely before launching the watercraft. Otherwise, water may flood the engine compartment and cause the watercraft to submerge. [ECJ00363]

Pre-operation checks

Securely install the stern drain plugs by tightening them until they stop.

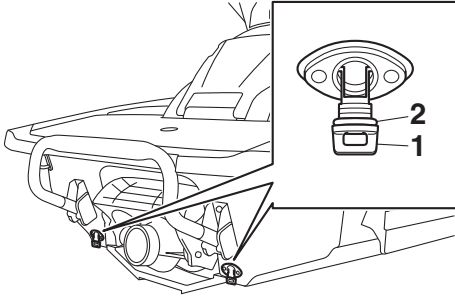

- 1 Stern drain plug
- 2 O-ring

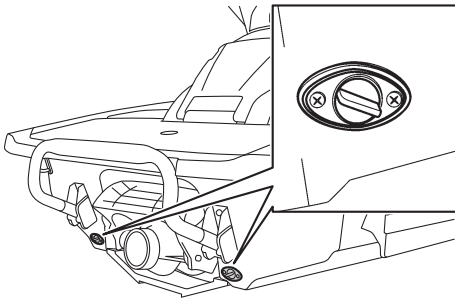

EJU41441

Hood check

Push down on the rear of the hood and make sure that it is securely closed.

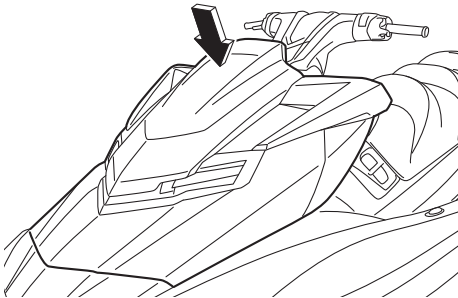

EJU40146

Post-launch checks

Perform the post-launch checks in the pre-operation checklist while the watercraft is in the water and the engine is running.

To perform the post-launch checks:

- (1) Launch the watercraft. (See page 77 for information on launching the watercraft.)
- (2) Perform the checks and make sure that there are no malfunctioning items or other problems.

EJU40553

Cooling water pilot outlet check

Make sure that water is discharged from the cooling water pilot outlet while the engine is running. (See page 31 for information on the cooling water pilot outlet.)

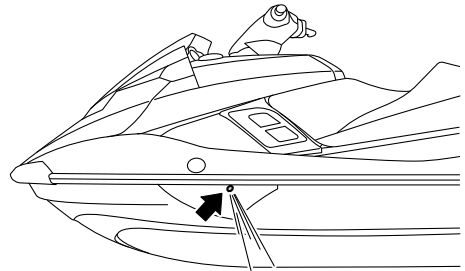

EJU32715

Multifunction information center check

Make sure that the multifunction information center operates properly. (See page 40 for in-

Pre-operation checks

formation on proper operation of the multi-function information center.)

safe distance away from people, objects, and other watercraft. [EWJ01860]

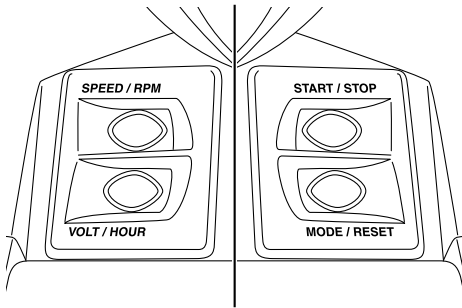
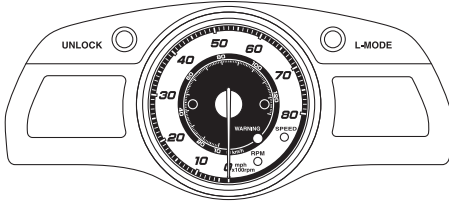

EJU43391

Shift system check

Operate the throttle lever and RiDE lever, and check that the watercraft moves or does not move according to the displayed shift indicator. (See page 32 for shift system operation procedures.) **WARNING! To avoid collisions, operate at safe speeds and keep a**

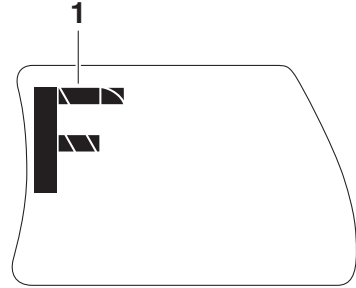

1 "F" (Forward position)

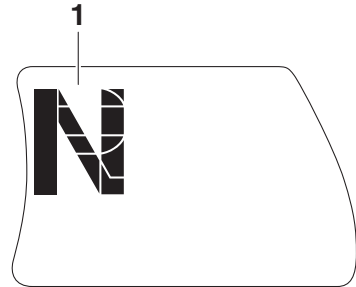

1 "N" (Neutral position)

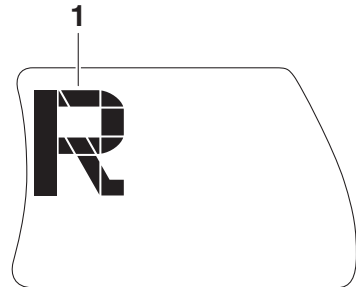

1 "R" (Reverse position)

EJU43400

Trim indicator check

Operate the electric trim switches and check that the trim indicator shows the correct trim angle of the jet thrust nozzle. (See page 34 for electric trim system operation procedures.)

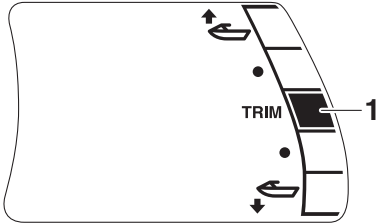

1 Trim indicator

EJU40172

Engine idling speed check

Start the engine and warm it up. Use the tachometer in the multifunction information center to make sure that the engine idling speed is not significantly above or below the specified range.

Engine idling speed: 1300 \pm 100 r/min
--

Operation

EJU32903

Operating your watercraft

EWJ00511



Before operating your watercraft, become familiar with all of the controls. Consult a Yamaha dealer about any control or function that you do not fully understand. Failure to understand how the controls work could cause an accident or prevent you from avoiding an accident.

EJU32965

Getting to know your watercraft

Operating your watercraft requires skills acquired through practice over a period of time. Take the time to learn the basic techniques well before attempting more difficult maneuvers.

Operating your new watercraft can be a very enjoyable activity, providing you with hours of pleasure. However, it is essential to familiarize yourself with the operation of the watercraft to achieve the skill level necessary to enjoy riding safely.

Before operating this watercraft, read this owner's/operator's manual, the Riding Practice Guide, the Riding Instruction card, and all labels on the watercraft. Pay particular attention to the safety information beginning on page 11. These materials should give you an understanding of the watercraft and its operation.

Remember: This watercraft is designed to carry the operator and up to 2 passengers. Never exceed the maximum load limit or allow more than 3 persons (or 2 persons if a wakeboarder or water-skier is being pulled) to ride the watercraft at any time.

Maximum load:
240 kg (530 lb)
Load is the total weight of cargo, operator, and passengers.

EJU33006

Learning to operate your watercraft

Before operating the watercraft, always perform the pre-operation checks listed on page 65. The short time spent checking the watercraft will reward you with added safety and reliability.

Check local laws before operating your watercraft.

Operate defensively at safe speeds and keep a safe distance away from people, objects, and other watercraft. Select a wide area to learn in, where there is good visibility and light boat traffic.

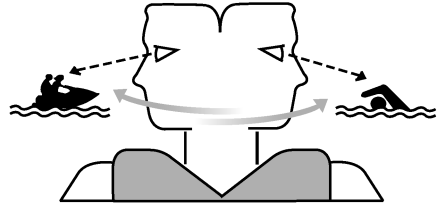

Use the buddy system—operate with someone nearby. Scan constantly for people, objects, and other watercraft. Be alert for conditions that limit your visibility or block your vision of others.

You should grip the handlebars firmly and keep both feet on the floor of the footwell. Do not attempt to ride with passengers until your operating skills are fully developed.

EJU40212

Riding position

Operator riding position

The operator should grip the handlebars firmly with both hands and sit astride the seat with both feet on the floor of the footwell.



Passenger riding position

The passenger(s) should hold on firmly, either to the person in front of them or to the hand-grip provided, and sit astride the seat with their feet on the floor of the footwell. Never allow a passenger to ride in front of the operator. (See page 18 for information on the riding position when pulling a wakeboarder or water-skier.)



EJU32803

Launching the watercraft

When launching the watercraft, make sure that there are no obstacles around you.

If the watercraft is launched from a trailer, someone should make sure that waves do not push the watercraft into the trailer.

EJU36346

Starting the engine on water

EWJ01531

WARNING

Do not apply throttle when anyone is at the rear of the watercraft. Turn the engine off or keep it at idle. Water and debris exiting the jet thrust nozzle can cause severe injury.

To start the engine:

- (1) If the lock mode is selected for the Yamaha Security System setting, select the unlock mode. (See page 27 for Yamaha Security System setting procedures.)
- (2) Move the watercraft to an area that is free from weeds and debris, and has a water depth of at least 60 cm (2 ft) from the bottom of the watercraft. **NOTICE: Never run the engine in water that is less than 60 cm (2 ft) deep from the bottom of the watercraft, otherwise pebbles or sand could be sucked into the jet intake, causing impeller damage and engine overheating.** [ECJ00473]

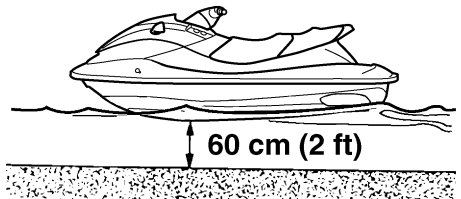

- (3) Attach the engine shut-off cord (lanyard) to your left wrist, and then attach the clip to the engine shut-off switch. (See page 28 for information on operating the engine shut-off switch.) **WARNING! Check that the engine shut-off cord (lanyard)**

Operation

is attached correctly. If the engine shut-off cord (lanyard) is not attached correctly, it may not pull free when the operator falls off, allowing the watercraft to continue to run and cause an accident. [EWJ00582]

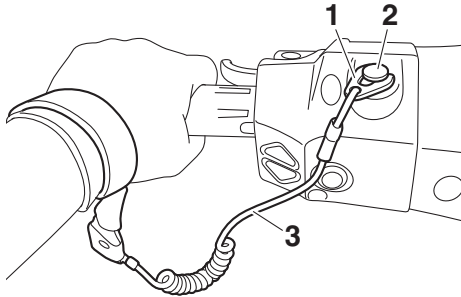

- 1 Clip
- 2 Engine shut-off switch
- 3 Engine shut-off cord (lanyard)

- (4) With the throttle lever released, push the start switch (green button) to start the engine. (See page 28 for information on operating the start switch.)

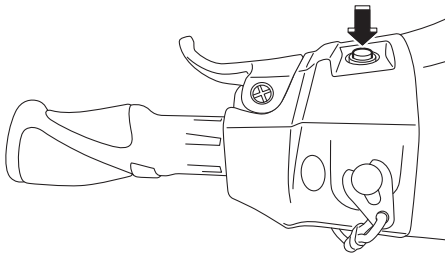

EJU32863

Stopping the engine

Release the throttle lever, and then push the engine stop switch (red button) to stop the engine. **WARNING! You need throttle to steer. Shutting the engine off can cause you to hit an obstacle you are attempting**

to avoid. A collision could result in severe injury or death. [EWJ00602]

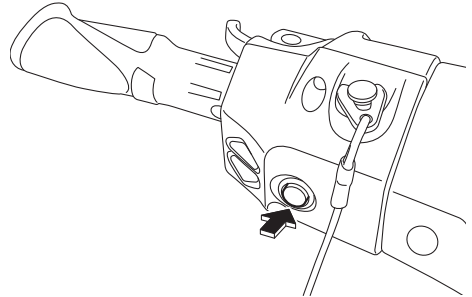

EJU32873

Leaving the watercraft

If leaving the watercraft, remove the clip from the engine shut-off switch to prevent accidental starting or unauthorized operation by children or others.

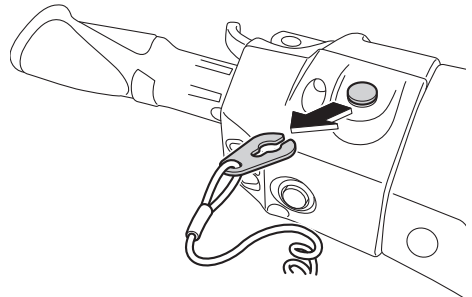

EJU43410

Operating the watercraft

When the throttle lever is squeezed, the “F” (forward) shift indicator will be displayed in the multifunction display and the watercraft will move forward. While the “F” (forward) shift indicator is displayed, the watercraft will move forward at trolling speed even if the throttle lever is in the fully closed (idle) posi-

tion. (See page 32 for shift system operation procedures.)

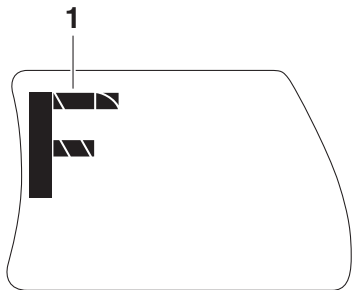

1 "F" (Forward position)



EJU43421

Turning the watercraft

EWJ01781

WARNING

- Do not release the throttle lever when trying to steer away from objects—you need throttle to steer. A collision could result in severe injury or death.
- When operating at higher speeds, make gradual turns or slow down before turning. Sharp high-speed turns may cause the watercraft to slide sideways or spin, throwing the operator and passenger(s) overboard, which could cause an injury.
- Take early action to avoid collisions. The RiDE system is not a braking device for avoiding dangerous situations.

Steering control depends on the combination of handlebar position and the amount of throttle.

Water sucked in through the intake grate is pressurized by the impeller in the jet pump. As the pressurized water is expelled from the pump through the jet thrust nozzle, it creates thrust to move and steer the watercraft. The higher the engine speed, the more thrust produced.

The amount of jet thrust, in addition to the position of the handlebars, determines how sharply you turn.

- A. More throttle produces higher thrust, so the watercraft will turn more sharply.

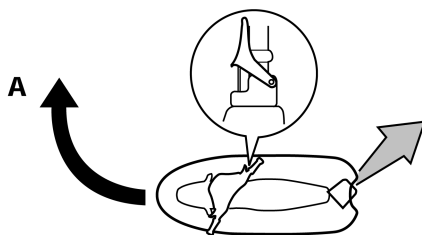

- B. Less throttle produces lower thrust, so the watercraft will turn more gradually.

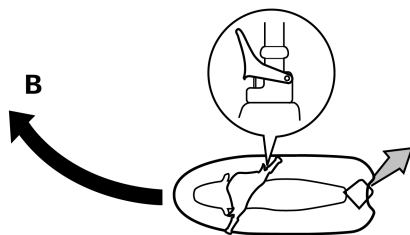

- C. Releasing the throttle lever completely produces only minimum thrust. If you are traveling at speeds above trolling, you will have rapidly decreasing ability to

Operation

steer without throttle. You may still have some turning ability immediately after releasing the throttle lever, but once the engine slows down, the watercraft will no longer respond to handlebar input until you apply throttle again or you reach trolling speed.

At trolling speed, the watercraft can be turned gradually by handlebar position alone using just the amount of thrust available at idle.

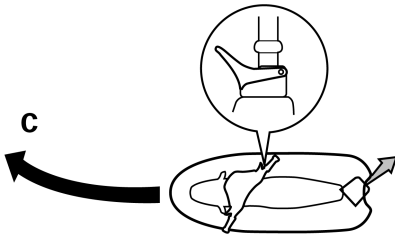

- D. If the engine is stopped while riding, there is no thrust. The watercraft will go straight even though the handlebars are turned.

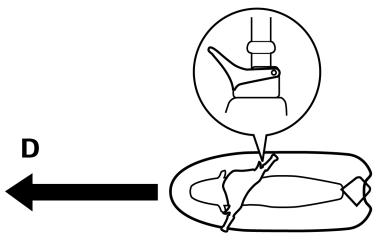

You need throttle to steer.

- E. If the RiDE lever is squeezed and the handlebars are turned when the watercraft is cruising at planing speed, the wa-

tercraft will turn gradually while slowing down.

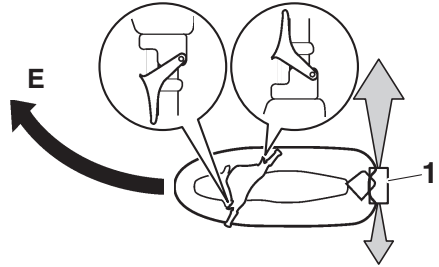

1 Reverse gate

This model is equipped with the Yamaha Engine Management System (YEMS) that includes an off-throttle steering (OTS) system. It will activate at planing speeds should you attempt to steer the watercraft after releasing the throttle lever (see condition C above).

The OTS system assists in turning by continuing to supply some thrust while the watercraft is decelerating, but you can turn more sharply if you apply throttle while turning the handlebars. The OTS system does not function below planing speeds or when the engine is off. Once the engine slows down, the watercraft will no longer turn in response to handlebar input until you apply throttle again or you reach trolling speed.

EJU43251

Stopping the watercraft

The watercraft is not equipped with a separate braking system. The watercraft slows down by water resistance or, when operating in reverse, by the water jet. The watercraft slows down as soon as the throttle lever is released, but will coast for a distance before fully stopping. If you are not sure you can stop in time before hitting an obstacle, apply throttle and turn in another direction.

From full speed, the watercraft comes to a complete stop due to water resistance in ap-

proximately 110 m (360 ft) after the throttle lever is released or the engine is stopped, although this distance will vary depending on many factors, including gross weight, water surface conditions, and wind direction.

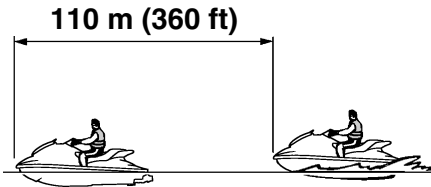

If the RiDE lever is squeezed to slow down, the stopping distance is approximately 30% shorter than when the RiDE lever is not used. However, this distance will vary depending on many factors, including gross weight, water surface conditions, and wind direction.

EWJ01791

WARNING

- Allow adequate stopping distance.
- Take early action to avoid collisions. Remember, watercraft and other boats do not have brakes.
- Operate defensively at safe speeds and keep a safe distance away from people, objects, and other watercraft to give you time to stop.
- Do not shut the engine off when slowing down in case you need engine power to steer away from a boat or other obstacle that comes into your path.
- To avoid rear-end collisions while operating the watercraft, check behind you before using the RiDE lever to slow down or stop the watercraft.

EJU43441

Operating the watercraft in reverse or neutral

Operating in reverse

When the RiDE lever is squeezed, the “R” (reverse) shift indicator will be displayed in the multifunction display and the watercraft will move in reverse. (See page 32 for shift system operation procedures.)

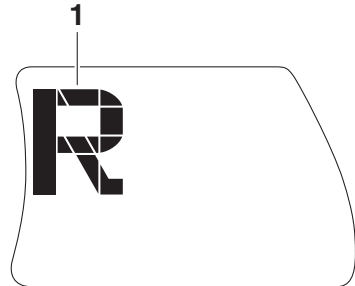

1 “R” (Reverse position)



Make sure that there are no obstacles or people behind you before shifting into reverse.

TIP:

This model is equipped with a function which limits the engine speed in reverse.

Operating in neutral

When the RiDE lever is squeezed lightly and released, the “N” (neutral) shift indicator will be displayed in the multifunction display and the watercraft will stop in its current location.

Operation

(See page 32 for shift system operation procedures.)

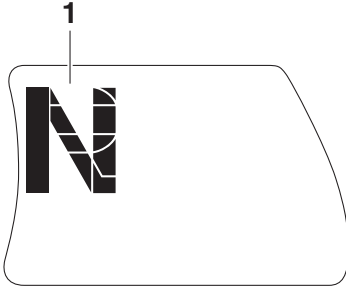

1 "N" (Neutral position)



NOTICE: Never run the engine in water that is less than 60 cm (2 ft) deep from the bottom of the watercraft, otherwise pebbles or sand could be sucked into the jet intake, causing impeller damage and engine overheating. [ECJ00473]

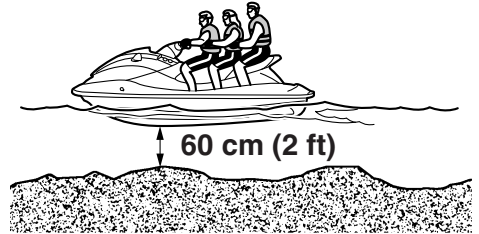

EJU42461

Boarding alone

- (1) From the rear of the watercraft, lower the reboarding step with one hand and hold it in place.

TIP:

This model is equipped with a function which limits the engine speed in neutral.

EJU42451

Boarding the watercraft

EWJ01112

WARNING

Be sure the operator and any passengers have practiced boarding from the water while still close to shore before riding. A person who has made many unsuccessful attempts to get back on the watercraft may become fatigued and suffer from exposure, increasing the risk of injury and drowning.

Board the watercraft in water free from weeds and debris and at least 60 cm (2 ft) deep from the bottom of the watercraft.

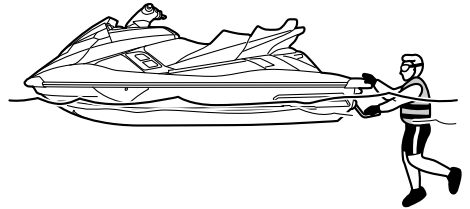

- (2) Put one foot on the step, and then grasp the reboarding grip with your other hand.

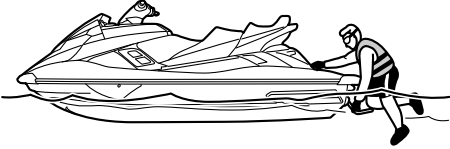

- (3) Pull yourself up onto the boarding platform and grasp the handgrip, and then move to the seat and sit astride.

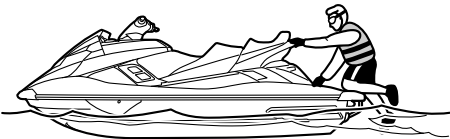

- (4) Attach the engine shut-off cord (lanyard) to your left wrist, and then attach the clip to the engine shut-off switch.
- (5) Grip the handlebars with both hands and place both feet on the floor of the footwell.



- (6) Look in all directions, start the engine, and then start off slowly.

EJU43260

Boarding with passenger(s)

EWJ01800

! WARNING

- Severe internal injuries can occur if water is forced into body cavities as a result of being near the jet thrust nozzle. Do not start the engine until the passengers are seated with their feet on the floor of the footwell and are securely holding on to the person in front of them or to the handgrip provided.
- Before boarding the watercraft, make sure that the engine is stopped. If the engine is running, the reverse gate may move down and a person boarding could be pinched.

The heavier the total weight of the operator and passenger(s), the more difficult it will be to balance the watercraft. Do not operate the watercraft when the total weight exceeds 240 kg (530 lb) including any cargo.

To board with passenger(s):

- (1) Board as noted in the previous section "Boarding alone".

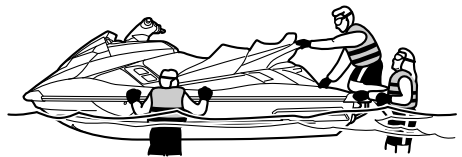

- (2) Grip the handlebars with both hands and place both feet on the floor of the footwell.

Operation

- (3) Have the first passenger move to the rear of the watercraft.

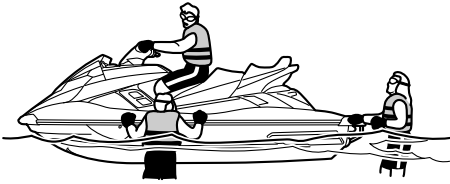

- (4) Have the first passenger board using the same procedure as the operator, place their feet on the floor of the footwell, and securely hold on to the operator.

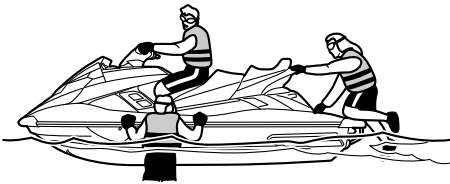

- (5) Have the second passenger follow the same procedure. When the second passenger is boarding, try to balance the watercraft together with the first passenger.



- (6) Make sure that the passenger(s) have their feet on the floor of the footwell and are securely holding on to the person in front of them or to the handgrip provided.

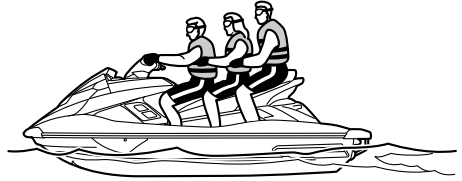

- (7) Attach the engine shut-off cord (lanyard) to your left wrist, and then attach the clip to the engine shut-off switch.
- (8) Look in all directions, start the engine, and then start off slowly.

EJU33083

Starting off

EWJ00712

WARNING

To avoid collisions:

- Scan constantly for people, objects, and other watercraft. Be alert for conditions that limit your visibility or block your vision of others.
- Operate defensively at safe speeds and keep a safe distance away from people, objects, and other watercraft.
- Do not follow directly behind watercraft or other boats. Do not go near others to spray or splash them with water. Avoid sharp turns or other maneuvers that make it hard for others to avoid you or understand where you are going. Avoid areas with submerged objects or shallow water.
- Take early action to avoid collisions. Remember, watercraft and other boats do not have brakes. Do not release the

throttle lever when trying to steer away from objects—you need throttle to steer.

ECJ01341

NOTICE

Never run the engine in water that is less than 60 cm (2 ft) deep from the bottom of the watercraft, otherwise pebbles or sand could be sucked into the jet intake, causing impeller damage and engine overheating.

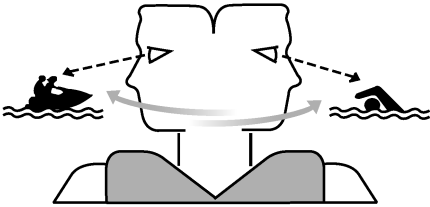

EJU43271

Starting off from a trailer

- (1) Launch the watercraft.
- (2) Attach the engine shut-off cord (lanyard) to your left wrist, and then attach the clip to the engine shut-off switch.
- (3) Look in all directions, and then start the engine.
- (4) Squeeze the RiDE lever and move the watercraft back slowly. (See page 32 for RiDE lever operation procedures.)

EJU33114

Boarding and starting off from a dock

- (1) Board the watercraft from the side.
- (2) Attach the engine shut-off cord (lanyard) to your left wrist, and then attach the clip to the engine shut-off switch.
- (3) Push the watercraft away from the dock, grip the handlebars with both hands, and

place both feet on the floor of the footwell.

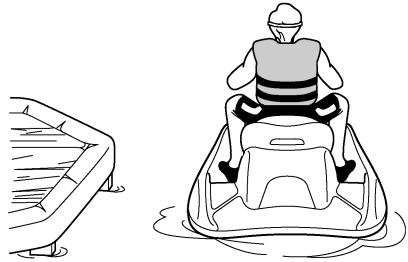

- (4) Look in all directions, start the engine, and then start off slowly.

EJU33236

Capsized watercraft

EWJ00672

WARNING

Improper uprighting can cause injury.

- Be sure to shut the engine off by pulling on the engine shut-off cord (lanyard) to remove the clip from the engine shut-off switch.
- Do not put your hands in the intake grate.

If the watercraft capsizes, turn it over immediately.

To upright the watercraft:

- (1) Remove the clip from the engine shut-off switch.
- (2) Swim to the rear of the watercraft. Turn the watercraft over clockwise by pulling on the ride plate with your left hand while pushing down on the gunwale with your right hand or foot.

If the port (left) side of the capsized watercraft is tilting up, push down on the gunwale so that the port (left) side is down before turning the watercraft clockwise. **NOTICE: Do not turn the watercraft over counterclockwise,**

Operation

otherwise water can enter the engine, which can result in severe damage.

[ECJ00542]

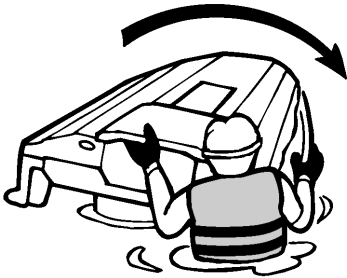

- (3) Start the engine and operate the watercraft at planing speed to drain the bilge water from the engine compartment. (See page 62 for information on draining the bilge water. If the engine does not start, see “Towing the watercraft” on page 106 or “Submerged watercraft” on page 106.) **NOTICE: Do not run the engine at full throttle for at least 1 minute after the engine has been restarted. Bilge water in the engine compartment can splash into the engine, which can result in severe damage.**

[ECJ00554]

EJU43282

Beaching and docking the watercraft

To beach the watercraft:

- (1) Make sure that there are no boats, swimmers, or obstacles near the beach.

- (2) Release the throttle lever to reduce speed about 110 m (360 ft) before you reach the intended beaching area.
- (3) Slowly approach the beach using the throttle lever and RiDE lever to control the watercraft speed. **NOTICE: Never run the engine in water that is less than 60 cm (2 ft) deep from the bottom of the watercraft, otherwise pebbles or sand could be sucked into the jet intake, causing impeller damage and engine overheating.** [ECJ00473]
- (4) After reaching land, stop the engine, and then get off the watercraft and pull it up on the beach.

To dock the watercraft:

- (1) Make sure that there are no boats, swimmers, or obstacles near the dock.
- (2) Release the throttle lever to reduce speed about 110 m (360 ft) away from the dock.
- (3) Slowly approach the dock using the throttle lever and RiDE lever to control the watercraft speed.
- (4) After coming alongside the dock, stop the engine, and then get off the watercraft.

EJU37194

Operating in weeded areas

Always avoid using your watercraft in areas where weed growth is thick. If operating in weeded areas is unavoidable, alternately squeeze the throttle lever and relax your grip on the throttle lever to vary the engine speed. Weeds tend to become clogged more when operating at a steady speed and at trolling speed. If weeds may have clogged the intake area, clean the jet intake. (See page 102 for information on the jet intake.)

EJU40242

After removing the watercraft from the water

ECJ01311

NOTICE

Do not run the engine over 4000 r/min on land. Also, do not run the engine for more than 15 seconds without supplying water, otherwise the engine could overheat.

After operating and removing the watercraft from the water, promptly discharge the remaining water from the cooling water passages.

To discharge water from the cooling water passages:

- (1) Make sure that the area around the watercraft is clear, and then start the engine.
- (2) Discharge the remaining water out of the cooling water passages by alternately squeezing and releasing the throttle lever quickly for 10 to 15 seconds.
- (3) Stop the engine.

Care and storage

EJU37146

Post-operation care

EWJ00331

WARNING

Always place the watercraft upright in a horizontal position when storing it, otherwise fuel could leak out into the engine or engine compartment, which could create a fire hazard.

After using the watercraft, always take it out of the water, clean it, and store it. Leaving the watercraft in the water for extended periods will accelerate the rate of normal deterioration of the jet pump and hull. Marine organisms and corrosion are some of the conditions that can shorten the life of many watercraft components.

EJU42222

Flushing the cooling water passages

ECJ01311

NOTICE

Do not run the engine over 4000 r/min on land. Also, do not run the engine for more than 15 seconds without supplying water, otherwise the engine could overheat.

Flush the cooling water passages to prevent them from clogging with salt, sand, or dirt.

- (1) Place the watercraft in a horizontal position.
- (2) Remove the seats and removable watertight storage compartment. (See page 49 for seat removal and installation procedures and page 55 for information on the removable watertight storage compartment.)
- (3) Open the stern storage compartment. (See page 54 for information on the stern storage compartment.)

- (4) Connect the garden hose adapter to a garden hose.

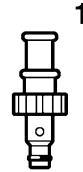

1 Garden hose adapter

- (5) Loosen the flushing hose connector cap and remove it. Insert the garden hose adapter into the flushing hose connector by pushing and twisting it until it is securely connected.

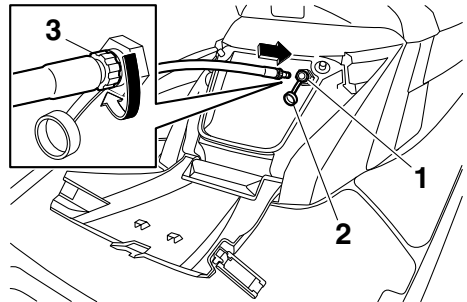

1 Flushing hose connector

2 Flushing hose connector cap

3 Garden hose adapter

- (6) Connect the garden hose to a water tap.
- (7) Make sure that the area around the watercraft is clear, and then start the engine. Immediately after the engine starts, fully turn the water supply on so that wa-

ter flows out continually from the jet thrust nozzle.

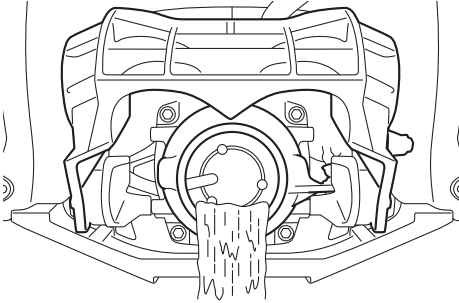

- (8) Run the engine at idling speed for about 3 minutes watching the engine condition. If the engine stops while flushing, turn the water supply off immediately and perform the procedure again from step 7. **NOTICE: Do not supply water to the cooling water passages when the engine is not running. The water could flow back through the muffler into the engine, causing severe engine damage.** [ECJ00123]
- (9) Turn the water supply off.
- (10) Discharge the remaining water out of the cooling water passages by alternately squeezing and releasing the throttle lever quickly for 10 to 15 seconds.
- (11) Stop the engine.
- (12) Remove the garden hose adapter, and then securely install the flushing hose connector cap by tightening it until it stops.
- (13) Securely close the stern storage compartment.
- (14) Securely install the removable watertight storage compartment and seats in their original positions.

EJU33736

Cleaning the watercraft

- (2) Rinse the engine and engine compartment with a small amount of water. **NOTICE: Do not use high-pressure water when rinsing the engine or engine compartment as severe engine damage could result.** [ECJ00572]
- (3) Drain the water from the engine compartment. (See page 62 for information on draining the bilge water.)
- (4) Wipe the engine and engine compartment with a dry cloth.
- (5) Wash down the hull, deck, and jet pump with fresh water.
- (6) Wipe the hull, deck, and jet pump with a dry cloth.
- (7) Wipe all vinyl and rubber components, such as the seats and engine compartment seals, with a vinyl protectant.
- (8) To minimize corrosion, spray metallic parts of the hull, deck, and engine with a rust inhibitor.
- (9) Allow the engine compartment to air dry completely before installing the seats.
- (10) Securely install the seats in their original positions.

EJU33687

Battery care

If the watercraft will not be used for more than a month, remove the battery from the watercraft, check it, and then store it in a cool, dry place.

EWJ00792



Battery electrolyte is poisonous and dangerous, causing severe burns, etc. Electrolyte contains sulfuric acid. Avoid contact with skin, eyes, or clothing.

Antidotes

External: Flush with water.

Internal: Drink large quantities of water or milk. Follow with milk of magnesia, beaten

Care and storage

egg, or vegetable oil. Call a physician immediately.

Eyes: Flush with water for 15 minutes and get prompt medical attention.

Batteries produce explosive gases. Keep sparks, flames, cigarettes, etc., well away. If using or charging the battery in an enclosed space, make sure that it is well ventilated. Always shield your eyes when working near batteries.

Keep out of the reach of children.

To remove the battery:

- (1) Disconnect the negative (-) battery lead.
- (2) Disconnect the positive (+) battery lead.
- (3) Disconnect the breather hose.
- (4) Unhook the battery bands, and then remove the battery from the watercraft.

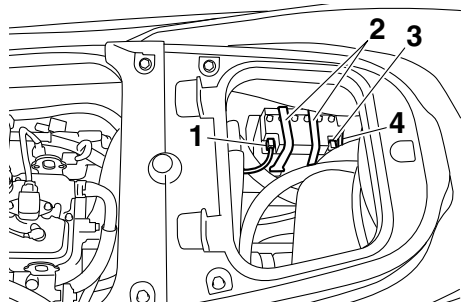

- 1 Negative (-) battery terminal: Black lead
- 2 Battery band
- 3 Positive (+) battery terminal: Red lead
- 4 Breather hose

Checking the battery

- Make sure that the battery case is not damaged.
- Make sure that the battery terminals are not corroded or damaged.
- Make sure that the breather hose is not clogged or damaged.

Checking the electrolyte level

Make sure that the electrolyte level is between the maximum and minimum level marks.

If the electrolyte level is low, add distilled water to raise it to the specified level. **NOTICE:** Use only distilled water for replenishing the battery, otherwise battery life could be shortened. [ECJ00242]

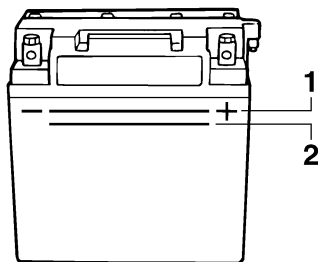

- 1 Maximum level mark
- 2 Minimum level mark

If distilled water was added, check the battery voltage.

It is recommended to have a Yamaha dealer check the battery voltage and charge the battery. If you charge the battery yourself, be sure to read and follow the instructions provided with the battery tester and charger you use. **NOTICE: Do not attempt to charge a battery hastily. Battery life could be shortened.** [ECJ00252]

Checking the battery bands

Make sure that the battery bands are not damaged.

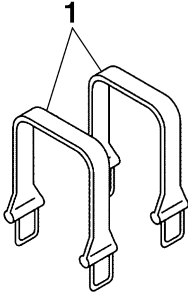

1 Battery band

To store the battery:

- (1) Clean the battery case using fresh water.
- (2) If the battery terminals are dirty or corroded, clean them using a wire brush.

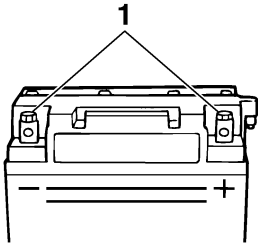

1 Battery terminal

- (3) Apply Yamaha Marine Grease or Yamaha Grease A to the battery terminals.

Recommended water-resistant grease:
Yamaha Marine Grease/Yamaha
Grease A

- (4) Store the battery in a cool, dry place.
NOTICE: Storing the battery in an uncharged condition can cause permanent battery damage. Check the battery periodically. [ECJ00103]

To install the battery:

- (1) Place the battery in the battery compartment and hook the battery bands onto the holders.
- (2) Connect the positive (+) battery lead (red) to the positive (+) battery terminal.
NOTICE: Reversal of the battery leads will damage the electrical parts. [ECJ00262]
- (3) Connect the negative (-) battery lead (black) to the negative (-) battery terminal.
- (4) Connect the breather hose to the battery. **WARNING! Fire or explosion could result if the breather hose is damaged, obstructed, or not connected properly.** [EWJ00452]
- (5) Make sure that the battery is securely held in place.

Care and storage

EJU33493

Long-term storage

EWJ00331

WARNING

Always place the watercraft upright in a horizontal position when storing it, otherwise fuel could leak out into the engine or engine compartment, which could create a fire hazard.

Storage for long periods of time, such as winter storage, requires preventive maintenance to ensure against deterioration. It is advisable to have the watercraft serviced by a Yamaha dealer prior to storage.

However, the following procedures can be performed easily by the owner.

EJU40763

Cleaning

- (1) Flush the cooling water passages. (See page 88 for information on flushing the cooling water passages.)

TIP:

If you will be storing the watercraft for a prolonged period, such as winter storage, top off the fuel tank with fresh gasoline and add fuel stabilizer and conditioner to the fuel tank according to the manufacturer's instruction before starting the engine.

- (2) Clean the watercraft. (See page 89 for information on cleaning the watercraft.)
Wax the hull with a non-abrasive wax.

EJU43301

Lubrication

Use a suitable marine grease applicator and spray a rust inhibitor between the inner and outer cables to lubricate the cables and purge out any dirt and moisture.

To keep moving parts sliding or rotating smoothly, lubricate them with water-resistant grease.

Recommended water-resistant grease:
Yamaha Marine Grease/Yamaha Grease A

- Steering cable (jet thrust nozzle end) and electric trim rod (jet thrust nozzle end)

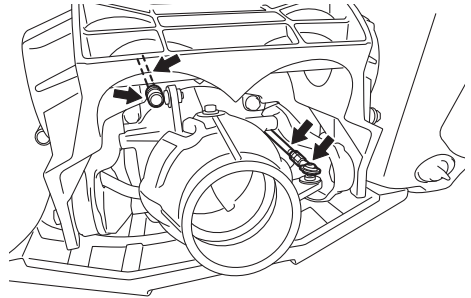

- Shift rod (reverse gate end)

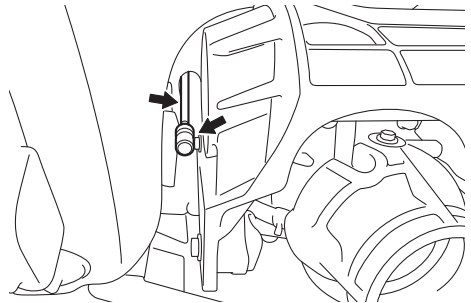

EJU40812

Rustproofing

Spray metallic parts of the hull, deck, and engine with a rust inhibitor.

Have a Yamaha dealer rustproof the internal engine components.

EJU33769

Maintenance

Periodic checks and lubrication will keep your watercraft in the safest and most efficient condition possible. Therefore, make sure to carry out the periodic maintenance. Safety is an obligation of the watercraft owner. Proper maintenance must be carried out to keep the exhaust emission and sound levels within the regulated limits. The most important points of watercraft inspection and lubrication are explained on the following pages.

See a Yamaha dealer for genuine Yamaha replacement parts and optional accessories designed for your watercraft.

Remember, failures that are the result of the installation of parts or accessories which are not qualitatively equivalent to genuine Yamaha parts are not covered by the limited warranty.

Maintenance, replacement, or repair of the emission control devices and system may be performed by any marine SI engine repair establishment or individual. Warranty repair, however, must be performed at an authorized Yamaha marine dealership.

EWJ00312

WARNING

Be sure to turn off the engine when you perform maintenance unless otherwise specified. If you are not familiar with machine servicing, this work should be done by a Yamaha dealer or other qualified mechanic.

EJU33803

Tool kit

A tool kit is included with this watercraft. Place the tool kit in a waterproof bag and al-

ways carry it with you whenever you use the watercraft.

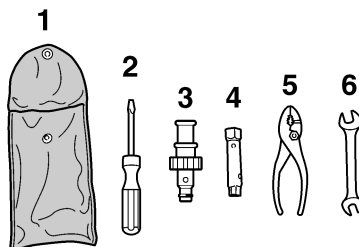

- 1 Tool bag
- 2 Screwdriver
- 3 Garden hose adapter
- 4 10/12 mm box wrench
- 5 Pliers
- 6 10/12 mm open-end wrench

EJU42021

Removing and installing the engine cover

The engine cover is removable.

To remove the engine cover:

- (1) Remove the seats. (See page 49 for seat removal and installation procedures.)
- (2) Remove the engine cover screws.

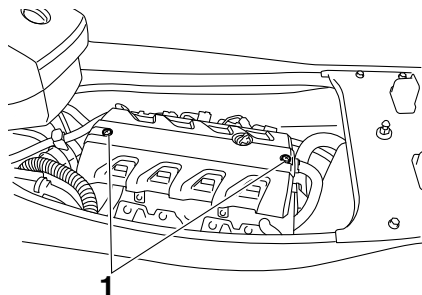

- 1 Engine cover screw

Maintenance

- (3) Lift up the engine cover to remove it.

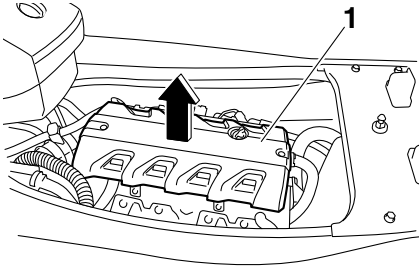

1 Engine cover

To install the engine cover:

- (1) Place the engine cover in its original position, and then push it down.

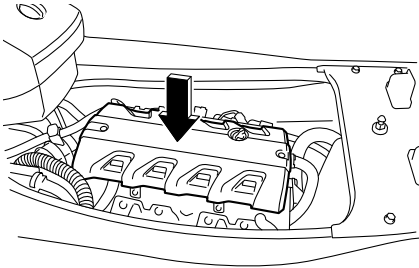

- (2) Install the engine cover screws, and then tighten them to the specified torque.

Tightening torque: Engine cover screw: 4.5 Nm (0.46 kgf-m, 3.3 ft-lb)

- (3) Securely install the seats in their original positions.

EJU43101

Periodic maintenance chart

The periodic maintenance chart gives general guidelines for periodic maintenance. Have a Yamaha dealer perform the checks in the following chart. However, maintenance may need to be performed more frequently depending on your operating conditions. If you have any questions, consult a Yamaha dealer.

This “√” mark indicates items to be checked and serviced by a Yamaha dealer.

Item	Operation	Initial	Thereafter every			Page
		10 hours	50 hours or 12 months *1	100 hours or 12 months *1	200 hours or 24 months *1	
Fuel line	Check fuel hoses and clamps			√		—
Fuel filler cap/Water separator	Check O-rings for cracks and deformation			√		—
Fuel tank	Check installation and straps			√		—
Water inlet strainer	Check for clogs and damage			√		—
Cooling water hoses	Check for damage and leakage, and check clamps			√		—
Engine oil	Replace	√	√			97
Oil filter	Replace			√		97
Intermediate housing	Lubricate			√		—
Spark plugs	Check	√		√		—
Battery	Check state of charge, terminals, bands, and breather hose			√		—
Battery leads	Check terminals			√		—
Steering master	Check operation and for looseness	√		√		—
Steering cable	Check exterior and connections, and lubricate			√		—
Electric trim rod	Check exterior and connections, and lubricate			√		—
Shift rod and reverse gate	Check exterior and connections, and lubricate			√		—
Air filter element	Check for damage and dirt			√		—
Air intake hoses	Check for damage, and check clamps			√		—
Throttle body	Lubricate throttle valves			√		—

Maintenance

Item	Operation	Initial	Thereafter every			Page
		10 hours	50 hours or 12 months *1	100 hours or 12 months *1	200 hours or 24 months *1	
Exhaust system	Check for exhaust leakage, and check hoses and clamps			√		—
Breather hose	Check breather hose and clamps			√		—
Impeller	Check for bends, damage, and foreign material			√		—
Jet thrust nozzle	Check movement, and lubricate			√		—
Jet vacuum bilge	Check hoses for clogs and damage, check clamps, and clean bilge strainer			√		—
Electric bilge pump	Check operation, check hoses for damage, check clamps, and clean bilge pump strainer			√		—
Stern drain plugs	Check O-rings			√		—
Anode	Check for corrosion, and clean				√ *2	—
Valve clearance	Check and adjust				√ *2	—
Rubber coupling	Check for cracks, indentations, looseness, and noise				√	—
Engine mount	Check for damage and peeling				√	—

*1: Whichever comes first.

*2: Check every 200 hours.

Perform the pre-operation checks and post-operation checks before performing periodic maintenance.

EJU36943

Engine oil and oil filter

EWJ00341



Engine oil is extremely hot immediately after the engine is turned off. Coming in contact with or getting any engine oil on your clothes could result in burns.

ECJ00992

NOTICE

Do not run the engine with too much or not enough oil in the engine, otherwise the engine could be damaged.

It is recommended to have a Yamaha dealer change the engine oil and the engine oil filter. However, if you choose to change the oil and filter on your own, consult a Yamaha dealer.

Specifications

EJU34543

Specifications

Watercraft capacity:

Maximum people on board:

3 person

Maximum load capacity:

240 kg (530 lb)

Dimensions and weight:

Length:

3560 mm (140.2 in)

Width:

1230 mm (48.4 in)

Height:

1230 mm (48.4 in)

Dry weight:

376 kg (829 lb) (FX HO)

377 kg (831 lb) (FX Cruiser HO)

Performance:

Maximum output (according to ISO 8665/SAE J1228):

132.4 kW at 7600 r/min

Maximum fuel consumption:

48.7 L/h (12.9 US gal/h, 10.7 Imp.gal/h)

Cruising range at full throttle:

1.44 hour

Trolling speed:

1300 ±100 r/min

Engine:

Engine type:

Liquid cooled 4-stroke, DOHC

Number of cylinders:

4

Engine displacement:

1812 cm³

Bore × stroke:

86.0 × 78.0 mm (3.39 × 3.07 in)

Compression ratio:

11.0 : 1

Valve clearance-intake (cold):

0.14–0.23 mm (0.0055–0.0091 in)

Valve clearance-exhaust (cold):

0.28–0.37 mm (0.0110–0.0146 in)

Lubrication system:

Wet sump

Cooling system:

Water

Starting system:

Electric

Ignition system:

T.C.I.

Spark plug (NGK):

LFR6A

Spark plug gap:

0.8–0.9 mm (0.031–0.035 in)

Battery capacity:

12 V, 19 Ah

Charging system:

Flywheel magneto

Drive unit:

Propulsion system:

Jet pump

Jet pump type:

Axial flow, single stage

Impeller rotation:

Counterclockwise

Jet thrust nozzle angle:

24+24 °

Jet thrust nozzle trim angle:

-6, -3, 0, 3, 6 °

Fuel and oil:

Recommended fuel:

Regular unleaded gasoline

Minimum octane rating (PON):

86

Minimum octane rating (RON):

90

Recommended engine oil:

YAMALUBE 4W or 4-stroke motor oil

Recommended engine oil type SAE:

SAE 10W-30, 10W-40, 20W-40, 20W-50

Recommended engine oil grade API:

API SE,SF,SG,SH,SJ,SL

Fuel tank total capacity:

70 L (18.5 US gal, 15.4 Imp.gal)

Engine oil quantity with oil filter replacement:

3.6 L (3.81 US qt, 3.17 Imp.qt)

Engine oil quantity without oil filter replacement:

3.5 L (3.70 US qt, 3.08 Imp.qt)

Engine oil total quantity:

5.3 L (5.60 US qt, 4.66 Imp.qt)

Trouble recovery

EJU34562

Troubleshooting

If you have any trouble with your watercraft, use the troubleshooting chart to check for the possible cause.

If you cannot find the cause, consult a Yamaha dealer.

EJU43512

Troubleshooting chart

Confirm the possible cause and remedy, and then refer to the applicable page.

TROUBLE	POSSIBLE CAUSE		REMEDY	PAGE
Engine does not start (Starter motor does not turn over)	Yamaha Security System	Lock mode selected	Select unlock mode	27
	Engine shut-off switch	Clip not in place	Install clip	28
	Fuse	Burned out	Replace fuse and check wiring	104
	Battery	Run down	Recharge	89
		Poor terminal connections	Tighten as required	89
		Terminal corroded	Clean or replace	89
	Starter motor	Faulty	Have serviced by Yamaha dealer	—
Engine does not start (Starter motor turns over)	Throttle lever	Squeezed	Release	28
		Faulty	Have serviced by Yamaha dealer	—
	RiDE lever	Squeezed	Release	28
		Faulty	Have serviced by Yamaha dealer	—
	Fuel	Fuel tank empty	Refill as soon as possible	58
		Stale or contaminated	Have serviced by Yamaha dealer	—
	Fuel tank	Water or dirt present	Have serviced by Yamaha dealer	—
	Spark plug	Fouled or defective	Have serviced by Yamaha dealer	—
	Spark plug cap	Not connected or loose	Have serviced by Yamaha dealer	—
		Connected to wrong cylinder	Have serviced by Yamaha dealer	—
	Fuel injection system	Fuel pump faulty	Have serviced by Yamaha dealer	—

Trouble recovery

TROUBLE	POSSIBLE CAUSE		REMEDY	PAGE
Engine runs irregularly or stalls	Fuel	Fuel tank empty	Refill as soon as possible	58
		Stale or contaminated	Have serviced by Yamaha dealer	—
	Fuel tank	Water or dirt present	Have serviced by Yamaha dealer	—
	Spark plug	Fouled or defective	Have serviced by Yamaha dealer	—
		Incorrect heat range	Have serviced by Yamaha dealer	—
		Gap incorrect	Have serviced by Yamaha dealer	—
	Spark plug cap	Not connected or loose	Have serviced by Yamaha dealer	—
		Cracked, torn, or damaged	Have serviced by Yamaha dealer	—
	Electrical wiring	Loose connection	Have serviced by Yamaha dealer	—
Fuel injection system	Faulty or clogged injectors	Have serviced by Yamaha dealer	—	
Warning light or indicator blinks or comes on	Fuel level warning	Fuel tank empty	Refill as soon as possible	58
	Oil pressure warning	Oil pressure dropped	Have serviced by Yamaha dealer	44
	Engine over-heat warning	Jet intake clogged	Clean	102
	Check engine warning	Faulty sensors	Have serviced by Yamaha dealer	45

Trouble recovery

TROUBLE	POSSIBLE CAUSE		REMEDY	PAGE
Watercraft slow or loses power	Watercraft operation mode	Low RPM Mode activated	Deactivate Low RPM Mode	36
	Cavitation	Jet intake clogged	Clean	102
		Impeller damaged or worn	Have serviced by Yamaha dealer	102
	Engine over-heat warning	Engine speed reduction control activated	Clean jet intake and cool engine	44
	Oil pressure warning	Engine speed reduction control activated	Add oil	44
	Spark plug	Fouled or defective	Have serviced by Yamaha dealer	—
		Incorrect heat range	Have serviced by Yamaha dealer	—
		Gap incorrect	Have serviced by Yamaha dealer	—
	Spark plug cap	Not connected or loose	Have serviced by Yamaha dealer	—
	Electrical wiring	Loose connection	Have serviced by Yamaha dealer	—
	Fuel	Stale or contaminated	Have serviced by Yamaha dealer	—
	Air filter	Clogged	Have serviced by Yamaha dealer	—
		Oil buildup	Have serviced by Yamaha dealer	—
	Throttle lever	Faulty	Have serviced by Yamaha dealer	—

Trouble recovery

EJU34625

Emergency procedures

EJU34635

Cleaning the jet intake and impeller

EWJ00783

WARNING

Before attempting to remove weeds or debris from the jet intake or impeller area, shut the engine off and remove the clip from the engine shut-off switch. Severe injury or death could result from coming in contact with the rotating parts of the jet pump.

If weeds or debris gets caught in the jet intake or impeller, cavitation can occur, causing jet thrust to decrease even though engine speed rises. If this condition is allowed to continue, the engine will overheat and may seize. **NOTICE: If weeds or debris gets caught in the jet intake, do not operate the watercraft above trolling speed until they have been removed.** [ECJ00654]

If there is any sign that the jet intake or impeller is clogged with weeds or debris, return to shore and check the intake and impeller. Al-

ways stop the engine before beaching the watercraft.

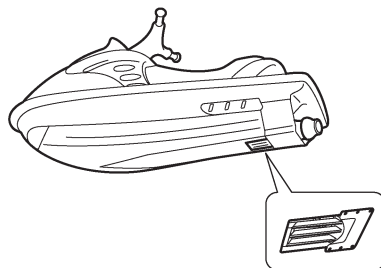
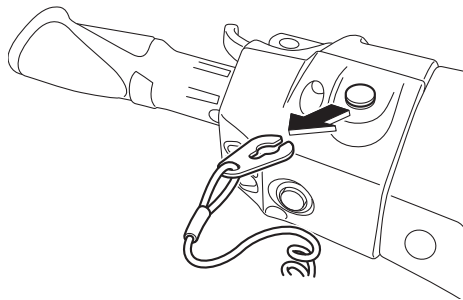

- (1) Place a suitable clean cloth or carpeting underneath the watercraft to protect it from abrasions and scratches. Turn the watercraft on its side as shown. **NOTICE: Always turn the watercraft over onto its port (left) side. When turning the watercraft on its side, support the bow so that the handlebars are not bent or damaged.** [ECJ00662]

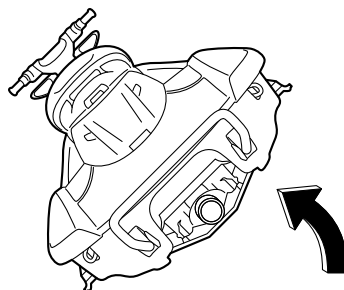

- (2) Remove any weeds or debris from around the jet intake, drive shaft, impeller, jet pump housing, and jet thrust nozzle.

If debris is difficult to remove, consult a Yamaha dealer.

EJU43471

Raising the reverse gate

If the RiDE system malfunctions and the reverse gate remains in the lowered position, the watercraft will not be able to move forward.

After raising the reverse gate so that the watercraft can move forward, immediately return to shore and have a Yamaha dealer service the watercraft.

To raise the reverse gate:

- (1) Stop the engine and remove the clip from the engine shut-off switch.
- (2) Enter the water and move to the rear of the watercraft.
- (3) Slide the shift rod joint toward the bow, and then disconnect the shift rod joint from the ball joint.

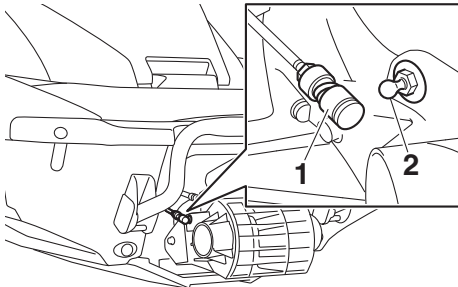

- 1 Shift rod joint
2 Ball joint

- (4) Raise the reverse gate to the forward position.

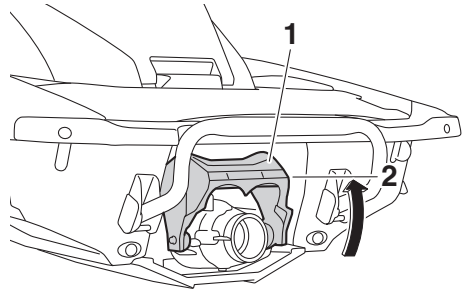

- 1 Reverse gate
2 Forward position

TIP:

- While the shift rod is disconnected, the reverse gate will not move to the neutral position or reverse position even if the RiDE lever is squeezed.
- If the RiDE lever is squeezed while the shift rod is disconnected, the watercraft will move forward.

EJU34642

Jumping the battery

If the watercraft battery has run down, the engine can be started using a 12-volt booster battery and jumper cables.

EJU34664

Connecting the jumper cables

EWJ01251

⚠ WARNING

To avoid battery explosion and serious damage to the electrical system:

- Do not reverse the polarity of the jumper cables when connecting to the batteries.
- Do not connect the negative (-) jumper cable to the negative (-) terminal of the watercraft battery.
- Do not touch the positive (+) jumper cable to the negative (-) jumper cable.

Trouble recovery

- (1) Connect the positive (+) jumper cable to the positive (+) battery terminals of both batteries.
- (2) Connect one end of the negative (-) jumper cable to the negative (-) battery terminal of the booster battery.
- (3) Connect the other end of the negative (-) jumper cable to an engine hanger.

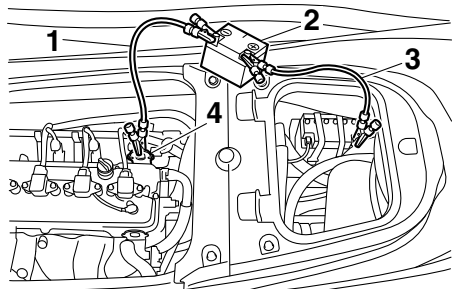

- 1 Negative (-) jumper cable
- 2 Booster battery
- 3 Positive (+) jumper cable
- 4 Engine hanger

- (4) Start the engine, and then disconnect the jumper cables by reversing the steps above. (See page 28 for information on starting the engine.)

EJU43482

Replacing the fuses

If a fuse is blown, replace it with the proper fuse.

1

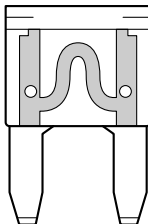

- 1 Good fuse
- 2 Blown fuse

2

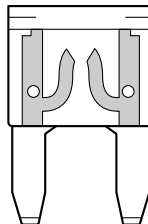

1

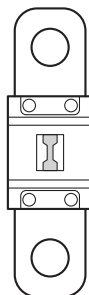

- 1 Good fuse
- 2 Blown fuse

2

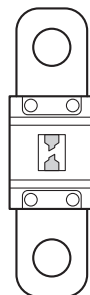

To replace a fuse:

- (1) Remove the seats and removable watertight storage compartment. (See page 49 for seat removal and installation procedures and page 55 for information on the removable watertight storage compartment.)
- (2) While pushing the projection on each lock, slide the locks outward.

Trouble recovery

- (3) Remove the electrical box cover.

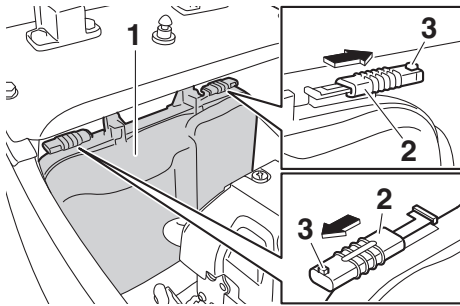

- 1 Electrical box cover
- 2 Lock
- 3 Projection

- (4) While pushing both sides of the fuse box cover inward, pull the cover toward the bow and remove it.

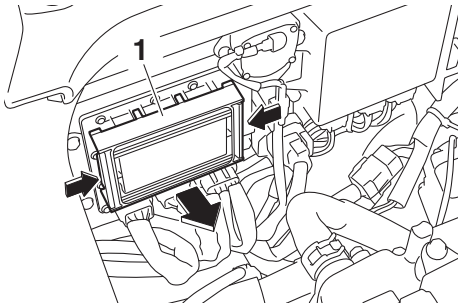

- 1 Fuse box cover

- (5) When replacing the SCU fuse, remove the screws, and then remove the fuse.

Install the spare fuse, and then tighten the screws.

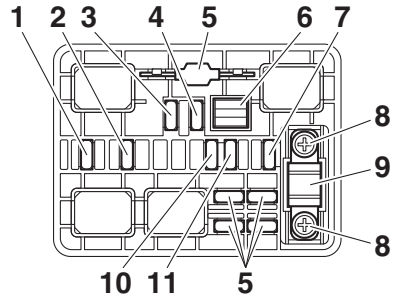

- 1 Electronic throttle valve fuse
- 2 Fuel pump fuse
- 3 Main relay drive fuse
- 4 Main fuse
- 5 Spare fuse
- 6 Fuse puller
- 7 Battery fuse
- 8 Screw
- 9 SCU fuse (BCU fuse)
- 10 Bilge pump fuse
- 11 Security system fuse

- (6) When replacing a fuse other than the SCU fuse, remove the fuse using the fuse puller. Install a spare fuse of the proper amperage. **WARNING! Do not use fuses of a different amperage than recommended. Substitution with a fuse that has an improper rating can cause extensive electrical system damage and possible fire.** [EWJ00803]

Trouble recovery

Fuse amperage:

Electronic throttle valve fuse:

10 A

Fuel pump fuse:

10 A

Main relay drive fuse:

10 A

Main fuse:

20 A

Battery fuse:

30 A

SCU fuse:

50 A

Bilge pump fuse:

3 A

Security system fuse:

3 A

- (7) Securely install the fuse box cover in its original position.
- (8) Securely install the electrical box cover in its original position.
- (9) Slide the locks to their original positions to securely lock the electrical box cover in place.
- (10) Securely install the removable watertight storage compartment and seats in their original positions.

If the fuse immediately blows again, the electrical system may be defective. If this occurs, have a Yamaha dealer service the watercraft.

EJU34716

Towing the watercraft

EWJ00812



WARNING

- The operator of the towing boat must keep speed to a minimum and avoid traffic or obstacles which could be a hazard to the operator on the watercraft.
- The towline should be long enough so that the watercraft will not collide with the towing boat when slowing down.

If the watercraft becomes inoperative in the water, it can be towed to shore.

To tow the watercraft:

Use a towline that is three times the combined length of the towing boat and the watercraft.

- (1) Securely attach the towline to the bow eye of the watercraft being towed.

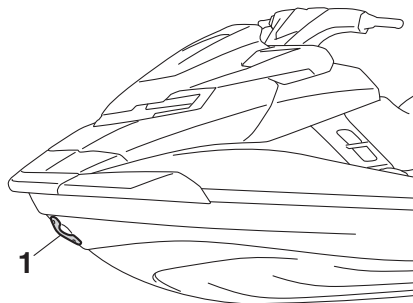

1 Bow eye

- (2) Sit astride the seat and hold on to the handlebars in order to balance the watercraft. **NOTICE: The bow must be kept up out of the water during towing, otherwise water could flood the engine compartment or water could flow back into the engine, causing severe engine damage.** [ECJ01331]

Tow the watercraft at 8 km/h (5 mph) or less.

NOTICE: Tow the watercraft at 8 km/h (5 mph) or less, otherwise water could flood the engine compartment or water could flow back into the engine, causing severe engine damage. [ECJ01322]

EJU36156

Submerged watercraft

If the watercraft is submerged or flooded with water, drain the bilge water from the engine compartment. Then, have a Yamaha dealer service the watercraft as soon as possible.

If the watercraft was submerged:

- (1) Remove the watercraft from the water and drain the water from the storage

compartments. (See page 52 for information on draining the storage compartments.)

- (2) Drain the bilge water from the engine compartment. (See page 62 for information on draining the bilge water.)
- (3) Have the watercraft serviced by a Yamaha dealer as soon as possible.

NOTICE: Be sure to have a Yamaha dealer inspect the watercraft. Otherwise, serious engine damage could result. [ECJ00792]

Index

A			
Adjustable tilt steering system	30	Engine oil level check.....	68
Adjustable tilt steering system checks	70	Engine oil requirements	60
After removing the watercraft from the		Engine overheat warning.....	44
water	87	Engine serial number	1
Analog speedometer/tachometer	40	Engine shut-off cord (lanyard) check	71
B		Engine shut-off switch	28
Battery care.....	89	Engine stop switch.....	28
Battery checks	68	Engine unit check.....	68
Battery, jumping.....	103	Enjoy your watercraft responsibly.....	20
Beaching and docking the watercraft.....	86	Equipment	49
Beverage holders	55	F	
Bilge water check.....	68	Fire extinguisher check	72
Bilge water, draining	62	Fire extinguisher holder and cover.....	57
Bilge water, draining on land	62	Fire extinguisher holder, cover, and	
Bilge water, draining on water	62	band checks	72
Boarding alone.....	82	Flushing the cooling water passages.....	88
Boarding and starting off from a dock.....	85	Fuel	58
Boarding the watercraft	82	Fuel level check.....	67
Boarding with passenger(s)	83	Fuel level meter	43
Bow eye	51	Fuel level warning.....	44
Bow storage compartment	52	Fuel requirements	58
Builder's plate	2	Fuel system checks	67
C		Fuses, replacing	104
Capsized watercraft	85	G	
Check engine warning	45	Getting to know your watercraft	76
Cleaning	92	Glossary, watercraft	21
Cleaning the watercraft.....	89	Glove compartment	53
Cleat.....	51	H	
Cooling water pilot outlet.....	31	Handgrip	50
Cooling water pilot outlet check	73	Hazard information.....	16
Craft Identification Number (CIN).....	1	Hood check.....	73
Cruise assist.....	38	Hour meter/voltmeter	42
Cruising limitations.....	12	Hull and deck check	72
D		I	
Digital speedometer	41	Identification numbers	1
E		Information display.....	41
Electric trim system.....	34	J	
Emergency procedures.....	102	Jet intake and impeller, cleaning.....	102
Engine break-in	64	Jet intake checks	72
Engine compartment check	67	Jet thrust nozzle and reverse gate	
Engine cover, removing and installing	93	check	72
Engine idling speed check	75	Jumper cables, connecting.....	103
Engine oil	60	L	
Engine oil and oil filter	97	Labels, important	4
		Labels, other	9

Labels, warning	5	Riding position	77
Launching the watercraft	77	Rustproofing	92
Learning to operate your watercraft	76	S	
Leaving the watercraft	78	Safe boating rules	19
Limitations on who may operate the watercraft.....	11	Safety equipment check	72
Long-term storage	92	Seats	49
Low RPM Mode	36	Shift indicator.....	46
Lubrication	92	Shift system	32
M		Shift system check.....	74
Main components, location of	22	Start switch	28
Maintenance	93	Starting off	84
Manufactured date label	2	Starting off from a trailer	85
Model information	2	Starting the engine on water.....	77
Multifunction display.....	45	Steering system	29
Multifunction information center	40	Steering system checks	69
Multifunction information center check ...	73	Stern drain plug checks	72
N		Stern eyes	51
No-wake mode	37	Stern storage compartment.....	54
O		Stopping the engine.....	78
Oil pressure warning	44	Stopping the watercraft	80
Operating in weeded areas	86	Storage compartment checks.....	72
Operating the watercraft	78	Storage compartments	52
Operating the watercraft in reverse or neutral.....	81	Submerged watercraft	106
Operating your watercraft	76	Switch checks	71
Operation requirements	13	T	
P		Throttle lever	29
Periodic maintenance chart	95	Throttle lever checks	70
Post-launch checks	73	Tool kit	93
Post-operation care	88	Towing the watercraft	106
Pre-launch checks	67	Transporting on a trailer	63
Pre-operation check points	67	Trim indicator	46
Pre-operation checklist.....	65	Trim indicator check	75
Primary Identification (PRI-ID) number	1	Troubleshooting	99
Pull-up cleats (FX Cruiser HO)	52	Troubleshooting chart.....	99
R		Turning the watercraft.....	79
Raising the reverse gate	103	W	
Reboarding grip	50	Wakeboarding and water-skiing	18
Reboarding step	50	Water separator	31
Recommended equipment	15	Water separator check.....	67
Remote control transmitter	26	Watercraft characteristics	16
Remote control transmitter check	71	Watercraft control functions.....	26
RiDE lever.....	29	Watercraft information	47
RiDE lever checks	70	Watercraft operation functions	32
		Watercraft operation modes	36
		Watertight storage compartments	55

Index

Y

Yamaha Security System.....	27
Yamaha Security System settings	27



Printed in U.S.A.
May 2015-0.4 x 1 CR